



Power of One

IS8000 Integrated Software Platform

Precision Making

Bulletin IS8000-01EN



For over 100 years, Yokogawa has built a reputation on understanding the needs of researchers, scientists, and engineers across the globe. To ensure reliable and trustworthy results, these professionals require accuracy, stability, and reproducibility from their measurement system.

The IS8000 software platform is an integrated solution that accelerates engineering workflow. It is a revolutionary software that tightly integrates the timing, control, and data collection from multiple instruments, creating a comprehensive measurement suite that delivers confidence, efficiency, and unity.

Unity

Unification of Yokogawa instruments ensures measurement coherency during the product development process and allows for effortless data sharing throughout an organization. IS8000 makes it easier to debug and analyze data by viewing all measurements under one unified display.

Efficiency

IS8000 allows you to streamline the product development process by spending less time developing testing systems and more time collecting valuable test data. With one software to setup and control all the instruments you need, you can start measuring data faster and more efficiently.

Synchronization

Storing data in one format and location has never been simpler. IS8000 gives you data you can trust by synchronizing measurements across multiple instruments utilizing an IEEE1588 time base.

Scalability

With today's fast evolving technology, a software that has the ability to expand is crucial. As your needs evolve, so can IS8000. Analyze your data deeper with add-on software packages.

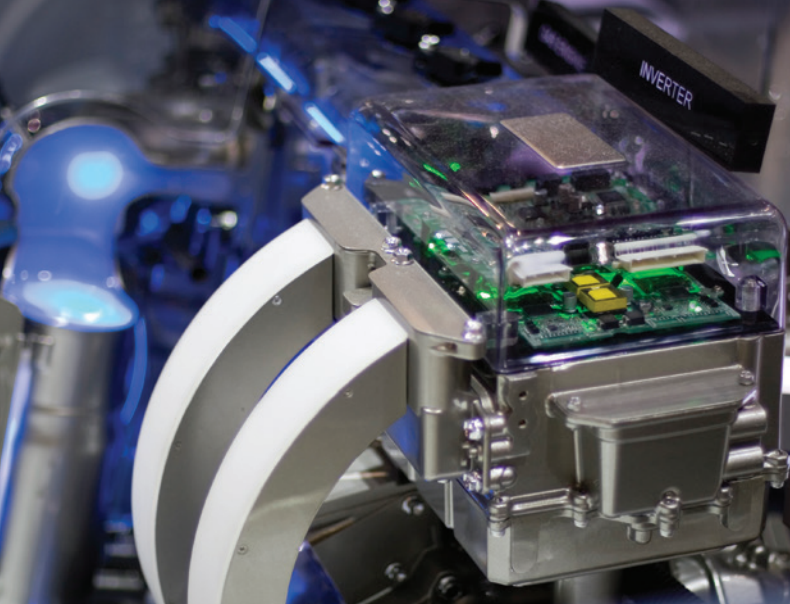

Accelerate Your Engineering Workflow



*This image has been partially processed.

An Intuitive User Interface

1 Ribbon menu

It change depending on which window is active.

2 Numeric display

Numerical data from WT5000 power analyzer can be displayed here.

3 Trend and waveform window

Acquired data from single or multiple devices is displayed simultaneously.

4 Zoom/Pan window

Up to four zoom regions can be defined and displayed simultaneously.

5 Remote control interface

It works with WT5000, DL350/850/950 and DLM3000/5000 series.

6 Recording file list

Name, creation date and file size of the acquired data files are displayed here.

7 FFT Analysis (MH1 option required)

Measure up to 16 FFT processes at same time.

8 High-speed camera images (FS1 option required)

IS8000 can synchronize high-speed video with acquired waveforms.

The Power of One

The IS8000 software platform is an integrated solution that accelerates engineering workflow. It is a revolutionary software solution that tightly integrates the timing, control, and data collection from multiple instruments, creating a comprehensive measurement suite that delivers high confidence, efficiency, and unity.

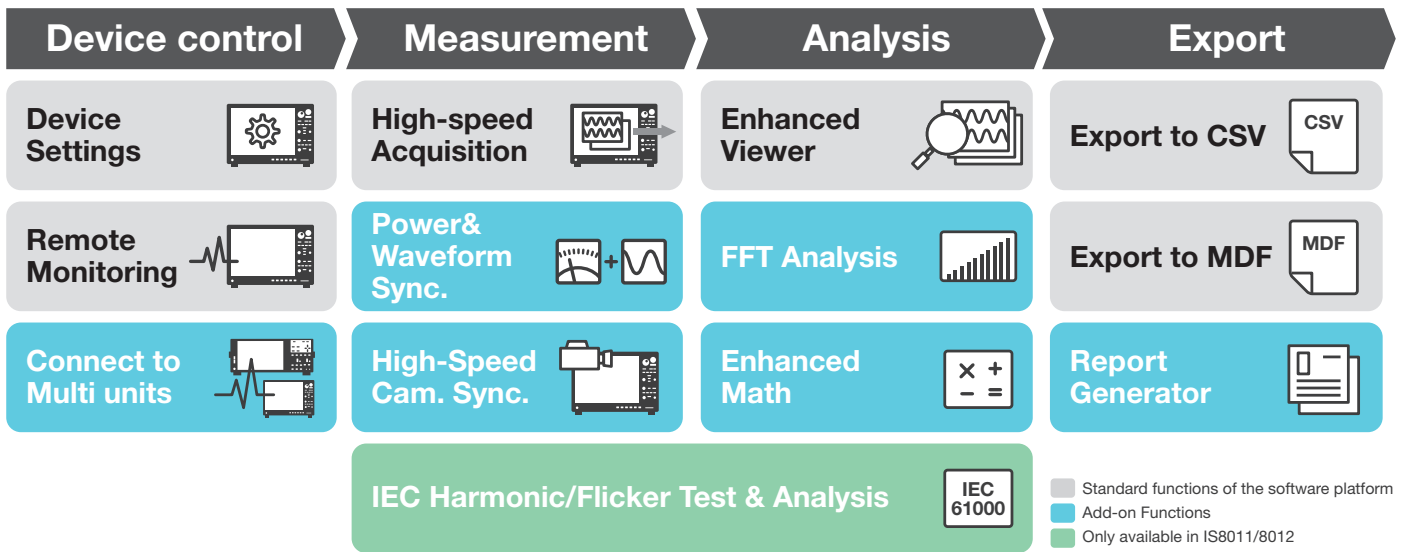

High Speed Data acquisition up to 10 Gb

In combination with the 10 GbE option (C60 option) on the DL950 and the IS8000, up to 8 channels of data can be stored in real time on a PC at a sampling rate of up to 10 M samples per seconds.*
 Longer recording times are now possible for high-speed, multi-channel inputs such as gate signals and switching waveforms of multi-phase inverters.

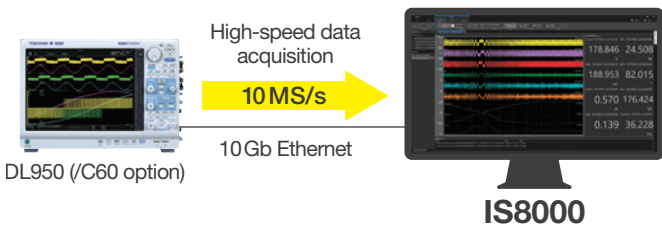

*With 1 Gb Ethernet/USB connection, the maximum transfer rate is 6.4 MB/s (200 kS/s × 16 ch).

Multi-unit Monitoring with Time Synchronization

SY1 option

IS8000 and SY1 option enable accurate power and waveform data synchronization across multiple channels with minimal error. Data from the WT5000 power analyzer and DL950 ScopeCorder is time correlated with less than 10 µs error using IEEE1588 technology.

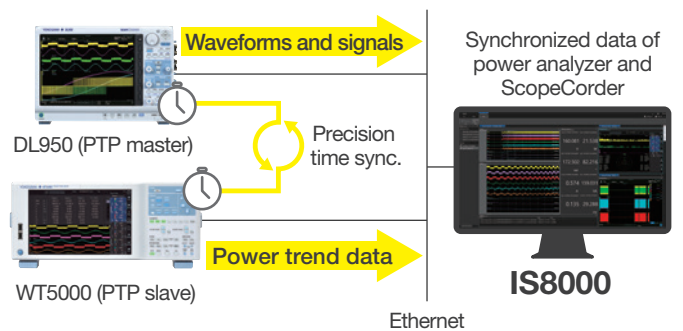

Extensive Measurement data and analysis functions

Control and realtime remote monitoring

YOKOGAWA's high-precision power analyzer, ScopeCorder and oscilloscope can be remotely operated, monitored and configured from IS8000. Additional options, third-party high-speed cameras can also be controlled, greatly reducing the burden of operating and managing various instruments measuring power, physical phenomenon, video, and control signals.



FFT and Math Function

MH1 option

Measure up to 16 FFT processes for a wealth of analysis functions for automatic calculation of frequency and integrated value and filter processing.

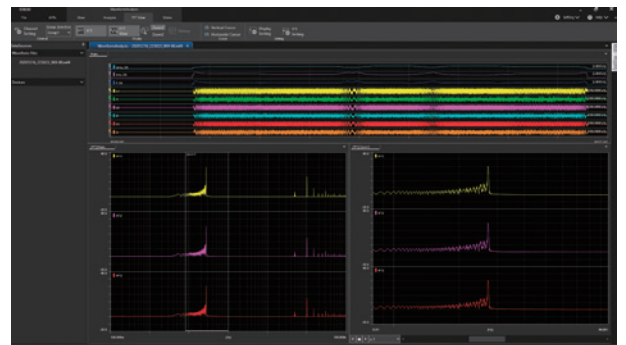

FFT Analysis window

Technology Story : IEEE1588 Precision Time Protocol

IEEE 1588 is a standard for the Precision Time Protocol (PTP), a protocol for high-precision time synchronization of networked instruments and control systems.

The PTP grandmaster server provides a reference clock for each client instrument to achieve high-precision clock synchronization. Since the ScopeCorder DL950 has the PTP master function, high precision clock synchronization of the corresponding instruments on the same network is possible even without a PTP grandmaster server.

The IS8000 is also capable of combining the simultaneous measurement data of each of these PTP-synchronized instruments in the same window.

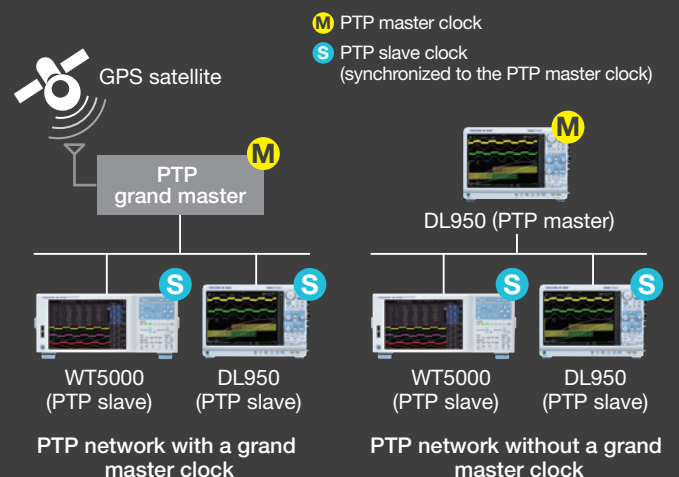

Conveniently export measurement data

Report Generator

RP1 option

Customized reports are easily created by dragging and dropping measurement data, waveforms, graphs, etc. onto the sheet.



File Import and Export

The IS8000 supports binary, ASCII, and the MDF¹ format, a very common format for the automotive industry. Power and waveform data on the IS8000 can be shared with your development system or third-party software.

*1 Import of MDF files generated by other software/devices will be supported in the future.

*2 Power trend data saved by WT5000 is supported only.

File Format	Import	Export
WDF (Binary)	✓	—
CSV (ASCII)	✓*2	✓
MDF (ASAM measurement data format)	✓*1	✓

Synchronization High-speed camera FS1 option

IS8000 synchronizes high speed camera images with related current, voltage, and control signals. Simultaneous slow motion playback allows visualization between design and results.



IS8011/IS8012 Harmonic/Flicker Analysis Software

Optional software package for IEC Harmonic and Flicker compliance test

IS8011/IS8012 optional software package is designed to perform harmonic and flicker tests in accordance with IEC61000-3-2, 3-3, 3-11 and 3-12 standards using the WT5000 precision power analyzer. Users can easily set the conditions and output the test report without any specialized knowledge.

Users can make a pass/fail judgment by class A, B, C, and D of the harmonic current measurement values.

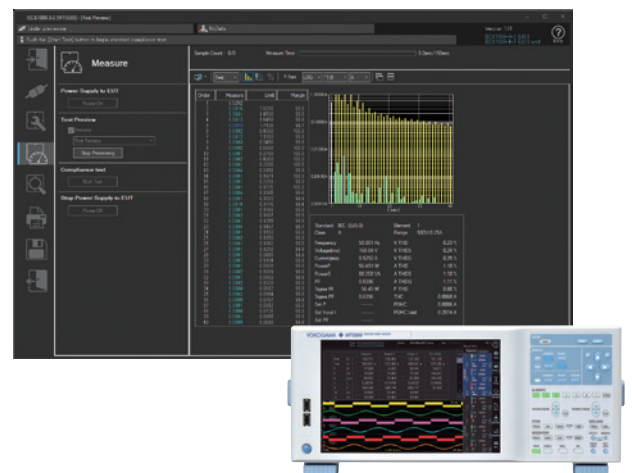

Applications

Evaluate all electrical and mechanical test faster with IS8000

For Automotive and Industrial Industry

Motor Efficiency

Overview

Motor efficiency is a critical measurements for electric vehicles as small improvements can result in increased range. Efficiency measurements require accurate synchronous measurements of power consumption with motor speed and torque.

IS8000 Advantage

High Precision synchronized power and high speed recorder measurements

Data from the WT5000 power analyzer and DL950 ScopeCorder is time correlated with less than 10 μ s error using IEEE1588 PTP technology. Precise power parameters and waveforms are displayed on the same time axis.

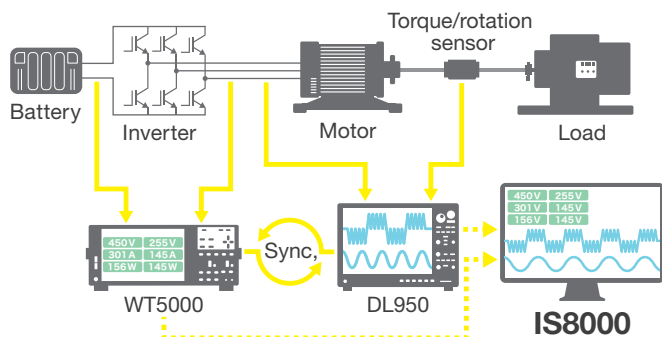

Switching Waveform Analysis for IGBT Inverter

Overview

In order to analyze the motor and inverter system, voltage and current signals between 3 phases, motor I/O signals, and multiple IGBT gate signals are required to properly measure and diagnose system performance and efficiency.

IS8000 Advantage

Combining multiple waveforms

More than 8 waveforms are required to measure inverter performance in a loaded system. IS8000 can connect with multiple 8 channel DLM5000 oscilloscopes for analog and digital signals to scale up to any channel requirement, all in one control and viewing interface.

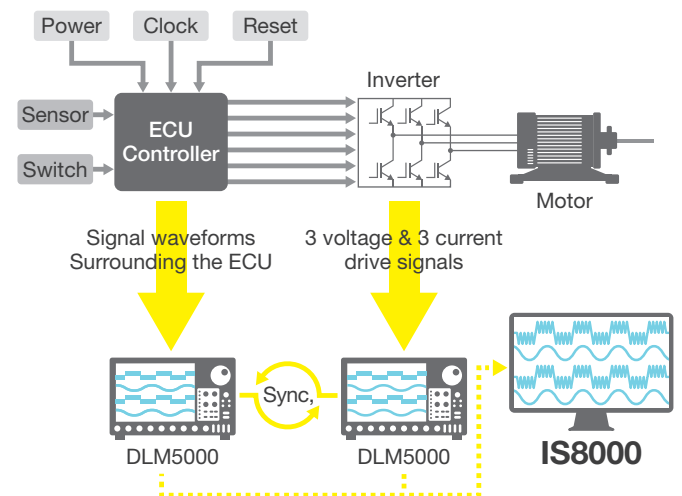

For Power/Energy Industry

Solar/Wind Power System Development

Overview

Renewable energy systems, like wind, solar and hydro must maintain efficiencies through their power conversion stages to decrease their impact on the environment. Multiple measurement points require precision and synchronization.

IS8000 Advantage

View and compare waveforms from multiple instruments

IS8000 can easily synchronize waveforms from multiple instruments, creating an easy view for comparison. Manipulating waveforms is easily done with zoom and pan controls to analyze long records of energy waveforms.

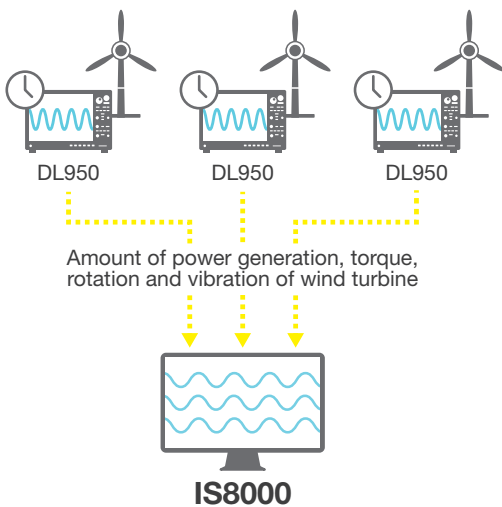

For R&D

Analysis of Robotic Welding Control

Overview

It is necessary to optimize robotic welding conditions for a cost effective manufacturing system. Multiple signals and inputs are required to be monitored in order to determine the best combination between the robot's position and performance, including high speed camera inputs, source voltage and current, and multiple position and control I/O signals.

IS8000 Advantage

Simultaneous recording of multiple signal types

IS8000 displays multiple inputs. The camera image is aligned in time with the other waveform, including the control signals and the voltage and current waveforms. Simultaneous slow motion playback allows visualization between design and results.

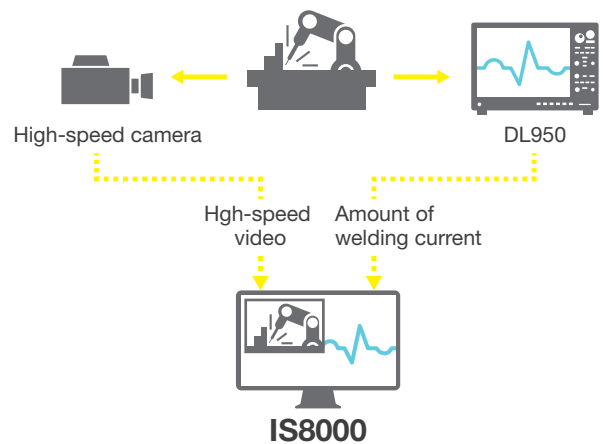

IS8000 compatible Products

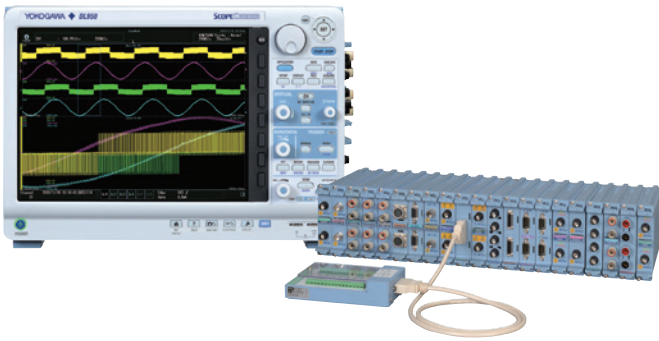

DL950 ScopeCorder

The DL950 combines a mixed signal oscilloscope and portable data acquisition recorder into a single platform which can capture both high speed transient events and long term trends and capable of high-speed, multi-channel measurements up to 200 MS/s and up to 16-bit A/D. With a combination of more than 20 different modules for your application, a single unit can measure isolated analog signals from low voltage to 1000 V, as well as logic signals, vibration and strain, temperature and more. It can also display automotive communication data such as CAN/CAN FD/LIN/SENT as trend waveforms. The 12.1-inch large touch screen enables an intuitive operation. The newly designed application menu makes it easy to set up frequently-used applications. By combining the DL950 with the IS8000, data can be transmitted directly to a PC while measuring, allowing analysis on a PC. Up to five DL950 units can be synchronized with optical fiber cords to measure up to 160 channels simultaneously.



WT5000 Precision Power Analyzer

WT5000 precision power analyzer is a high-precision power meter with a basic power accuracy of $\pm 0.03\%$, one of the best in the world. With a DC power accuracy of $\pm 0.07\%$, a 10 MHz voltage measurement bandwidth, a 5 MHz current measurement bandwidth, and a low power factor characteristic of $\pm 0.02\%$ (of apparent power), the WT5000 provides highly accurate measurements of power consumption, loss, and conversion efficiency of devices. Up to seven power inputs and four motor torque inputs enables simultaneous evaluation of multiple motor drive systems. The WT5000 helps to improve the efficiency of development of EVs, EHV, renewable energy related devices, and energy saving home appliances.

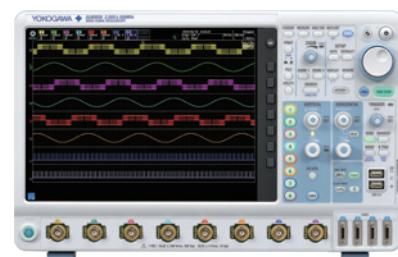

DLM5000 Oscilloscope

The DLM5000 is a mixed-signal oscilloscope with 8 analog channels and 32 bits of logic input on each unit. It is available in two frequency bands, 500 MHz and 350 MHz.

The DLM5000 combines fast sampling rates of up to 2.5 GS/s and a long memory of up to 500 Mpts, making it ideal for a wide range of waveform measurements. A wide variety of triggers, serial bus analysis functions, arithmetic functions and our original "History" functions provide powerful support for waveform measurement operations.

License Types

Subscription License

This licenses type is based on annual subscription renewal for the platform and optional features. Users can purchase the software for as long as they need it, keeping their initial investment to a minimum.

Users will always have the latest version of the software available for the duration of the subscription, so they will always be able to use the latest features, standards and security.

Perpetual License

This is a one-time purchase and can be used indefinitely. Additional optional features can be purchased at a later date. The platform can be upgraded free of charge for up to five years major software version revisions after purchase. After that, users can continue to use the software in the same environment.

This license is suitable for users who do not plan to change their equipment environment at the time of installation.

Activation before using the software

All IS8000 models and licenses, except the free trial period, require software activation over the internet before use. If the PC with the IS8000 installed cannot be connected to the network, it is possible to activate the IS8000 via another network-accessible PC. For more information, please refer to the electronic manual on IS8000 product page.

<https://tmi.yokogawa.com/p/is8000/>

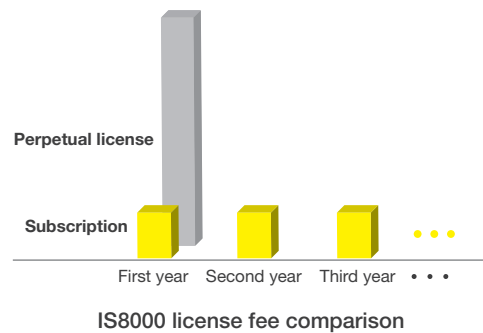

IS8000 Edition, License and Features

Features	Integrated software platform		IEC Harmonic/Flicker Software	
	IS8001 Annual license	IS8002 Perpetual license	IS8011 Annual license	IS8012 Perpetual license
Update to the latest version software	Always	For 5 years	Always	For 5 years
Loading and displaying measurement (WDF) files from Yokogawa Oscilloscopes/ ScopeCorders	✓*	✓	✓*	✓
Loading and displaying power measurement (CSV) files from WT5000	✓*	✓	✓*	✓
Loading and displaying IS8000 acquisition (MF4) files	✓*	✓	✓*	✓
Conversion of the loaded WDF files and measurement data to CSV files	✓	✓		
DLM3000/5000,DL850E/950 remote control and monitoring (for single unit)	✓	✓		
WT5000 remote control (for single unit)	✓*	✓	✓*	✓
WT5000 data collection, monitoring and real-time data transfer (up to 8 items)	✓*	✓	✓*	✓
WT5000 data collection, monitoring and real-time data transfer (more than 9 items)	✓	✓		
DL950 real-time data acquisition (including the high-speed DAQ with 10Gb Ethernet)	✓	✓		
Combining, overlaying and separation of multiple measurement waveforms	✓	✓		
Inter-channel calculation (up to 16ch)	MH1 Option	MH1 Option		
FFT analysis (up to 16ch)	MH1 Option	MH1 Option		
Remote control, monitoring and real-time data acquisition from multiple devices	SY1 Option	SY1 Option		
Synchronized measurement between DL950 and high speed camera	FS1 Option	FS1 Option		
Report generator function	RP1 Option	RP1 Option		
IEC Harmonic / Flicker testing and report creation			✓	✓
Loading, analyzing and report creation of IEC Harmonic / Flicker test data			✓*	✓

*Features available after the subscription ends

Main Specifications

Languages	
English / Chinese** / Japanese (Other languages will be supported in the future)	
System requirement	
Intel Core i7 2.6 GHz or faster / Amount of memory 16 GB or more / Amount of storage 128 GB or more (SSD with M.2 slot is recommended)	
OS	
Windows 10 64 bit	
Communication interface	
USB (USBTMC / VISA), Ethernet (VXI-11 / HiSLIP)	
Number of connectable units (SY1 option)	
2 units / Up to 5 units** (Only 1 unit without SY1 option)	
Supported file formats	
DL/DLM series waveform files (wdf, wvf*), WT1800E*/3000E*/5000 files (csv), Xviewer data files (wdf), IS8000 data files (mf4), IS8000 project files (mepjt, anpjt)	
Export file formats	
MDF files (mf4), ASCII files (csv)	
Online data acquisition	
Supported devices	DL950
Maximum data transfer rate (DL950)	160 MB/s (10 MS/s × 8 ch) with 10 Gb Ethernet 6.4 MB/s (200 kS/s × 16ch) with 1 Gb Ethernet / USB
Maximum recording length	24 hours*2
Maximum recording file size	10 GB/file with 10 Gb Ethernet 50 GB/file with 1 Gb Ethernet/USB
Maximum recording channels	128 channels
Display format	
TY (up to 32 ch for each group, up to 4 group), XY (up to 2 windows for each group), Zoom/Pan (up to 4 areas for each group), Numeric (for WT5000), Trend (for WT5000)	
Waveform overlays	
Aligned by time, absolute time, head of data, end of data or arbitrary position	
Automated waveform parameter measurements	
Cycle Statistics*, History Statistics* and Up to 28 parameters (including P-P, Amp, RMS and Freq).	
Cursor	
Vertical (up to 2 cursor for each window), Horizontal (up to 2 cursor for each window), X-Y**	
Annotation function	
Comments, acquired data and calculated values* can be added on the main/zoom waveform window and X-Y window.	
Supported devices	
Online data acquisition	DL950, WT5000
Remote control and setting, acq. data download	DL350/850 series/950, DLM3000/5000 series, WT5000 (Remote control and setting only)
Data File Import	DL350/750*/850 series/950, SL1400*, SL1000, WT1800E*/3000E*/5000, DLM series
Mathematical data analysis (MH1 option)	
Number of Math channels	Up to 16 channels
Operator	+, -, ×, /, Shift, ABS, SQRT, LOG, EXP, NEG, SIN, COS, TAN, ATAN, PH, DIF, DDF, INTEG, IINTEG, BIN, P2, P3, F1, F2, FV, PWHH, PWHL, PWLL, PWXX, DUTYH, DUTYL, FLT1, FLT2, HLBT, MEAN
Number of computed points	Up to 12.5 Mpoints
Digital filters	Gauss, Sharp, IIR (Butterworth)

FFT analysis (MH1 option)	
Operator	Type: LS, RS, PS, PSD, CS, TF, CH Sub-type: REAL, IMAG, MAG, LOGMAG, PHASE
Window function	Rectangle, Hanning, Flat top, Hamming
Number of FFT channels	Up to 16 channels independently
Number of computed points	Up to 2 M points
Report generator (RP1 option)	
Export file formats	Microsoft Word, Excel, PDF, Print output
High-speed camera Sync. (FS1 option)	
Supported cameras	Photron's FASTCAM SA-Z, NOVA, Mini AX / UX / WX
Supported video format	high-speed camera video files (avi)
Supported devices	DL950

*1: Features will be available in near future.
*2: Further improvements will be implemented with the software update in the future.

Model and Suffix Codes

IS8000 Integrated Software Platform

Model	Code	Description
IS8001		IS8000 Integrated Software Platform Subscription (Annual license)
IS8002		IS8000 Integrated Software Platform Perpetual (Permanent license)
	/SY1	Multi-Unit Synchronization Option
	/MH1	Waveform Math Option
	/RP1	Report Generator Option
	/FS1	High-speed Camera Synchronization Option

Add-on Packages

Model	Code	Description
IS8001EX		IS8000 Add-on Package Subscription (Annual license)
IS8002EX		IS8000 Add-on Package Perpetual (Permanent license)
	-SY1	Multi-Unit Synchronization
	-MH1	Waveform Math
	-RP1	Report Generator
	-FS1	High-speed Camera Synchronization

IS8010 IEC Harmonic/Flicker Measurement Software

Model	Code	Description
IS8011		IEC Harmonic/Flicker Software Subscription (Annual license)
IS8012		IEC Harmonic/Flicker Software Perpetual (Permanent license)

■ Any company's names and product names mentioned in this document are trade names, trademarks or registered trademarks of their respective companies.



YOKOGAWA TEST & MEASUREMENT CORPORATION

Global Sales Dept. /Phone: +81-42-690-8810 E-mail: tm@cs.jp.yokogawa.com
Facsimile: +81-42-690-8826

YOKOGAWA CORPORATION OF AMERICA
YOKOGAWA EUROPE B.V.
YOKOGAWA TEST & MEASUREMENT (SHANGHAI) CO., LTD.
YOKOGAWA ELECTRIC KOREA CO., LTD.
YOKOGAWA ENGINEERING ASIA PTE. LTD.
YOKOGAWA INDIA LTD.
YOKOGAWA ELECTRIC CIS LTD.
YOKOGAWA AMERICA DO SUL LTDA.
YOKOGAWA MIDDLE EAST & AFRICA B.S.C(c)

Phone: +1-800-888-6400 E-mail: tmi@us.yokogawa.com
 Phone: +31-88-4641429 E-mail: tmi@nl.yokogawa.com
 Phone: +86-21-6239-6363 E-mail: tmi@cs.cn.yokogawa.com Facsimile: +86-21-6880-4987
 Phone: +82-2-2628-3810 E-mail: TMI@kr.yokogawa.com Facsimile: +82-2-2628-3899
 Phone: +65-6241-9933 E-mail: TMI@sg.yokogawa.com Facsimile: +65-6241-9919
 Phone: +91-80-4158-6396 E-mail: tmi@in.yokogawa.com Facsimile: +91-80-2852-1442
 Phone: +7-495-737-7868 E-mail: info@ru.yokogawa.com Facsimile: +7-495-737-7869
 Phone: +55-11-3513-1300 E-mail: eproc@br.yokogawa.com
 Phone: +973-17-358100 E-mail: help.ymatmi@bh.yokogawa.com Facsimile: +973-17-336100

<https://tmi.yokogawa.com/>

YMI-KS-MI-SE08

The contents are as of February 2021. Subject to change without notice.
Copyright © 2021, Yokogawa Test & Measurement Corporation
[Ed: 01/b]

Printed in Japan, 102(KP)