

The world's most trusted OSAs

AQ6370 Series
Optical Spectrum Analyzer

Precision Making

Bulletin AQ6370SR-20EN



No longer confined to telecommunications, the emergence of photonics in industrial manufacturing, biological studies, healthcare, lighting, imaging and sensing for safety, security and environmental pollution control is driving the demand for wider ranging wavelengths and higher precision measurement.

Our long experience working with customers in the optical Test & Measurement Industry has enabled us to design the world's most reliable and versatile Optical Spectrum Analyzers. In fact they feature specific technical characteristics that make them the most efficient and effective instruments for measuring devices and systems used in the various applications of photonics.

Yokogawa's AQ6370 OSA Series can satisfy the specific test and measurement needs of R&D and manufacturing centers belonging to any industry.

The AQ6370 OSA Series delivers:

Reliability – The most trusted OSAs in the world thanks to their unmatched measurement accuracy, robustness and proven quality.

Performance – Best in class, state of the art and high-precision instruments that keep pace with the ever changing and quickly evolving optical technology.

Expertise – For more than 30 years, our R&D and Product Specialist teams have been listening to the needs of OSA users to continuously provide them with innovative and effective solutions for their measuring challenges.



40+ years of experience

In 2002 Yokogawa became a leading supplier of optical spectrum analyzers, following the acquisition of Ando Electric. Today, with more than 40 years of experience in optical testing, Yokogawa can offer a full range of OSAs, each one specifically designed to accurately and quickly measure the performance of photonic devices and systems used in diverse applications.

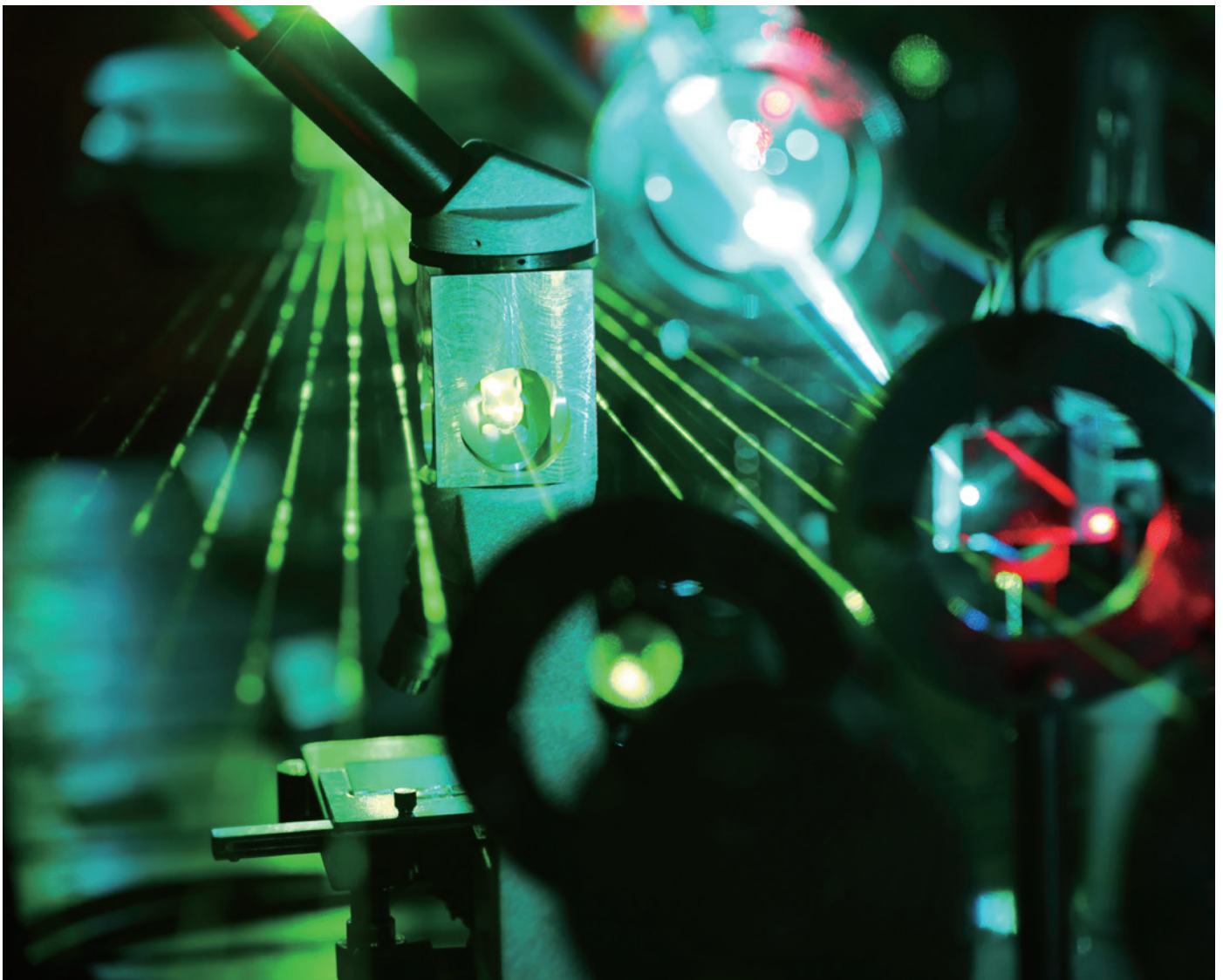

World class optical performance and unique characteristics

The highest resolution (up to 20 pm*) & highest close-in dynamic range (up to 78 dB**)

The advanced monochromator enables the detection of spectral signals which are in close proximity; this allows them to be distinguished and accurately measured.

The highest sensitivity (down to -90 dBm*)

Low-power optical signals can be measured accurately and quickly, without any need to use averaging over many measurements. Moreover, with the *High Dynamic Mode* enabled, the instrument will maximize its dynamic range performance by eliminating the influence of stray-light which increases the noise floor, a disturbing factor for the photodetector caused by strong input signal.

The widest measurement power range (up to 110 dB*)

The high quality photodetector and the smart design of the gain circuitry enable the AQ6370 Series to have an incredibly wide measurement power range. The OSA can analyze very strong signals without being damaged and very weak signals as well, with great accuracy.

* AQ6370E model

** AQ6370E model, typical value

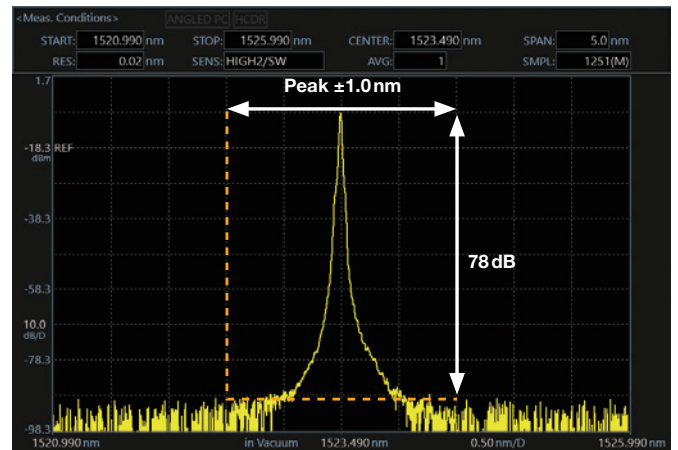

AQ6370E, Peak ± 1.0 nm, resolution setting 0.05 nm, High dynamic mode: ON, High performance model, typical

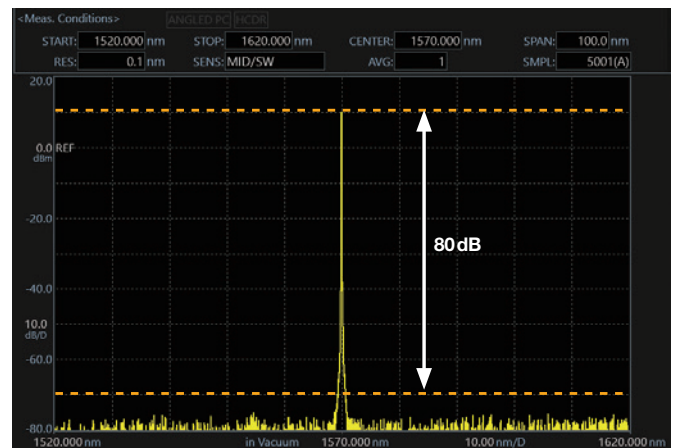

AQ6370E, Sensitivity setting: MID High dynamic mode: ON, typical

The free space optical input

The optical input structure designed for the AQ6370 Series is the most effective to guarantee high coupling efficiency, measurements repeatability, and no maintenance.

The free space optical input is:

- Dual purpose:* accepts both SM and MM (up to 800 μ m core diameter) fibers without the high insertion loss that can be caused by a mismatch between MM and SM fibers
- Versatile:* accepts both PC and APC connectors
- Worry-free:* no internal fiber can be scratched by inaccurate coupling of fibers
- Maintenance-free:* no internal fiber can get dirty

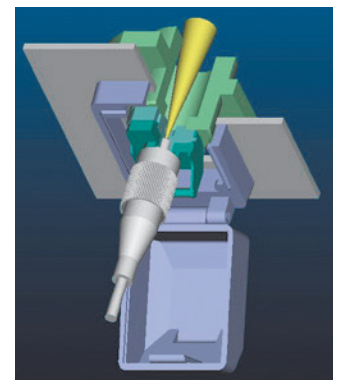

Optical input structure (note. AQ6373B and AQ6377 use fixed connectors)

Gas purging feature

Due to their high resolution and sensitivity, the AQ6370 Series detects the presence of water molecules in the air. The water vapor detected in the upper Near-IR wavelength region could overlay or mask the spectral characteristics of the actual device under test.

The monochromator of AQ6374, AQ6375E, AQ6376E, and AQ6377 models is equipped with a closed-loop circuit for air purging and, by continuously supplying a pure purge gas such as nitrogen (or even just dry air) through the ports on the back panel, the OSA can measure a spectrum which is not affected by the water vapor absorptions.



Purge gas IN/OUT

Built-in cut filter for high order diffracted light

Due to the diffractive technology used, the monochromator in some circumstances could generate high order diffracted light which appears at wavelengths equal to the integral multiple of input wavelengths.

AQ6370 Series OSAs are equipped with a cut-off filter to eliminate artifacts which affect measurement results.



The built-in calibration source

Ambient temperature change, vibrations, and shock affect the measurement accuracy of high precision products such as optical spectrum analyzers. Yokogawa OSAs must be able to deliver the precise measurements for which they were designed; therefore, our instruments are equipped with a light source for calibration.

Calibration process is fully automatic and takes only 2 minutes to complete. It includes:

- The Optical Alignment function, which automatically aligns the optical path in the monochromator to assure the level accuracy;
- The Wavelength Calibration function, which automatically calibrates the spectrum analyzer with the reference source to ensure the wavelength accuracy.

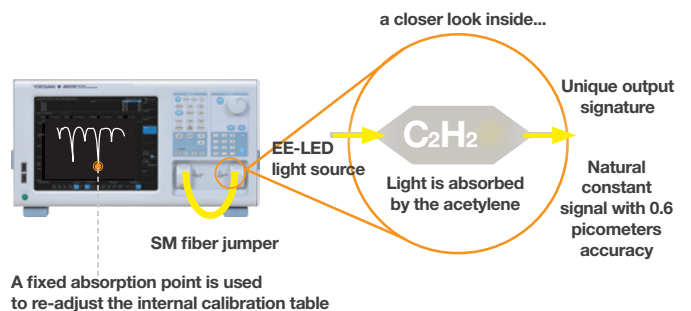

The built-in reference source for wavelength calibration, available for AQ6370E, AQ6374, AQ6375E, AQ6376E and AQ6377.

The greatest flexibility to set parameters

The AQ6370 Series has been designed to guarantee testing flexibility: parameter settings help the user to configure the instrument to obtain the maximum measurement performance according to the specific requirement of each test session.

OSA performance is derived by the following 4 main parameters: Power Sensitivity, Spectral Resolution, Measurement Speed, and Close-In Dynamic Range.

AQ6370 Series users can tune their instrument in order to make it the best performer for the specific application they are about to test. By choosing the right combination of values of the mentioned parameters, the user can adjust the OSA to be extremely fast, or extremely sensitive, or with extremely high resolution.

The user of any AQ6370 Series OSA can set the measurement conditions by choosing:

- 7 level sensitivity values^{*1}
- Up to 10^{-2} wavelength resolution values
- ANY wavelength span^{*2}, including 0 nm span
- ANY number of averaging times from 1 to 999
- ANY number of sampling points from 101 to 200001^{*2, *3}

*1: 6 sensitivities selectable in AQ6375E-01

*2: covered by each model

*3: minimum sampling interval = 1 pm for AQ6370E and AQ6373B, 2 pm for AQ6374 and AQ6375E, 3 pm for AQ6376E, 10 pm for AQ6377



Highly efficient functions to increase productivity

Reducing design and manufacturing costs is a key target for vendors of optical devices.

Test & Measurement instruments for optical devices' evaluation are expected to lower the finished product cost by shortening its inspection time after manufacturing and by increasing productivity of R&D and Production personnel.

Fast measurement at any sensitivity value

With a state-of-the-art monochromator, fast gain circuits, and advanced noise reduction techniques, the AQ6370 series achieves an incredibly fast scanning speed even when measuring low power signals. Double-speed mode increases the sweep speed up to 2 times compared to the standard sweep mode, with only a 2 dB penalty on the standard sensitivity value.

Up to 16* specific data analysis functions

The AQ6370 series OSAs have built-in analysis functions to characterize WDM systems, optical fiber amplifiers, different types of light sources, and filters. The automatic calculation of the major parameters of the device under test will contribute to its fast characterization.

Analysis functions include:

- WDM (OSNR)
- Optical Fiber Amplifier
- DFB-LD
- FP-LD (VCSEL)
- iTLA
- LED
- Spectral Width
- Notch Width
- SMSR
- PMD
- Optical Power
- Color
- Filter Peak
- Filter Bottom
- WDM Filter Peak
- WDM Filter Bottom
- Go/No-Go Judgment

*Each model of the AQ6370 Series has a different list of built-in analysis functions. Discover them into the product-specific sections further on this brochure.

DUT-oriented test apps (APP) simplifies the test process *

Application (APP) mode transforms a versatile OSA into a machine dedicated to a device under test (DUT). APP mode provides a DUT-specific user interface that navigates the user from configuration settings to test result output without the user being aware of the wide variety of OSA settings.

Basic process of test applications



The AQ6370 Series comes pre-installed with several basic applications such as WDM testing, DFB-LD testing, and FP-LD testing. In addition, the application can be downloaded from the Yokogawa website and added to the AQ6370 Series for use.

*Installed in AQ6370E, AQ6375E and AQ6376E



APP menu window

Building automated test systems*

Thanks to the built-in Macro Programming Function, AQ6370 Series models can perform automatic measurements and control external equipment through their remote interfaces.*

GP-IB, RS-232* and Ethernet ports enable the instrument to be remotely controlled by a PC using standard SCPI compatible or proprietary AQ6317-compatible commands. LabVIEW® drivers are also available.

*Except AQ6370E, AQ6375E and AQ6376E

The AQ6370 Viewer

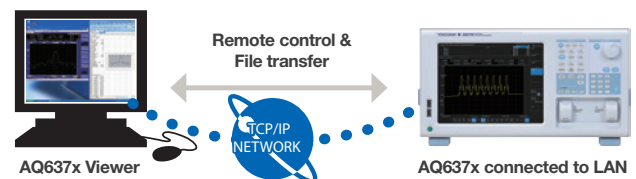

Real-time remote control

With the AQ6370 Viewer, a software package which replicates on your PC the instrument's screen, you can:

- remotely control and operate with the instrument;
- display, analyze and transfer the data acquired by the instrument on your remote PC.

The AQ6370 Viewer is appreciated especially by:

- Production Managers, who can command the instrument and collect its measurement results from their office without physically going to the actual production line.
- Service Engineers, who can help their customers or colleagues pre-setting the instrument, tuning it on the device/system they want to test.

Various features for a comfortable test environment

Large touchscreen LCD

The high-resolution, responsive 10.4-inch multi-touch capacitive touchscreen makes device operation even simpler and more intuitive. You can change measurement conditions, perform analysis, change the optical spectrum view as if you were operating a tablet device. In the optical spectrum view, the waveform view can be zoomed or shifted by a simple tap and drag.



*Except AQ6373B, AQ6374 and AQ6377

Trace calculation and analysis

Seven individual traces

- Simultaneous multi-trace display;
- Calculation between traces (subtraction between traces);
- Max/Min Hold function.



USB ports

Four USB ports in total available on front and back facilitate the use of external devices such as a mouse, keyboard, external hard drives, and memory sticks.

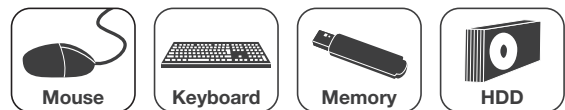

Thumbnail file preview

The thumbnail allows an easy route to quickly find a particular file out of many files in internal and external storage.

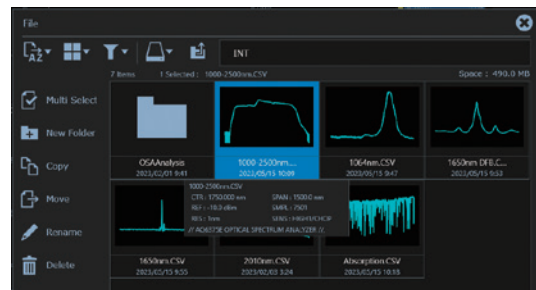

All-at once trace filing

This time-saving feature allows the user to save all seven traces in one file at once. Files are saved in CSV format and can be easily manipulated with a PC application software.

A wealth of functions and connection interfaces

AQ6370 Series

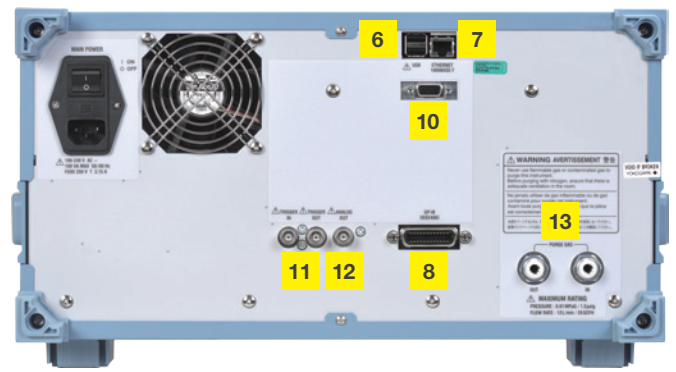

AQ6370E, AQ6375E, AQ6376E

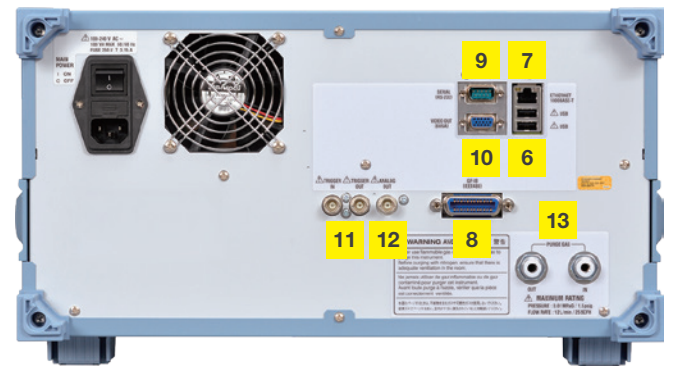
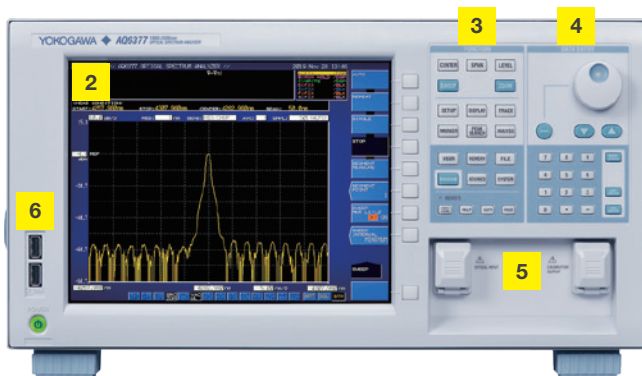

AQ6373B, AQ6374, AQ6377

1 Touchscreen Display

Displays measurement conditions, spectral waveforms, and analysis results. Almost all operations are possible just by the touchscreen.

2 High Resolution Display

A large 10.4-inch SVGA LCD clearly displays detailed waveforms and numerical results. On-screen buttons facilitate the instrument setting through use of the mouse.

3 Function Keys

Main operation menus and shortcuts for commonly used keys.

4 Data Entry

Numeric keypad, up/down keys, and rotary knob for easily and quickly setting various settings, such as measurement parameters, labels, cursor positions.

5 Optical interfaces

The AQ6370E and AQ6374 offer a universal type optical connector system for optical input and calibration output enabling direct coupling to popular styles of optical connectors. The connectors can be replaced by users.

6 USB

Support a USB data storage device, mouse, and keyboard.

7 Ethernet (10/100/1000BASE-TX)

Network interface for remote control, data transfer, and firmware update.

8 GP-IB

Network interface for remote control, data transfer, and firmware update.

9 Serial [RS-232]

Network interface for remote control, data transfer, and firmware update.

10 Video Output (VGA)

Output the instrument screen to an external monitor.

11 Trigger Input and Output

External trigger signal input for the pulsed light test or the recirculating loop experiment

12 Analog Output

Output an analog voltage according to the optical spectrum intensity for the stability test with oscilloscope, etc.

13 Purge Gas Input and Output

Supply and exhaust ports for purge gas circulation to reduce water vapor in the monochromator. [AQ6374, AQ6375E, AQ6376E, and AQ6377]

Typical applications

System test

WDM OSNR test

AQ6370E

AQ6370E's wide close-in dynamic range allows accurate OSNR measurement of DWDM transmission systems. The built-in WDM analysis function analyzes the measured waveform and shows peak wavelength, peak level, and OSNR of WDM signals up to 1024 channels simultaneously. The Curve Fit function is used to accurately measure noise levels.

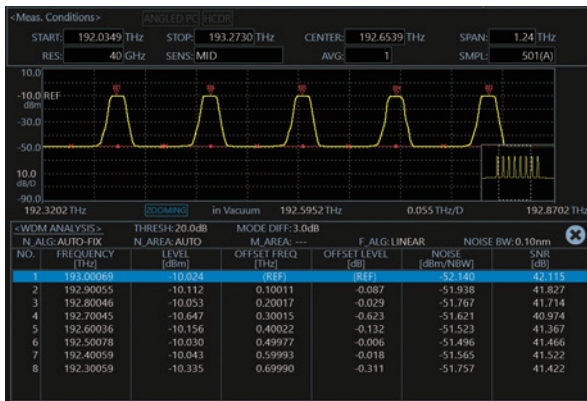
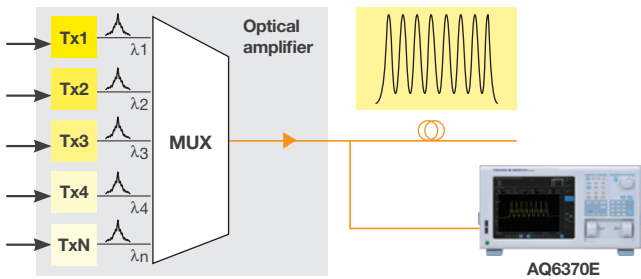

Example of WDM OSNR analysis

Optical amplifier test

AQ6370E

The AQ6370E has an automated function for amplifier analysis under the name "EDFA-NF". Despite the name, it is suitable for characterizing many types of optical amplifiers.

A typical measurement setup for amplifier testing is shown in figure 1. It consists of a set of multiplexed lasers, an attenuator for tuning the laser power level, an optical spectrum analyzer and of the optical fiber amplifier. The set of lasers and the attenuator can be provided by the Yokogawa Multi Application Test System (MATS), which is a modular instrument that allows different configurations for each specific test setup.

The OSA takes two high-resolution recordings of the wavelength range that is covered by the lasers. One trace is taken before amplification and one after amplification. The obtained result will be close to the results shown in figure 2. Immediately it will be noticed that the recorded peaks after amplification will be higher than before amplification. The same holds for the noise levels.

The EDFA-NF Analysis Function automatically detects the laser peaks, extracts the required measurement values, performs the calculations and displays in a table (figure 3) the values of ASE, GAIN and NF of the DUT.

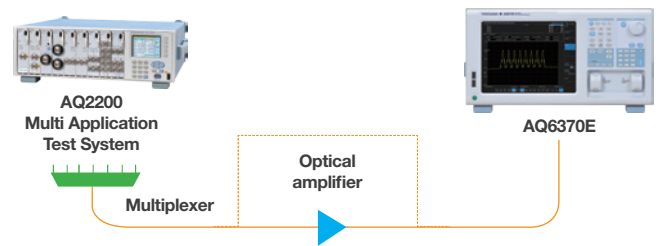

Figure 1 – The typical experimental setup for optical amplifier testing.

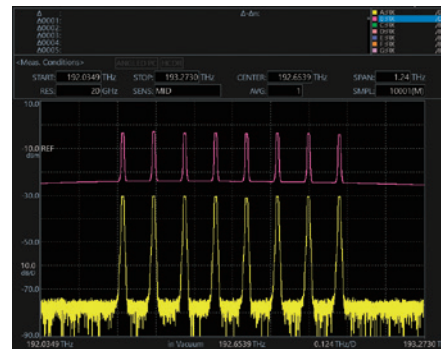

Figure 2 – Typical measurement result showing two traces; one before amplification (yellow) and one after amplification (purple).



Figure 3 – The automated routine for the analysis of optical amplifiers provides a table with their relevant parameters

Active component test

Characterization of laser sources

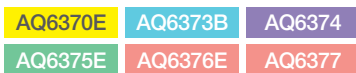

Today, various light sources such as DFB-LD, FP-LD and VCSEL emitting in the visible light to mid-infrared wavelength region are mounted into many different devices/systems that are used in different areas of application, such as:

- **Telecommunication:** with glass fiber or plastic fiber;
- **Industrial:** Barcode scanners, LiDAR surface scanners;
- **Consumer electronics:** audio output of Hi-Fi audio systems, laser printers, computer mice.



Example of DFB-LD analysis (AQ6370E)

stable oscillation in the absorption region in order to achieve sensitive detection of the gas of interest. Most of the greenhouse gases, for example CO₂, SO₂, NO_x and CH₄, have strong absorption lines in the 2-5 μm wavelength region.

The lasers used in Absorption Spectroscopy are DFB-LD and VCSEL. Important parameters for evaluating the performance of these lasers are the Side Mode Suppression Ratio (which is the amplitude difference between the main mode and the side mode), and the Spontaneous Emission level (which is the magnitude of background noise light). Both parameters can be accurately and quickly measured by the AQ6375E and AQ6376E.

Characterization of Supercontinuum light sources

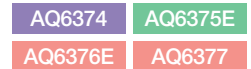

Supercontinuum light is generated by promoting highly nonlinear optical processes in special materials, e.g. photonic crystal fiber, by pumping them with a mode-locked pulsed laser (typically a femtosecond Ti:Sapphire laser). Supercontinuum light can be best described as ‘broad as a lamp, bright as a laser’, in fact it matches the characteristics of incandescent and fluorescent lamps—i.e. very broad spectrum—with the characteristics of lasers—i.e. high spatial coherence and very high brightness, which enables optimum coupling to a fiber, with outstanding single-mode beam quality.

The Supercontinuum light sources are finding applications in a diverse range of fields, including optical coherence tomography, frequency metrology, fluorescence lifetime imaging, optical communications, gas sensing and many others.

The AQ6370 series, due to its premium performance, are the ideal instruments to test and characterize Supercontinuum light sources during their pre and post production quality checks.

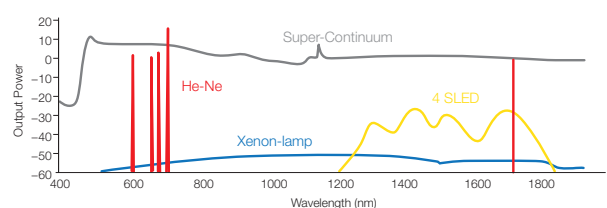

source: <http://www.nktpotonics.com/supercontinuum>

Optical transceiver test

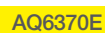

In conjunction with bit error rate test (BERT) equipment, the AQ6370E can measure the center wavelength and spectral width of transceivers and LD modules. Various built-in analysis functions, such as DFB-LD, FP-LD (VCSEL), and LED facilitate the test process.



Characterization of sources used in laser Absorption Spectroscopy

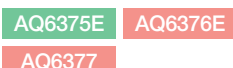

Laser Absorption Spectroscopy is a measurement technique used to detect and measure the concentration of gases in the air, and in an open or closed environment. The lasers used in Absorption Spectroscopy require excellent single-mode operation performance, which directly determines the limits of detection. Furthermore such lasers should produce a

Visible LED test

AQ6373B **AQ6374**

The optical spectrum of visible LEDs used in lighting, signage, sensing, and other applications can be measured and analyzed. By supporting the large core fiber input, AQ6373B and AQ6374 can efficiently get the LED light and measure its spectrum. The built-in Color Analysis function automatically evaluates the dominant wavelength, the chromatic coordinates and the color temperature of the source.

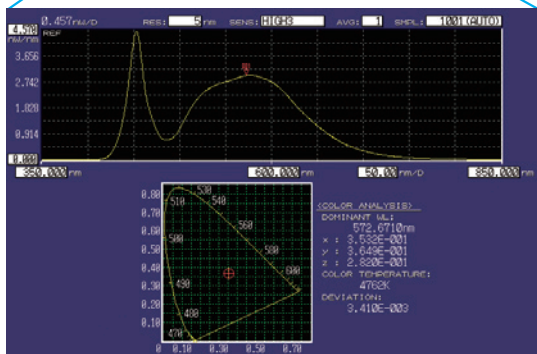
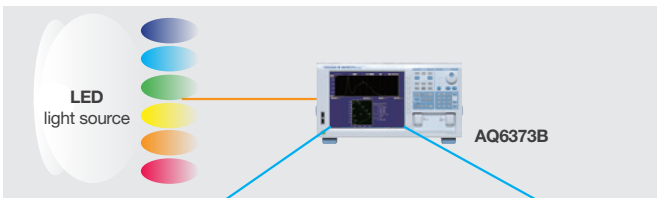

Example of color analysis with AQ6373B

Passive component test

In conjunction with a broadband light source such as ASE, SLD, or SC light source, the OSA can simply perform evaluation of passive devices such as WDM filters, FBG, ROADM, and WSS. Superb optical characteristics of the AQ6370 series enable higher resolution and wider dynamic range measurements. The built-in optical filter analysis function simultaneously reports peak/bottom wavelength, level, crosstalk, and ripple width.

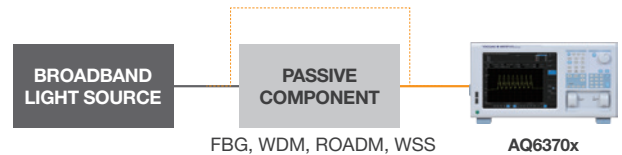

Loss wavelength characterization of optical fibers

AQ6374

The amount of the signal loss in a fiber is dependent on the propagation wavelength. Such dependency is caused by the typical absorption of optical fibers and by the effect of Rayleigh scattering. The material and type of fiber influence the loss values: in the case of a silica single mode fiber, the loss around 1.55 μm is approx. 0.2 dB/km, while around 1.4 μm a bigger loss occurs due to water ions (OH). The loss wavelength characterization of this type of optical fiber requires measurements over a wide range of wavelengths. In combination with a white light source, the AQ6374 efficiently measures losses over a wide range of wavelengths. The loss value is displayed in terms of the loss per unit length of the optical fiber.

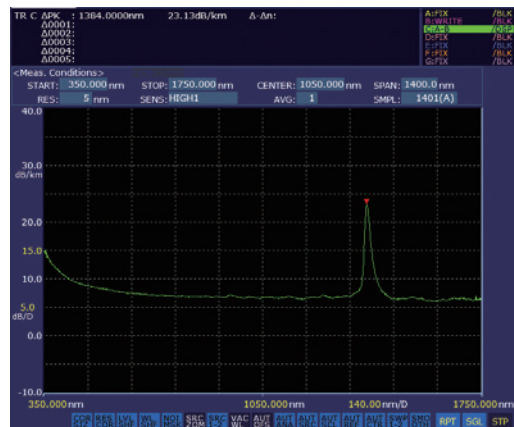

Measurement example of wavelength loss characterization with AQ6374

Characterization of Fiber Bragg Gratings

AQ6370E	AQ6373B	AQ6374
AQ6375E	AQ6376E	AQ6377

A Fiber Bragg Grating (FBG) is a type of distributed Bragg reflector constructed in a short segment of optical fiber that reflects particular wavelengths of light and transmits all the others. This is achieved by creating a periodic variation in the refractive index of the fiber core, which generates a wavelength specific dielectric mirror. A Fiber Bragg Grating can therefore be used as an inline optical filter to block certain wavelengths, or as a wavelength-specific reflector. The primary application of Fiber Bragg Gratings is in optical communications systems: they are specifically used as notch filters and they are also used in optical multiplexers and demultiplexers with an optical circulator, or optical add-drop multiplexer (OADM). Fiber Bragg Gratings tuned on 2-3 μm region are also used as direct sensing elements for strain and temperature in instrumentation applications such as seismology and in pressure sensors for extremely harsh environments. To characterize FBGs, the high wavelength resolution and wide measurement range of the AQ6370 series are indispensable.

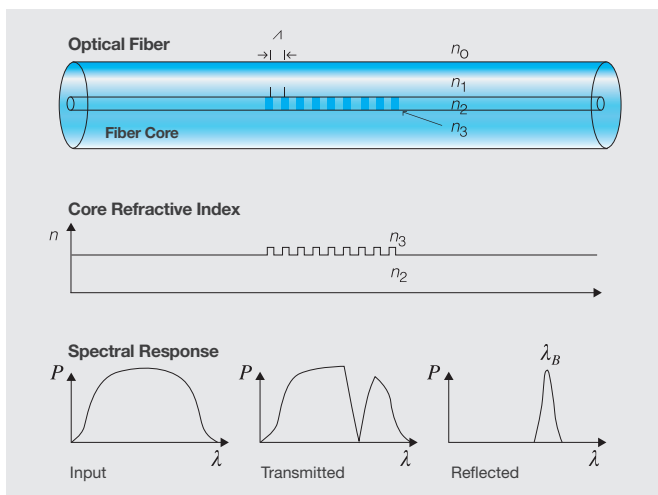

Gas detection and concentration measurements

AQ6370E	AQ6374	AQ6375E
AQ6376E	AQ6377	

Used together with a broadband light source like Super Continuum (SC) or Super Luminescent Diode (SLD), the AQ6370 series can show the absorption spectrum of the gas mixture under test.



Hydrogen Cyanide $\text{H}_{13}\text{C}_{14}\text{N}$ absorption spectrum measurement with AQ6375E

AQ6370E

The OSA market leader in the telecom Industry

Its flexibility in parameters' setting and its unmatched performance make the AQ6370E model the best choice for R&D and Production of optical communication devices.

Features

Standard and High performance models

There are two models available, with the High performance model providing even higher wavelength accuracy and dynamic range.

Wavelength range: 600 to 1700 nm

Due to its broad wavelength range coverage, AQ6370E is suitable to test devices designed for single-mode as well as multimode transmissions.

7 wavelength resolution settings: 20 pm to 2 nm

Enables the user to choose the best value according to the characteristics of the DUT.

7 level sensitivity settings: down to -90 dBm

Enables the user to choose the best value according to test applications and measurement speed requirements.

Up to 2x faster measurement: SMSR mode

The SMSR mode is the sensitivity setting dedicated for measuring the laser's SMSR faster. It can measure the SMSR up to twice as fast as the conventional sensitivity mode (TRAD MIDx2).

Note: Fast measurement may not be possible depending on the level of the optical spectrum.



APC connector level correction function

Corrects the level offset caused by the higher insertion loss of Angled PC connectors.

Resolution calibration function

Calibrates the resolution bandwidth with an external light source. With this new feature, the measurements of power spectral density of a broad spectrum light source will be more accurate.

High wavelength accuracy: ± 0.008 nm typ.

The high wavelength accuracy is achieved in the S, C, and L bands. The AQ6370E also has the high wavelength accuracy of ± 0.1 nm over the whole wavelength range. The high wavelength accuracy can be maintained by calibrating with the wavelength reference source (optional) or the external light source.

Wavelength range	Standard (-10)	High performance (-20)
1520 to 1580 nm	± 0.015 nm	± 0.008 nm
1450 to 1520 nm 1580 to 1620 nm		± 0.015 nm

Note: The wavelength accuracy values in the table are typical values.

High close-in dynamic range: 78 dB typ.

The AQ6370E monochromator has sharp spectral characteristics, so signals in close proximity can be clearly separated and accurately measured.

Sharper spectrum measurement: HCDR mode

The HCDR (High Close-in Dynamic Range) mode is a feature for single longitudinal mode laser measurements that makes the spectrum around the peak sharper and the side modes more clearly visualized.

This mode is only available on the High performance model (-20).

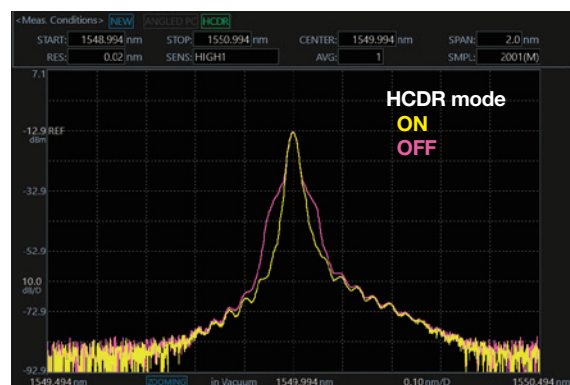

Example of HCDR mode
Resolution setting 0.02 nm, High performance model

Specifications

Items		Specifications	
Spec-code		Standard (-10)	High performance (-20)
Wavelength range ^{*1}		600 to 1700 nm	
Span ^{*1}		0.1 nm to 1100 nm (Full span), and 0 nm	
Wavelength accuracy ^{*1, *2, *5}		±0.02 nm (1450 to 1620 nm, ±0.015 nm typ.) ±0.10 nm (Full range)	±0.01 nm (1520 to 1580 nm, ±0.008 nm typ.), ±0.02 nm (1450 to 1520 nm, 1580 to 1620 nm, ±0.015 nm typ.), ±0.10 nm (Full range)
Wavelength linearity ^{*1, *2, *5}		±0.01 nm (1520 to 1580 nm), ±0.015 nm (1450 to 1520 nm, 1580 to 1620 nm)	
Wavelength repeatability ^{*1, *2}		±0.005 nm (1 min.)	
Wavelength resolution setting ^{*1, *2}		0.02, 0.05, 0.1, 0.2, 0.5, 1 and 2 nm	
Wavelength resolution bandwidth accuracy ^{*1, *2}		±5% (1450 to 1620 nm, Resolution setting: ≥ 0.1 nm, after performing the Resolution Calibration function, at the wavelength of resolution calibration)	
Min. sampling resolution ^{*1}		0.001 nm	
Number of sampling		101 to 200001, AUTO	
Level sensitivity setting	TRAD mode	NORM_HOLD, NORM_AUTO, NORMAL, MID, HIGH1, HIGH2, HIGH3	
	SMSR mode	MID/SMSR, HIGH1/SMSR	
High dynamic mode		SWITCH (Sensitivity: MID, HIGH1-3)	
Level sensitivity ^{*2, *3, *4, *7}		-90 dBm (1300 to 1620 nm), -85 dBm (1000 to 1300 nm), -60 dBm (600 to 1000 nm) (Sensitivity: HIGH3)	
Maximum input power ^{*2, *3}		+20 dBm (Per channel, full range)	
Maximum safe input power ^{*2, *3}		+25 dBm (Total input power)	
Level accuracy ^{*2, *3, *4, *6}		±0.4 dB (1310/1550 nm, Input level: -20 dBm, Sensitivity: MID, HIGH1-3)	
Level linearity ^{*2, *3}		±0.05 dB (Input level: -50 to +10 dBm, Sensitivity: HIGH1-3)	
Level flatness ^{*2, *3, *6}		±0.1 dB (1520 to 1580 nm), ±0.2 dB (1450 to 1520 nm, 1580 to 1620 nm)	
Polarization dependence ^{*2, *3, *6}		±0.05 dB (1550/1600 nm), ±0.08 dB (1310 nm)	
Dynamic range ^{*1, *2, *8}	Resolution: 0.02 nm	55 dB (Peak ±0.2 nm), 37 dB (Peak ±0.1 nm)	58 dB (Peak ±0.2 nm, 60 dB typ.), 45 dB (Peak ±0.1 nm, 50 dB typ.)
	Resolution: 0.05 nm	73 dB (Peak ±1.0 nm), 62 dB (Peak ±0.4 nm), 45 dB (Peak ±0.2 nm)	73 dB (Peak ±1.0 nm, 78 dB typ.), 64 dB (Peak ±0.4 nm, 70 dB typ.), 50 dB (Peak ±0.2 nm, 55 dB typ.)
	Resolution: 0.1 nm	57 dB (Peak ±0.4 nm), 40 dB (Peak ±0.2 nm)	60 dB (Peak ±0.4 nm, 67 dB typ.), 45 dB (Peak ±0.2 nm, 50 dB typ.)
Stray-light suppression ratio ^{*7, *10}		73 dB	76 dB (80 dB typ.)
Optical return loss ^{*11}		35 dB typ. (with angled-PC connector)	
Applicable fiber		SM (9.5/125), MM (GI 50/125, GI 62.5/125, Large core: up to 200 μm)	
Optical connector		Optical input: AQ9447 (□□) Connector adapter (option) required. Calibration output: AQ9441 (□□) Connector adapter (option) required. (□□) Connector type FC or SC	
Built-in calibration light source ^{*12}		Wavelength reference source (For optical alignment and wavelength calibration)	
Sweep time ^{*1, *7, *9}		NORM_AUTO: 0.2 s, NORMAL: 1 s, MID: 2 s, HIGH1: 5 s, HIGH2: 20 s, HIGH3: 75 s	
Warm-up time		Minimum 1 hour (After warming up, optical alignment adjustments required.)	

*1: Horizontal scale: Wavelength display mode.

*2: With 9.5/125 μm single mode fiber with a PC type connector, after 1 hour of warm-up, after optical alignment with built-in reference light source or a single longitudinal mode laser (wavelength 1520 to 1560 nm, peak level ≥ -20 dBm, level stability ≤ 0.1 dBpp, and wavelength stability ≤ ±0.01 nm).

*3: Vertical scale: Absolute power display mode, resolution setting: ≥ 0.05 nm, resolution correction: OFF.

*4: With 9.5/125 μm single mode fiber (B1.1 type defined on IEC60793-2, PC polished, mode field diameter: 9.5 μm, NA: 0.104 to 0.107).

*5: After wavelength calibration with built-in reference light source or a single longitudinal mode laser (wavelength 1520 to 1560 nm, peak level ≥ -20 dBm and absolute wavelength accuracy ±0.003 nm).

*6: Temperature condition changes to 23 ±3°C at 0.05 nm resolution setting.

*7: High dynamic mode: OFF, pulse light measurement mode: OFF, resolution correction: OFF.

*8: 1523 nm, high dynamic mode: SWITCH, resolution correction: OFF

*9: Span: ≤ 100 nm, number of sampling: 1001, average number: 1.

*10: With He-Ne laser (1523 nm), 0.1 nm resolution setting, 1520 nm to 1620 nm except for peak wavelength ±2 nm.

*11: With Yokogawa's master single mode fiber with an angled-PC connector. 15 dB typ. with PC connector.

*12: Option.

"Typical" or "typ." in this document means "Typical value", which is for reference, not guaranteed specification.

AQ6373B

The high-performance model optimized for visible light measurement

Due to its ability to provide high speed, accurate analysis of the wavelength range between 350 nm and 1200 nm, the AQ6373B is well suited for a broad range of applications.

Features

Wavelength Range: 350 to 1200 nm

10 wavelength resolution settings: 10 pm to 10 nm

Enables the user to choose the best value according to the device/system under test.



405 nm FP-LD measurement
(resolution setting: 0.01 nm)

Wide measurable level range: -80 dBm to +20 dBm

Suitable to measure high power as well as low power sources used in different fields of application.

Wavelength accuracy: ± 0.05 nm

The wavelength accuracy can be maintained by the calibration using an external light source including HeNe laser and Argon light source.

Close-in dynamic range: 60 dB

Special optical free space input

suitable also for LARGE-CORE fibers, up to 800 μm .

Smoothing function

Reduces the noise on the measured spectrum.

Color analysis function

Enables the AQ6373B to show the chromatic coordinates of the light source under test.

Specifications

Items	Specifications
Wavelength range ^{*1}	350 to 1200 nm
Span ^{*1}	0.5 nm to 850 nm (Full span), and 0 nm
Wavelength accuracy ^{*1}	± 0.05 nm (633 nm), ± 0.2 nm (400 to 1100 nm) (After wavelength calibration with 633 nm He-Ne laser.)
Wavelength resolution setting ^{*1, *2}	0.02, 0.05, 0.1, 0.2, 0.5, 1, 2, 5, 10 nm (Full range), and 0.01 nm (400 to 470 nm)
Minimum sampling resolution ^{*1}	0.001 nm
Number of sampling	101 to 50001, AUTO
Level sensitivity setting	NORM_HOLD, NORM_AUTO, NORMAL, MID, HIGH1, HIGH2 and HIGH3
High dynamic mode	SWITCH (Sensitivity: MID, HIGH1-3)
Level sensitivity ^{*3}	-80 dBm (500 to 1000 nm), -60 dBm (400 to 500 nm, 1000 to 1100 nm) (Typical, Resolution setting: ≥ 0.2 nm, Averaging: 10 times, Sensitivity: HIGH3)
Maximum safe input power ^{*3}	+20 dBm (550 to 1100 nm), +10 dBm (400 to 550 nm) (Total input power)
Level accuracy ^{*2}	± 1.0 dB (850 nm, Input level: -20 dBm, Resolution setting: ≥ 0.2 nm, Sensitivity: MID, HIGH1-3, SMF [MFD 5 μm @850 nm, NAO.14])
Level linearity ^{*3}	± 0.2 dB (Input level: -40 to 0 dBm, Sensitivity: HIGH1-3)
Dynamic range ^{*1, *5}	60 dB (Peak ± 0.5 nm, Resolution: 0.02 nm, 633 nm)
Applicable fiber	SM, MM (GI 50/125, GI 62.5/125, Large core: up to 800 μm)
Optical connector	FC type (Optical input and Calibration output)
Built-in calibration light source	Optical alignment source (For optical alignment. Wavelength reference is not equipped.)
Sweep time ^{*1, *4}	NORM_AUTO: 0.5 s, NORMAL: 1 s, MID: 2 s, HIGH1: 5 s, HIGH2: 20 s, HIGH3: 75 s
Warm-up time	Minimum 1 hour (After warming up, optical alignment adjustment with built-in light source required.)

Performance and functions can be limited by type of used fiber. The specifications are only guaranteed when a single mode fiber in which light travels in single mode at measured wavelength is used. In case that measured wavelength is less than the cut-off wavelength of the used fiber, or a multimode fiber is used, a measured spectrum may be inaccurate due to a speckle noise. Please be cautious especially when measuring high coherency sources like gas laser and Laser diode.

*1: Horizontal scale: Wavelength display mode.

*2: Actual wavelength resolution varies according to a measured wavelength. Actual resolution at 10 nm resolution setting is about 8 nm at most.

*3: Vertical scale: Absolute power display mode.

*4: High dynamic mode: OFF, number of sampling: 1001, average number: 1, span: ≤ 100 nm excluding 450 to 470 nm and 690 to 700 nm.

*5: High dynamic mode: SWITCH, fiber core size: SMALL

AQ6374

Wide range model covering from visible light to communications wavelength

The AQ6374 covers a wide range of wavelengths from 350 to 1750 nm including the visible (from 380 to 780 nm) and communications regions.

Features

Wavelength range: 350 to 1750 nm

8 wavelength resolution settings: 0.05 to 10 nm

Enables the user to choose the best value according to the device/system under test.

Wide measurable level range: -80 to +20 dBm

Suitable to measure high power as well as low power sources used in different fields of application.

Wavelength accuracy: ± 0.05 nm

The wavelength accuracy can be maintained by the calibration using the built-in reference light source or an external light source including HeNe laser and Argon light source.

Close-in dynamic range: 60 dB

Fast measurement

The instrument takes only 0.5 s for 100 nm span (with sensitivity set to NORM_AUTO).

Number of sampling: 100001

The number of wavelength samples has been doubled. One sweep can measure a wider wavelength range at high resolution.

16 data analysis functions

DFB-LD analysis, Optical filter analysis, color analysis etc.

Purge feature

Built-in cut filter for high order diffracted light

The AQ 6374 automatically sets an internal optical filter according to the measurement wavelength range. The filter drastically reduces the influence of high order diffracted light on the measurement.

Other's functions

Data logging, smoothing and horizontal scale also in wave number (cm^{-1})

Specifications

Items	Specifications
Wavelength range ^{*1}	350 to 1750 nm
Span ^{*1}	0.5 nm to 1400 nm (Full span), and 0 nm
Wavelength accuracy ^{*1,*2,*5}	± 0.05 nm (633 nm) (After wavelength calibration with 633 nm He-Ne laser.), ± 0.05 nm (1523 nm), ± 0.20 nm (Full range)
Wavelength repeatability ^{*1,*2,*5}	± 0.015 nm (1 min.)
Wavelength resolution setting ^{*1,*2}	0.05, 0.1, 0.2, 0.5, 1, 2, 5, 10 nm
Minimum sampling resolution ^{*1}	0.002 nm
Number of sampling	101 to 100001, AUTO
Level sensitivity setting	NORM_HOLD, NORM_AUTO, NORMAL, MID, HIGH1, HIGH2 and HIGH3
High dynamic mode	SWITCH (Sensitivity: MID, HIGH1-3)
Level sensitivity ^{*2,*3,*6}	-80 dBm (900 to 1600 nm), -70 dBm (400 to 900 nm) (Sensitivity: HIGH3)
Maximum safe input power ^{*2,*3}	+20 dBm (550 to 1750 nm), +10 dBm (400 to 550 nm) (Total input power)
Level accuracy ^{*2,*3,*4}	± 1.0 dB (1550 nm, Input level: -20 dBm, Sensitivity: HIGH1-3)
Level linearity ^{*2,*3}	± 0.2 dB (Input level: -40 to 0 dBm, Sensitivity: HIGH1-3)
Polarization dependence ^{*2,*3,*4}	± 0.15 dB (1550 nm)
Dynamic range ^{*1,*2,*8}	60 dB (Peak ± 1.0 nm, Resolution: 0.05 nm, 633 nm/1523 nm)
Applicable fiber	SM (9.5/125), MM (GI 50/125, GI 62.5/125, Large core: up to 800 μm)
Optical connector	Optical input: AQ9447 (□□) Connector adapter (option) required. Calibration output: AQ9441 (□□) Connector adapter (option) required. (□□) Connector type FC or SC
Built-in calibration light source	Wavelength reference source (For optical alignment and wavelength calibration)
Sweep time ^{*1,*6,*7}	NORM_AUTO: 0.5 s, NORMAL: 1 s, MID: 2 s, HIGH1: 5 s
Warm-up time	Minimum 1 hour (After warming up, optical alignment adjustment with built-in light source required.)

*1: Horizontal scale: Wavelength display mode.

*2: With 9.5/125 μm single mode fiber, after optical alignment with built-in reference light source, when the purge gas is not used.

*3: Vertical scale: Absolute power display mode, resolution setting: ≥ 0.2 nm

*4: With 9.5/125 μm single mode fiber (B1.1 type defined on IEC60793-2, PC polished, mode field diameter: 9.5 μm , NA: 0.104 to 0.107).

*5: Resolution setting: 0.05 nm

*6: Pulse light measurement mode: OFF.

*7: Span: ≤ 100 nm (excluding 570 to 580 nm and 900 to 1080 nm), number of sampling: 1001, average number: 1.

*8: High dynamic mode: SWITCH, fiber core size: SMALL

AQ6375E (2 μm)

The long wavelength model covering SWIR region

The AQ6375E covers not only telecommunication wavelengths, but also the SWIR region which is often used for environmental sensing and medical applications.

Features

Wavelength range: 1200 to 2400 nm*

*1000 to 2500 nm for AQ6375E-20

6 wavelength resolution settings: 0.05 to 2 nm*

Enables the user to choose the best value according to the device/system under test.

*4 res. setting for AQ6375E-01

Wide measurable level range: -70 to +20 dBm

Suitable to measure high power as well as low power sources to suit a wide variety of applications. Sensitivity: HIGH1-3* are only high dynamic mode.

*HIGH1-2 for AQ6375E-01

Wavelength accuracy: ± 0.05 nm

Easily maintained due to the built-in Calibration Function and wavelength reference source.

Close-in dynamic range: 55 dB

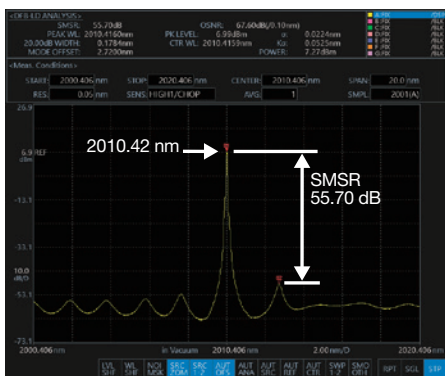

Measurement example of 2010 nm DFB-LD
(Res: 0.05 nm, Span: 20 nm)

Horizontal scale also in Wave Number (cm^{-1})

In addition to the commonly-used scales in wavelength (nm) and frequency (THz).

Purge feature

Built-in cut filter for high order diffracted light*

AQ6375E cuts the influence of unnecessary order diffracted light with the built-in optical filter, set automatically according to the measurement wavelength range.

*Except AQ6375E-01

DUT-oriented test apps (APP) simplifies the test process

Application (APP) mode transforms a versatile OSA into a machine dedicated to a device under test (DUT). APP mode provides a DUT-specific user interface that navigates the user from configuration settings to test result output without the user being aware of the wide variety of OSA settings.

Basic process of test applications



The AQ6375E comes pre-installed with several basic applications such as SC light source testing, DFB-LD testing, and FP-LD testing. In addition, the application can be downloaded from the Yokogawa website and added to the AQ6375E for use.

Large touchscreen LCD

The high-resolution, responsive multi-touch capacitive touchscreen makes device operation even simpler and more intuitive. You can change measurement conditions, perform analysis, change the optical spectrum view as if you were operating a tablet device. In the optical spectrum view, the waveform view can be zoomed or shifted by a simple tap and drag.

Enhanced function keys

The AQ6375E has greatly improved operability by adding frequently used keys to the hardware keys on the front panel, such as the sweep control (Auto/Single/Repeat/Stop), resolution setting, and sensitivity setting.

The function keys can also be popped up on the display for touch operation.



Specifications

Items	Specifications		
	Standard (AQ6375E-10)	Extended (AQ6375E-20)	Limited (AQ6375E-01)
Wavelength range ^{*1}	1200 to 2400 nm	1000 to 2500 nm	1200 to 2400 nm
Span ^{*1}	0.5 nm to 1200 nm (Full span), 0 nm	0.5 nm to 1500 nm (Full span), 0 nm	0.5 nm to 1200 nm (Full span), 0 nm
Wavelength accuracy ^{*1, *2, *5}	±0.05 nm (1520 to 1580 nm), ±0.1 nm (1580 to 1620 nm), ± 0.5 nm (Full range)		±0.1 nm (1520 to 1620 nm), ±0.5 nm (Full Range)
Wavelength repeatability ^{*1, *2}	±0.015 nm (1 min.)		
Wavelength resolution setting ^{*1, *2}	0.05, 0.1, 0.2, 0.5, 1 and 2 nm		0.1, 0.2, 0.5 and 1 nm
Minimum sampling resolution ^{*1}	0.002 nm		
Number of sampling	101 to 200001, AUTO		
Level sensitivity setting	NORM_HOLD, NORM_AUTO, NORMAL, MID, HIGH1, HIGH2 and HIGH3 (Only High dynamic mode (/CHOP) in HIGH1-3)		NORM_HOLD, NORM_AUTO, NORMAL, MID, HIGH1 and HIGH2 (Only High dynamic mode (/CHOP) in HIGH1-2)
Level sensitivity ^{*2, *3, *6}	-70 dBm (1800 to 2200 nm), -67 dBm (1500 to 1800 nm, 2200 to 2400 nm), -62 dBm (1300 to 1500 nm) (Sensitivity: HIGH3)		-65 dBm (1800 to 2200 nm), -62 dBm (1500 to 1800 nm, 2200 to 2400 nm), -57 dBm (1300 to 1500 nm) (Sensitivity: HIGH2)
Maximum input power ^{*2, *3}	+20 dBm (Per channel, Full wavelength range)		
Maximum safe input power ^{*2, *3}	+25 dBm (Total input power)		
Level accuracy ^{*2, *3, *4, *8}	±1.0 dB (1550 nm, Input level: -20 dBm, Sensitivity: MID, HIGH1-3)		±1.0 dB (1550 nm, Input level: -20 dBm, Sensitivity: MID, HIGH1-2)
Level linearity ^{*2, *3}	±0.05 dB (Input level: -30 to +10 dBm, Sensitivity: HIGH1-3)		±0.05 dB (Input level: -30 to +10 dBm, Sensitivity: HIGH1-2)
Polarization dependence ^{*2, *3, *8}	±0.1 dB (1550 nm)		
Dynamic range ^{*1, *2}	45 dB (Peak ±0.4 nm, Resolution: 0.05 nm), 55 dB (Peak ±0.8 nm, Resolution: 0.05 nm) (1523 nm, Sensitivity: HIGH1 to 3)		40 dB (Peak ±0.5 nm, Resolution: 0.1 nm) (1523 nm, Sensitivity: HIGH1-2)
Applicable fiber	SM (9.5/125), MM (GI 50/125, GI 62.5/125, Large core: up to 400 μm)		
Optical connector	Type FC (Optical input, Calibration output)		
Built-in calibration light source	Wavelength reference source (For optical alignment and wavelength calibration)		
Sweep time ^{*1, *6, *7}	NORM_AUTO: 0.5 sec, NORMAL: 1 sec, MID: 2 sec, HIGH1: 20 sec		
Warm-up time	Minimum 1 hour (After warming up, optical alignment adjustment with built-in light source required.)		

*1: Horizontal scale: Wavelength display mode.

*2: With 9.5/125 μm single mode fiber, after 2 hours of warm-up, after optical alignment with built-in reference light source, when the purge gas is not used.

*3: Vertical scale: Absolute power display mode, Resolution setting: ≥ 0.1 nm.

*4: With 9.5/125 μm single mode fiber (B1.1 type defined on IEC60793-2, PC polished, mode field).

*5: After wavelength calibration with built-in reference light source, Sampling resolution: ≤ 0.003 nm, Sensitivity: MID, HIGH1-3. (MID, HIGH1, 2 for Limited model)

*6: Pulse light measurement mode: OFF.

*7: Span: ≤ 100 nm, Number of sampling: 1001, Average number: 1.

*8: Temperature condition changes to 23 ±3°C at 0.1 nm resolution setting.

AQ6376E (3 μm)

The long wavelength model covering MWIR region

The AQ6376E covers the MWIR region which is often used for environmental sensing and medical applications.

Features

Wavelength range: 1500 to 3400 nm

5 wavelength resolution settings: 0.1 to 2 nm

Enables the user to choose the best value according to the device/system under test.

Wide measurable level range: -65 to +13 dBm

Suitable to measure high power as well as low power sources used in different fields of application. Sensitivity: HIGH1-3 are only high dynamic mode.

Wavelength accuracy: ± 0.5 nm

Easily maintained due to the built-in Calibration Function and wavelength reference source.

Close-in dynamic range: 55 dB

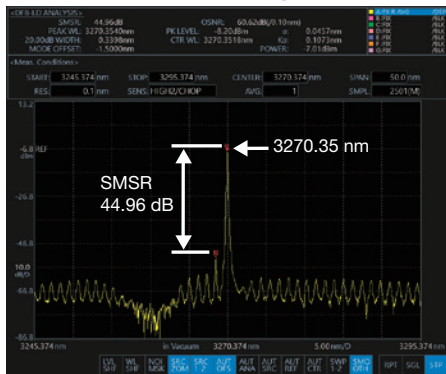

Measurement example of 3270 nm DFB-LD
(Res: 0.1 nm, Span: 50 nm)

Horizontal scale also in Wave Number (cm^{-1})

In addition to the commonly-used scales in wavelength (nm) and frequency (THz).

Purge feature

Built-in cut filter for high order diffracted light

The AQ6376E automatically sets an internal optical filter according to the measurement wavelength range. The filter drastically reduces the influence of high order diffracted light on the measurement.

Specifications

Items	Specifications
Wavelength range ^{*1}	1500 to 3400 nm
Span ^{*1}	0.5 nm to 1900 nm (Full span), 0 nm
Wavelength accuracy ^{*1, *2, *5}	± 0.5 nm (Full range)
Wavelength repeatability ^{*1, *2}	± 0.015 nm (1 min.)
Wavelength resolution setting ^{*1, *2}	0.1, 0.2, 0.5, 1 and 2 nm
Minimum sampling resolution ^{*1}	0.003 nm
Number of sampling	101 to 200001, AUTO
Level sensitivity setting	NORM_HOLD, NORM_AUTO, NORMAL, MID, HIGH1, HIGH2 and HIGH3 (Only High dynamic mode (/CHOP) in HIGH1-3)
Level sensitivity ^{*2, *3, *4, *6}	-65 dBm (1500 to 2200 nm), -55 dBm (2200 to 3200 nm), -50 dBm (3200 to 3400 nm) (Sensitivity: HIGH3)
Maximum input power ^{*2, *3}	+13 dBm (Per channel, Full wavelength range)
Maximum safe input power ^{*2, *3}	+20 dBm (Total input power)
Level accuracy ^{*2, *3, *4, *8}	± 1.0 dB (1550 nm, input level: -20 dBm, Sensitivity: MID, HIGH1-3)
Level linearity ^{*2, *3}	± 0.2 dB (Input level: -30 to +10 dBm, Sensitivity: HIGH1-3)
Dynamic range ^{*1, *2}	40 dB (Peak ± 1 nm, Resolution: 0.1 nm), 55 dB (Peak ± 2 nm, Resolution: 0.1 nm) (1523 nm, Sensitivity: HIGH1-3)
Applicable fiber	SM (9.5/125), MM (GI 50/125, GI 62.5/125, Large core: up to 400 μm)
Optical connector	Type FC (Optical input, Calibration output)
Built-in calibration light source	Wavelength reference source (For optical alignment and wavelength calibration)
Sweep time ^{*1, *6, *7}	NORM_AUTO: 0.5 sec, NORMAL: 1 sec, MID: 2 sec, HIGH1: 20 sec
Warm-up time	Minimum 1 hour (After warming up, optical alignment adjustment with built-in light source required.)

*1: Horizontal scale: Wavelength display mode.

*2: With 9.5/125 μm single mode fiber, after 2 hours of warm-up, after optical alignment with built-in reference light source, when the purge gas is not used.

*3: Vertical scale: Absolute power display mode, Resolution setting: ≥ 0.2 nm.

*4: With 9.5/125 μm single mode fiber (B1.1 type defined on IEC60793-2, PC polished, mode field).

*5: After wavelength calibration with built-in reference light source, Sampling resolution: ≤ 0.003 nm, Sensitivity: MID, HIGH1-3.

*6: Pulse light measurement mode: OFF.

*7: Span: ≤ 100 nm, Number of sampling: 1001, Average number: 1.

*8: Temperature condition changes to $23 \pm 3^\circ\text{C}$ at 0.1 nm resolution setting.

AQ6377 (5 μm)

The long wavelength model covering MWIR region

The AQ6377 covers the MWIR region which is often used for environmental sensing and medical applications.

Features

Wavelength range: 1900 to 5500 nm

5 wavelength resolution settings: 0.2 to 5 nm

Enables the user to choose the best value according to the device/system under test.

Wide measurable level range: -60 to +13 dBm

Suitable to measure high power as well as low power sources used in different fields of application. Sensitivity: HIGH1-3 are only high dynamic mode.

Wavelength accuracy: ± 0.5 nm

Easily maintained due to the built-in Calibration Function and wavelength reference source.

Close-in dynamic range: 50 dB

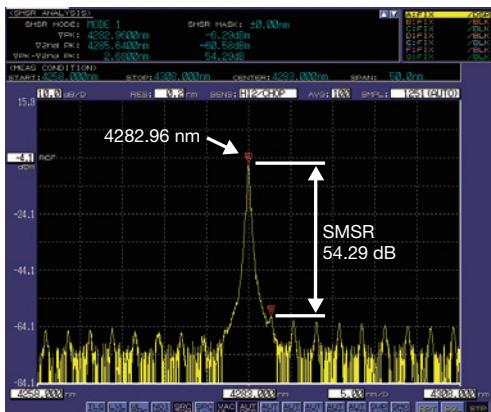

Measurement example of 4.3 μm DFB laser
(Res: 0.2 nm, Span: 50 nm)

Horizontal scale also in Wave Number (cm^{-1})

In addition to the commonly-used scales in wavelength (nm) and frequency (THz).

Purge feature

Built-in cut filter for high order diffracted light

The AQ6377 automatically sets an internal optical filter according to the measurement wavelength range. The filter drastically reduces the influence of high order diffracted light on the measurement.

Specifications

Items	Specifications
Wavelength range ^{*1}	1900 to 5500 nm
Span ^{*1}	1.0 nm to 3600 nm (Full span), 0 nm
Wavelength accuracy ^{*1,*2}	± 0.5 nm (Full range)
Wavelength resolution setting ^{*1,*2}	0.2, 0.5, 1, 2 and 5 nm
Minimum sampling resolution ^{*1}	0.010 nm
Number of sampling	101 to 50001, AUTO
Level sensitivity setting	NORM_HOLD, NORM_AUTO, NORMAL, MID, HIGH1, HIGH2 and HIGH3 (Only High dynamic mode (/CHOP) in HIGH1-3)
Level sensitivity ^{*3,*5,*6}	-40 dBm (1900 to 2200 nm), -50 dBm (2200 to 2900 nm), -60 dBm (2900 to 4500 nm) (Sensitivity: HIGH3)
Maximum input power ^{*3,*5,*6}	+13 dBm (Per channel, full wavelength range)
Maximum safe input power ^{*3,*5,*6}	+20 dBm (Total input power)
Level accuracy ^{*3,*4,*5,*6}	± 2.0 dB (2000 nm, input level: -10 dBm, Sensitivity: HIGH1-3, single mode fiber)
Dynamic range ^{*1,*2,*3}	50 dB (Peak ± 5 nm, Resolution: 0.2 nm, Sensitivity: HIGH1-3)
Applicable fiber	SM, MM (Large core: up to 400 μm)
Optical connector	FC type (Optical input and Calibration output)
Built-in calibration light source	Wavelength reference source (For optical alignment and wavelength calibration)
Sweep time ^{*1,*6,*7}	NORM_AUTO: 0.5 s, NORMAL: 1 s, MID: 2 s, HIGH1: 20 s
Warm-up time	Minimum 1 hour (After warming up, optical alignment adjustment with built-in light source required.)

*1: Horizontal scale: Wavelength display mode.

*2: Single mode fiber, after 2 hours of warm-up, after optical alignment with built-in reference light source, when the purge gas is not used.

*3: Typical.

*4: Difference from Yokogawa's original standard device, with single mode fiber for 2 μm range.

*5: Vertical scale: Absolute power display mode, Resolution setting: ≥ 0.5 nm.

*6: Pulse light measurement mode: OFF.

*7: Span: ≤ 100 nm (excluding 2200 to 2220 nm and 3900 to 3940 nm), number of sampling: 1001, average number: 1.

General Functions

Items	Functions	
Measurement	Measurement mode	CW light, Pulsed light, External trigger, Gate sampling, Air/vacuum wavelength
	Sweep mode	Repeat, Single, AUTO (Self-configuration), Sweep between line markers, Data logging ⁷²
	Condition settings	Center wavelength, Span, Number of sampling, Wavelength resolution, Sensitivity, High dynamic mode, Number of averaging (1 to 999 times), Double speed mode, Smoothing, APC level correction ⁷¹ , HCDR mode ⁷¹ , Large core size fiber mode (AQ6373B/AQ6374 only)
	Others	Sweep status output, Analog output
Display	Vertical scale	Level scale (0.1 to 10 dB/div. and linear), Level subscale (0.1 to 10 dB/div. and linear), Reference level, Divisions (8, 10 or 12 ⁷²), power spectral density (dB/nm), dB/km ⁷² , %, Noise mask
	Horizontal scale	Wavelength (nm), Frequency (THz), Wave number (cm ⁻¹) (AQ6375E, AQ6376E and AQ6377), Trace zoom in/out
	Display mode & items	Normal display, Split display ⁷² , Data table, Label, Template ⁷² , Measurement conditions
Trace	Trace functions	7 independent traces, Maximum/Minimum hold, Calculation between traces, Normalizing, Curve fit, Peak curve fit, Marker curve fit, Roll averaging (2 to 100 times)
	Others	Trace copy/clear, Write/Fix setting, Display/Blank setting
Marker & Search	Marker	Delta markers (Max. 1024), Vertical/horizontal line markers, Advanced markers
	Search	Peak, Bottom, Auto-search (ON/OFF), Search between horizontal line markers, Search zoomed area
Data analysis	Analysis functions	Spectral width (threshold, envelope, RMS, peak-RMS, notch), WDM (OSNR) analysis, EDFA-NF analysis (excl. AQ6373B), Filter peak/bottom analysis, WDM filter peak/bottom analysis (excl. AQ6373B), DFB-LD/ FP-LD/ LED analysis, SMSR analysis, Power analysis, iTLA analysis ⁷¹ , PMD analysis ⁷² , Color analysis (AQ6373B/AQ6374 only), Pass/Fail analysis with template ⁷²
	Others	Auto-analysis (ON/OFF), Analysis between horizontal line markers, Analysis in zoomed area
Automated measurement	Program function ⁷²	64 programs, 200 steps per program
	Application ⁷³	SC test, WDM test, DFB-LD test, LED test, FP-LD test, Fiber inspection, Application management (add/delete), Program function ⁷¹
Other functions	Optical alignment	Auto-optical alignment with built-in light source or an external reference source.
	Wavelength calibration	Auto-wavelength calibration with built-in wavelength reference source (excl. AQ6373B) or an external wavelength reference source. Note. AQ6373B requires an external reference source for wavelength calibration.
	Resolution calibration ⁷¹	Resolution calibration with an external reference source.

*1: AQ6370E only

*2: AQ6373B, AQ6374 and AQ6377

*3: AQ6370E, AQ6375E and AQ6376E

General Specifications

Items	Specifications	
Electrical interface	GP-IB, RS-232 ⁷⁵ , Ethernet, USB, VGA output, Analog output port, Trigger input port, Trigger output port	
Remote control ⁷¹	GP-IB, RS-232 ⁷⁵ , Ethernet (TCP/IP), AQ6317 series compatible commands (IEEE488.1) and IEEE488.2	
Purge gas input/output terminals ⁷²	Outer diameter 1/4 nylon tube (inch size)	
Data storage	Internal storage: 512 MBytes, Internal memory ⁷⁵ : 64 Traces, 64 programs, 3 template lines External storage: USB storage (memory/HDD), FAT32 format File types: CSV (text), Binary, BMP, TIFF ⁷⁵ , PNG ⁷⁵ , JPEG ⁷⁵	
Display ⁷³	10.4-inch color LCD (Resolution: 800 × 600) ⁷⁵ 10.4-inch color LCD (capacitive touchscreen, resolution: 1024 × 768 pixels) ⁷⁵	
Dimensions	426 (W) × 221 (H) × 459 (D) mm (Excluding protector and handle)	
Mass	AQ6370E/AQ6373B/AQ6374: 19 kg, AQ6375E/AQ6376E: 22 kg, AQ6377: 23 kg	
Power requirements	100 to 240 V AC, 50/60 Hz, approx. 100 VA	
Environmental conditions	Performance guarantee temperature: +18 to +28°C (Except AQ6377), +18 to +26°C (AQ6377), Operating temperature: +5 to +35°C (Except AQ6377), +5 to +33°C (AQ6377) Storage temperature: -10 to +50°C, Humidity: 20 to 80%RH (no condensation)	
Safety standards	EN 61010-1	
EMC	Laser ⁷⁴	EN 60825-1: 2014+A11: 2021, IEC 60825-1: 2007, GB 7247. 1-2012 Class 1
	Emission	EN 61326-1 Class A ⁷⁵ , EN 55011 Class A Group 1 ⁷⁵ , EN 61000-3-2, EN 61000-3-3, EN 61326-1 Class A Group 1 ⁷⁵ , RCM EN 55011 Class A Group 1 ⁷⁵ , RCM EN 61326-1 Class A Group 1 ⁷⁵ , Korea Electromagnetic Conformity Standard
	Immunity	EN 61326-1 Table 2
Recommended calibration period	1 year	

*1: Some AQ6317 series commands may not be compatible due to changes in specifications or functions.

*2: AQ6374, AQ6375E, AQ6376E and AQ6377

*3: Liquid crystal display may include a few defective pixels (within 0.002% with respect to the total number of pixels including RGB). There may be a few pixels on the liquid crystal display that do not emit all the time or remains ON all the time. These are not malfunctions.

*4: With built-in calibration light source

*5: AQ6373B, AQ6374 and AQ6377

*6: AQ6370E, AQ6375E and AQ6376E

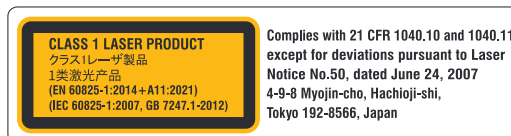

Dimensions

AQ6370E, AQ6375E, AQ6376E

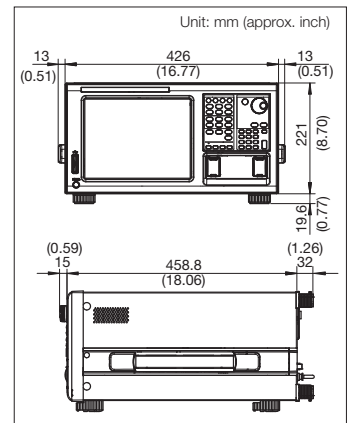

AQ6373B, AQ6374, AQ6377

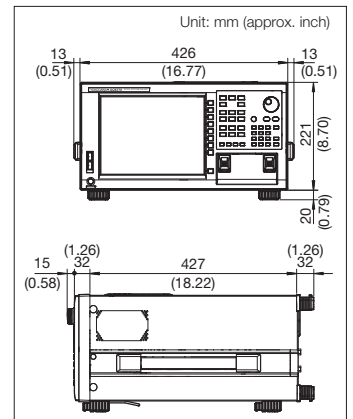

Accessories and related products

Optical Connector Adapters

(AQ6370E and AQ6374)

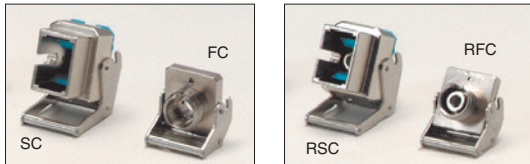

For optical input port
AQ9447 Connector Adapter
/SC, /FC

For calibration output port
AQ9441 Connector Adapter
/RSC, /RFC

NA Conversion Fiber (optional)

By connecting a GI 50 or GI 62.5 optical fiber with a relatively large NA to the NA Conversion Fiber, the NA Conversion Fiber reduces the loss that occurs at the input and improves the measurement dynamic range during passive device measurements and the stability of optical level measurements during active device measurements.

Note

- The stability of measurement results depend on the operating environment.
- If the wavelength resolution of the optical spectrum analyzer is set smaller than 0.05 nm when using the NA converted fiber, the measurement results may become unstable.
Setting the wavelength resolution to a larger wavelength resolution, such as 0.1 nm or 0.2 nm, gradually improves the stability of the measurement results.
- When using GI62.5 and GI50 multimode optical fibers coupled to NA converted fibers, it is recommended to set the wavelength resolution of the optical spectrum analyzer to 0.2 nm or higher.

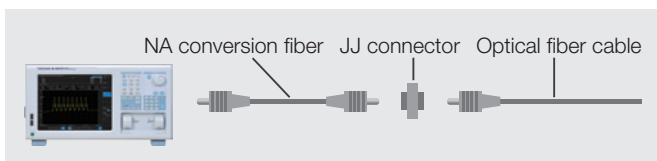

Accessories (optional)

Model	Suffix	Descriptions
735371		AQ6370 Viewer (For the AQ6370 series, AQ6360 and AQ6380)
AQ9447		AQ9447 Connector Adapter
Connector type	-FC	FC type
	-SC	SC type
AQ9441		AQ9441 Connector Adapter
Connector type	-FC	FC type
	-SC	SC type
735384	-A001	NA conversion fiber (for GI 50 optical fibers)
	-A002	NA conversion fiber (for GI 62.5 optical fibers)
751535	-E5	Rack mount kit (For an EIA-compliant Single-housing Rack)
	-J5	Rack mount kit (For an JIS-compliant Single-housing Rack)

AQ6150 Series Optical Wavelength Meters

The AQ6150B and AQ6151B Optical Wavelength Meters are fast, accurate and cost-effective instruments for carrying out measurements in the telecommunications wavelength range from 900 to 1700 nm.



AQ2200 Series

Multi-Application Test System (MATS)

The AQ2200 MATS is the ideal system for measuring and evaluating a wide range of optical devices and optical transmission systems.

A variety of measurement modules are available, including: high-stability light sources, high-speed optical sensors, high-resolution variable optical attenuators, low insertion loss optical switches, and optical transceiver interfaces. These modules can be installed in any combination on a single platform, providing an ideal measurement system for a variety of applications.



Model and Suffix code

AQ6370E

Model	Suffix	Descriptions	
AQ6370E		AQ6370E Optical Spectrum Analyzer	
Spec code	-10	Standard model	
	-20	High performance mode	
Built-in light source	-L0	Without light source	
	-L1	Wavelength reference source	
Power cord	-D	UL/CSA standard and PSE compliant, 125 V	
	-F	VDE/Korean standard, 250 V	
	-R	Australian standard, 250 V	
	-H	Chinese standard, 250 V	
	-Q	British standard, 250 V	
	-N	Brazilian standard, 250 V	
	-T	Taiwanese standard, 125 V	
	-B	Indian standard, 250 V	
	-U	IEC Plug Type B, 250 V	
	Factory installed options	/FC	AQ9447 (FC) Connector Adapter
/SC		AQ9447 (SC) Connector Adapter	
/RFC		AQ9441 (FC) Connector Adapter	For Calibration Output
/RSC		AQ9441 (SC) Connector Adapter	

AQ6373B

Model	Suffix	Descriptions	
AQ6373B		AQ6373B Optical Spectrum Analyzer	
Spec code	-12	Standard model	
Built-in light source	-L1	Optical alignment source	
Power cord	-D	UL/CSA standard and PSE compliant, 125 V	
	-F	VDE/Korean standard, 250 V	
	-R	Australian standard, 250 V	
	-H	Chinese standard, 250 V	
	-Q	British standard, 250 V	
	-N	Brazilian standard, 250 V	
	-T	Taiwanese standard, 125 V	
	-B	Indian standard, 250 V	
	-U	IEC Plug Type B, 250 V	

AQ6374

Model	Suffix	Descriptions	
AQ6374		AQ6374 Optical Spectrum Analyzer	
Spec code	-10	Standard model	
Built-in light source	-L1	Wavelength reference source	
Power cord	-D	UL/CSA standard and PSE compliant, 125 V	
	-F	VDE/Korean standard, 250 V	
	-R	Australian standard, 250 V	
	-H	Chinese standard, 250 V	
	-Q	British standard, 250 V	
	-N	Brazilian standard, 250 V	
	-T	Taiwanese standard, 125 V	
	-B	Indian standard, 250 V	
	-U	IEC Plug Type B, 250 V	
	Factory installed options	/FC	AQ9447(FC) Connector Adapter
/SC		AQ9447(SC) Connector Adapter	
/RFC		AQ9441(FC) Connector Adapter	For Calibration Output
/RSC		AQ9441(SC) Connector Adapter	

■ Microsoft, MS, and Windows are registered trademarks or trademarks of Microsoft Corporation in the US and other countries. LabVIEW is a U.S. registered trademark of National Instruments.
Other company names and product names appearing in this document are the registered trademarks of their respective companies.

AQ6375E

Model	Suffix	Descriptions	
AQ6375E		AQ6375E Optical Spectrum Analyzer	
Spec code	-10	Standard model	
	-20	Extended model	
	-01	Limited model	
Built-in light source	-L1	Wavelength reference source	
Power cord	-D	UL/CSA standard and PSE compliant, 125 V	
	-F	VDE/Korean standard, 250 V	
	-R	Australian standard, 250 V	
	-H	Chinese standard, 250 V	
	-Q	British standard, 250 V	
	-N	Brazilian standard, 250 V	
	-T	Taiwanese standard, 125 V	
	-B	Indian standard, 250 V	
	-U	IEC Plug Type B, 250 V	

AQ6376E

Model	Suffix	Descriptions	
AQ6376E		AQ6376E Optical Spectrum Analyzer	
Spec code	-10	Standard model	
Built-in light source	-L1	Wavelength reference source	
Power cord	-D	UL/CSA standard and PSE compliant, 125 V	
	-F	VDE/Korean standard, 250 V	
	-R	Australian standard, 250 V	
	-H	Chinese standard, 250 V	
	-Q	British standard, 250 V	
	-N	Brazilian standard, 250 V	
	-T	Taiwanese standard, 125 V	
	-B	Indian standard, 250 V	
	-U	IEC Plug Type B, 250 V	

AQ6377

Model	Suffix	Descriptions	
AQ6377		AQ6377 Optical Spectrum Analyzer	
Spec code	-10	Standard model	
Built-in light source	-L1	Wavelength reference source	
Power cord	-D	UL/CSA standard and PSE compliant, 125 V	
	-F	VDE/Korean standard, 250 V	
	-R	Australian standard, 250 V	
	-H	Chinese standard, 250 V	
	-Q	British standard, 250 V	
	-N	Brazilian standard, 250 V	
	-T	Taiwanese standard, 125 V	
	-B	Indian standard, 250 V	
	-U	IEC Plug Type B, 250 V	

NOTICE

● Before operating the product, read the user's manual thoroughly for proper and safe operation.

■ Any company's names and product names mentioned in this document are trade names, trademarks or registered trademarks of their respective companies.

Yokogawa's Approach to Preserving the Global Environment

- Yokogawa's electrical products are developed and produced in facilities that have received ISO14001 approval.
- In order to protect the global environment, Yokogawa's electrical products are designed in accordance with Yokogawa's Environmentally Friendly Product Design Guidelines and Product Design Assessment Criteria.

This is a Class A instrument based on Emission standards EN61326-1 and EN55011, and is designed for an industrial environment.
Operation of this equipment in a residential area may cause radio interference, in which case users will be responsible for any interference which they cause.



YOKOGAWA TEST & MEASUREMENT CORPORATION

Global Sales Dept. /E-mail: tm@cs.jp.yokogawa.com

- YOKOGAWA CORPORATION OF AMERICA
- YOKOGAWA EUROPE B.V.
- YOKOGAWA TEST & MEASUREMENT (SHANGHAI) CO., LTD.
- YOKOGAWA ELECTRIC KOREA CO., LTD.
- YOKOGAWA ENGINEERING ASIA PTE. LTD.
- YOKOGAWA INDIA LTD.
- YOKOGAWA ELECTRIC CIS LTD.
- YOKOGAWA AMERICA DO SUL LTDA.
- YOKOGAWA MIDDLE EAST & AFRICA B.S.C(c)

- <https://tmi.yokogawa.com/us/>
- <https://tmi.yokogawa.com/eu/>
- <https://tmi.yokogawa.com/cn/>
- <https://tmi.yokogawa.com/kr/>
- <https://tmi.yokogawa.com/sg/>
- <https://tmi.yokogawa.com/in/>
- <https://tmi.yokogawa.com/ru/>
- <https://tmi.yokogawa.com/br/>
- <https://tmi.yokogawa.com/bh/>

<https://tmi.yokogawa.com/>

YMI-N-MI-M-E03

The contents are as of June 2023. Subject to change without notice.
Copyright © 2014, Yokogawa Test & Measurement Corporation
[Ed: 13/b] Printed in Japan, 306(KP)