

TIGER FAMILY



FI-B101D50E & FI-B101D50T

Programmable Meter Controllers

Tiger 320 Series PMCs

**101 Segment Bargraph, 5 Digit 0.31" LEDs
in a 9/64 DIN Case**

A powerful, intelligent, 5-digit, 101-segment Programmable Meter Controller (PMC) with modular outputs, input signal conditioning and advanced software features for monitoring, measurement, control and communication applications.

General Features

- The Tiger 320 Operating System supports an easy to use PC based Configuration Utility Program (which can be downloaded FREE from the Texmate website) and programming from front panel buttons.
- The T Version supports custom macro programs that can be easily produced with the Tiger 320 Macro Development System (available FREE on the Texmate website). The Development System enables programs to be written in BASIC, which can utilize any combination of the hundreds of functions and thousands of registers embedded in the Tiger 320 Operating System.
- Red 7-segment, 0.31" high LEDs with full support for seven segment alphanumeric text.
- Brightness control of LED display from front panel buttons.
- 101 segment red, green or tricolor bargraph that can display the signal from any of four channels or the result of a processed input signal.
- Modular construction with more than 120 interchangeable input signal conditioners.
- Up to 4 input channels with cross channel math for multi-channel processing.
- For applications where sensor excitation is required, modules are provided with 5V, 10V or 24 V DC voltage outputs.
- On demand tare, calibration and compensation can be initiated by the front panel program button.
- Autozero maintenance for super stable zero reading is provided for use in weighing applications.
- Programmable input averaging and smart digital filtering for quick response to input signal changes.
- Display text editing. Customize display text for OEM applications.
- Scrolling display text messaging on T meters with macros.
- Auto-sensing high voltage or optional low voltage AC / DC power supply.
- Serial output options include RS-232, RS-485, ModBus or direct meter-to-meter communications.
- Single or dual 16-bit Isolated Analog Outputs. Programmable 0~4 to 20mA or 0 to 10V for retransmission, 4-20mA loops to drive valve actuators, remote controllers & displays, multi-loop feedback and PID output. Scalable from 1 count to full scale.
- Dual independent totalizers to integrate input signals.
- 6 super smart, independently programmable setpoints with 8 selectable functions, including latching, deviation, hysteresis, register resetting, tracking and dual PID. Plus 7 programmable timer modes on all 6 setpoints.
- Setpoint tracking, setpoint latching and manual relay reset.
- Setpoints activated from any input, any register in the meter or from any digital input.
- Up to 4 independent programmable electromechanical and solid state relays.
- Internal program safety lockout switch to prevent tampering.
- Peak & valley (max & min) with front panel recall and reset.
- Real time clock with 15 year Lithium battery backup.
- Data logging within the meter (up to 4000 samples with date/time stamp).
- Optional NEMA-4 front cover.
- UL Listed

Input Module Compatibility

TIGER FAMILY: More than 120 different Plug-in I-Series Input Signal Conditioners are approved for the Tiger Family of meters.



See *I-Series Input Signal Conditioning Modules Guide (Z87)* for an up-to-date list.

Table of Contents

| | | | | | |
|--|-------|---|-------|---------------------------|-------|
| General Features | 1 | Programming Procedures. | 16-34 | Index | 48-49 |
| Specifications. | 2-3 | Setpoint Programming Mode | 35-41 | Case Dimensions | 50 |
| Block Diagram of Tiger 320 Structure | 4 | Registers | 42 | | |
| Controls & Indicators. | 5-6 | Functional Diagram. | 43 | | |
| Front Panel Configuration & Setup. | 7 | Connector Pinouts. | 43 | | |
| Front Panel Programming Codes. | 8-9 | Carrier Board Output Pins | 44 | | |
| Initial Setup Procedures | 10-11 | Relay Options | 44 | | |
| Display Brightness. | 11 | Component Layout & Ext. Devices | 45-46 | | |
| Calibration Modes | 12-15 | Installation Guidelines. | 47 | | |

Display

Digital Display: 7-segment, 0.31" (8 mm) LEDs.

Display Color: Red

Digital Display Range: -19999 to 99999

Update Rate: 3 to 10 times per second

Bargraph Display: 101-segment bargraph.

Bargraph Color: Red (std). Green or Tricolor (optional).

Display Dimming: 8 brightness levels. Front Panel selectable

Scrolling Display Text Messaging: Full alphanumeric, 7-segment text characters supported on T Version with macros.

Polarity: Assumed positive. Displays - negative

Decimal Point: Front panel, user selectable to five positions.

Overrange Indication: 

Underrange Indication: 

Front Panel Controls: PROGRAM, UP and DOWN.

Operating System (Tiger 320)

Processor: 32 bit with floating point maths (18.4 MHz).

Flash Memory: 64k, 4k for use by custom macros.

RAM: 1.25k and FeRAM 4k.

EEPROM: E Version 4k standard, T Version 32k standard. Memory upgrades available to 32k for LIN Tables and 1MB for Data Logging and custom macros.

Registers: 6144 registers comprised of 8, 16 or 32 bit signed, unsigned or floating point registers, implemented in a combination of RAM, FeRAM, Flash and EEPROM.

Internal communication BUS: 32 bit I²C BUS

Real Time Clock (option): Year:Month:Date:Hour:Minute:Second with 15 yr Lithium battery backup.

Configuration: Supports Front Panel Programming Codes and a PC-based Configuration Utility Program, which may be downloaded free from our website. T Version also supports custom macros.

Development System for Custom Macros

The Tiger 320 Macro Development System, which may be downloaded free from our website, can be used to create powerful macro software that allows Tiger 320 T Versions to be easily customized to suit any proprietary OEM application.

Installed Application Software Includes

Counter Functions: Two built-in counters. UP counters, DOWN counters, UP/DOWN counters and high speed quadrature counters.

Data Logging: Logging with a date/time stamp, initiated at timed intervals, by activation of a setpoint, or manually. Data stored in internal 1MB EEPROM or in a removable 4 to 128M Flash Card Memory Module. Endless loop recording is supported.

Input Compensation: Provides compensation to the primary input channel (CH1) via channels 2, 3 or 4.

Linearization: 4 selectable 32 point or one 125 point flexible linearization tables are provided.

Logic I/O: 28 Macro programmable I/O ports supported.

Manual Loader: Front panel adjustable, 4 to 20mA or 0 to 10V isolated analog output.

Math Functions: Cross channel math functions to calculate the sum, difference, ratio or the product of two inputs.

On Demand Functions: Tare, compensation and calibration.

Peak and Valley: The meter can retain peak and valley (min/max) information and recall this on the front panel.

Remote Setpoint Input: Remote setpoint input via channel 2.

Serial Output Protocols: Selectable communication modes include ASCII, Modbus (RTU), Master Mode (for meter to meter communication) and an Epson compatible printer driver.

Setpoint Functions: Six super smart setpoints with fully configurable hysteresis, on and off delays, one shot, pulse and repeat timers, latching, dual PID, setpoint tracking, resetting of registers, initiating of logging and printing.

Signal Conditioning Functions: Averaging, smart filter, rounding, square root, auto zero maintenance.

Timer: Timer functions supported in either time-up, time-down, or real-time clock modes.

Totalizer: Two totalizers for running total and batch totals of a process signal that can be accumulated over time.

Inputs

Inputs Available: More than 120 single, dual, triple and quad input signal conditioners available covering all types of analog, digital and mixed input signals.

Accuracy: Tiger 320 PMCs enable the user to establish any degree of system accuracy required. Built-in compensation and linearization functions enable system accuracies of the order of $\pm 0.0001\%$ of reading for analog inputs. Stop -Start time resolution from ± 1 sec to ± 0.7 nsec. Digital input and pulse counts ± 1 count.

A/D Convertors: A Dual Slope, bipolar 17 bit A/D is provided as standard on the main board. SMART modules can have 24 bit or 16 bit Delta-Sigma A/D convertors that utilize the internal I²C BUS.

Temperature Coefficient: Typically 30ppm/ $^{\circ}$ C. Compensation can be utilized to achieve system temperature coefficients of 1ppm.

Warm Up Time: Up to 10 minutes, depending on input module.

Conversion Rate: Typically 10 samples per second. However, SMART input modules are available that can convert at 60, 240, 480 or 960 samples per second.

Control Output Rate: Can be selected for 100msec or 10msec. Some SMART modules have SSR outputs that react within 1.2msec.

Excitation Voltage: Depends on input module selected. Typically, 5V, 10V or 24VDC is provided.

Outputs

(See pages 44-46 for pinouts and details of modular construction)

Carrier Board: Provides three different serial outputs or no serial output and supports single or dual analog outputs.

Standard Carrier Board: Is available without a serial output, or with either an isolated RS-232 or an isolated RS-485 (RJ-6 socket).

Two Isolated Analog Output Options: Mounted on any carrier board.

1. Single Analog Output: Fully scalable from 4 to 20mA or 0 to 20mA (or reverse) and selectable for 0 to 10VDC (or reverse).

2. Dual Analog Output: Fully scalable from 0 to 10VDC (or reverse).

Outputs continued

Analog Output Specifications: Accuracy: 0.02% FS. Resolution: 16-bit Delta-Sigma D/A provides 0.4 μ A on current scaling, 250 μ V on voltage scaling. Compliance: 500 Ω maximum for current output. 500 Ω minimum for voltage output. Update Rate: Typical 7 per second. Step Response: Typical 6msec to a display change. Scalable: From 1 count to full scale.

Power Supplies

Auto sensing AC/DC (DC to 400Hz) hi volts std, low volts optional.

PS1 (standard): 95-300VDC / 85-265VAC, 50-400Hz, 3.5W nominal.

PS2 (optional): 10-72VDC / 14-48VAC, 50-400Hz, 3.5W nominal.

Environmental (See Rear page for IP-65 & NEMA-4 options)

Operating Temperature: 0 to 50 $^{\circ}$ C (32 $^{\circ}$ F to 122 $^{\circ}$ F).

Storage Temperature: -20 $^{\circ}$ C to 70 $^{\circ}$ C (-4 $^{\circ}$ F to 158 $^{\circ}$ F).

Relative Humidity: 95% (non-condensing) at 40 $^{\circ}$ C (104 $^{\circ}$ F).

Mechanical (See Rear page for more details)

Case Dimensions: 9/64 DIN, 144x36mm (5.69" x 1.42")

Case Material: 94V-0 UL rated self-extinguishing polycarbonate.

Weight: 11.5 oz (0.79 lbs), 14 oz (0.96 lbs) when packed.

Certifications and Listings

CE: As per EN-61000-3/4/6 and EN-61010-1.

UL: E469078

Block Diagram of the Tiger 320 Series Software and Hardware Structure

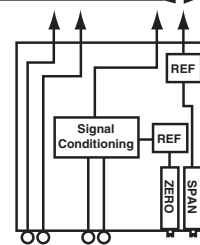
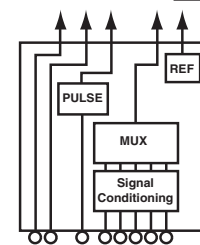
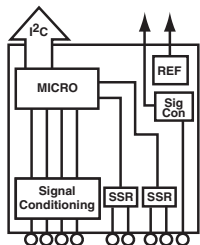
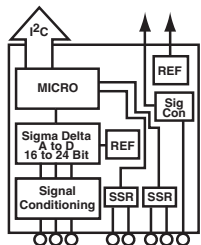
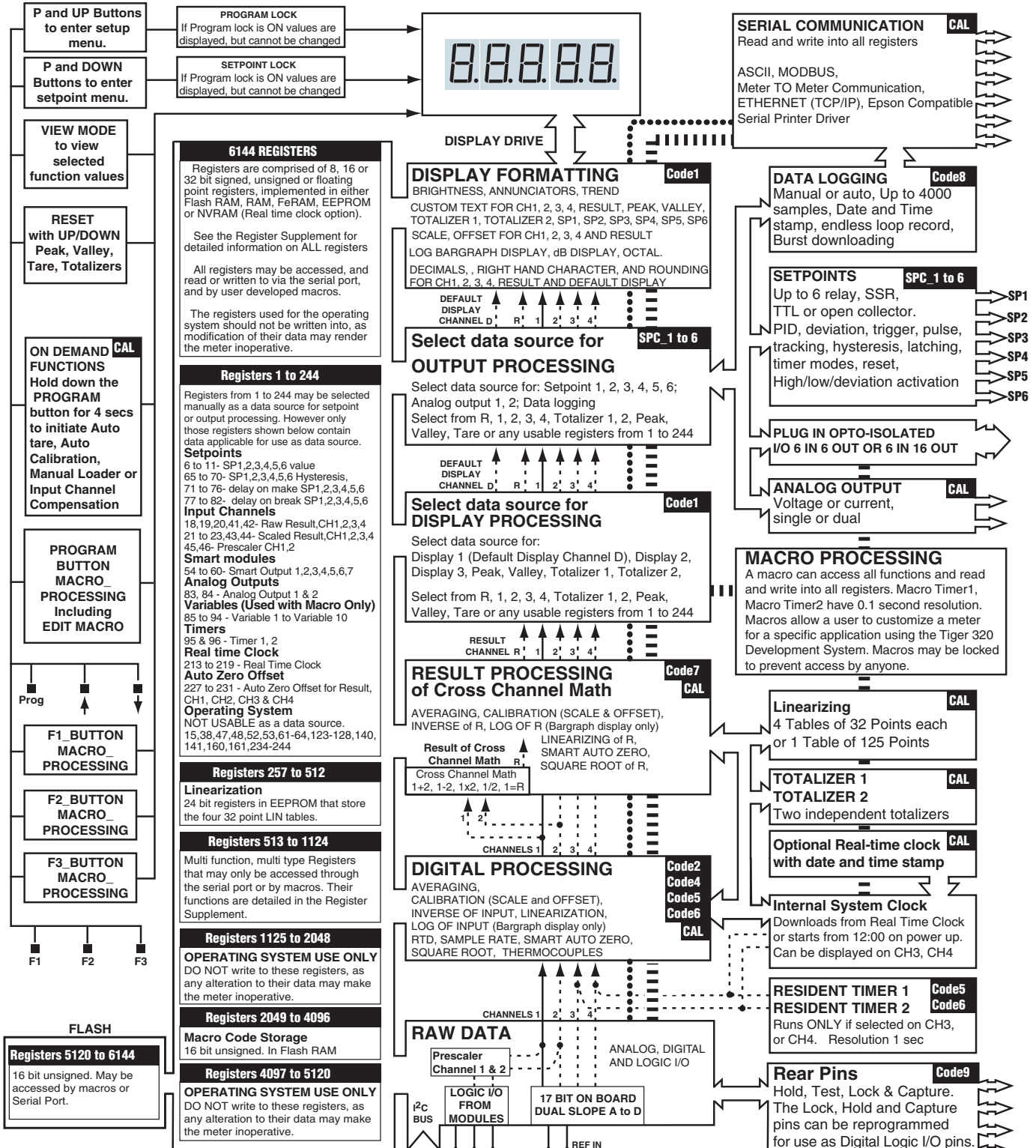

Front Panel Controls and Indicators

Program Button

While programming, pressing the **P** button saves the current programming settings and moves to the next programming step.

You can move through the programming codes using the program button. The codes you pass are not affected, unless you stop and make changes using the **↑** or **↓** buttons.

Pressing the **P** and **↑** button at the same time initiates the **main programming mode**. To save a new configuration setting and return to the operational display, press the **P** button

once and then press the **P** and **↑** button at the same time.

Pressing the **P** and **↓** button at the same time initiates the **setpoint programming mode**. To save a new configuration setting and return to the operational display, press the **P** button once and then press the **P** and **↓** button at the same time.

See *Display with Faceplate and Bezel diagram*.

Up Button

When setting a displayed parameter during programming, press the **↑** button to increase the value of the displayed parameter.

When in the operational display, pressing the **↑** button initiates a viewing mode that allows you to view the readings on **channels 1 and 3, setpoints 1, 3, and 5, peak, and total 1**. Once into the viewing routine, pressing the **↑** button moves through each displayed parameter.

See *Display with Faceplate and Bezel diagram*.

Down Button

When setting a displayed parameter during programming, press the **↓** button to decrease the value of the displayed parameter.

When in the operational display, pressing the **↓** button initiates a viewing mode that allows you to view the readings on **channels 2 and 4, setpoints 2, 4, and 6, valley, and total 2**. Once into the viewing routine, pressing the **↓** button moves through each displayed parameter.

See *Display with Faceplate and Bezel diagram*.

Annunciator LEDs

The annunciator LEDs can be programmed to indicate the alarm status.

Setpoint 1 can be configured to indicate the **rising** signal trend. Setpoint 2 can be configured to indicate the **falling** signal trend. They are labeled from left to right: SP1, SP2, SP3, SP4, SP5, SP6.

See *Display with Faceplate and Bezel diagram*.

LED Display

The five, seven segment digital display LEDs are used to display the meter input signal readings and programming codes and settings during programming. The digital display is known as the primary display during programming. The display is available in red LEDs.

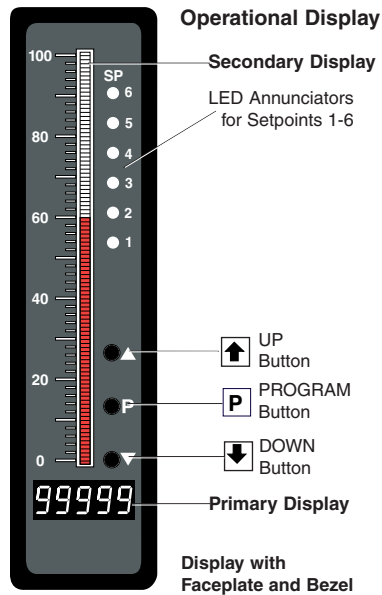

Bargraph Display

The bargraph display is a 101 segment red, green, or tri-color bargraph that can display the signal from any of four channels or the result of a processed input signal. The bargraph display is known as the secondary display during programming.

When the PROGRAM LOCKOUT switch is set to position 2, all programmable meter functions can be changed.

Program Lockout Switch

When set to the ON position, the PROGRAM LOCKOUT switch 2 prevents any programming changes being made to the meter. If programming is attempted, the meter displays [LOC]. The ON position allows programming parameters to be viewed but not changed.

See *Display without Faceplate and Bezel diagram*.

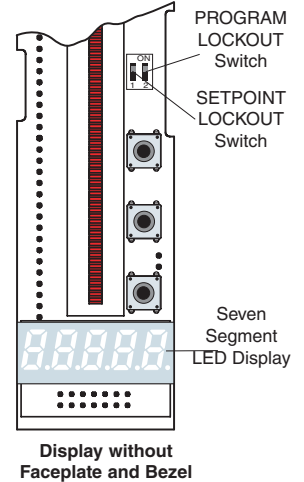

Display Text Editing with 7 Segment Alphanumeric Display Characters

Display text, such as setpoints, can be easily edited to suit your application, by connecting the meter to a PC running the free downloadable Configuration Utility program.

For Example:

Instead of [SP_1]

Instead of [SP_2]

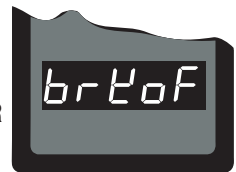
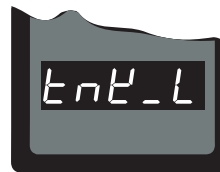

could be used for

could be used for

Scrolling Display Text Messaging

Scrolling display text messaging can be configured to run but requires a simple compiler generated macro.



Display Text Characters

The following text characters are used with the 7-segment display.

7-SEGMENT DISPLAY CHARACTERS

| | | | | | | | | | |
|---|---|---|---|---|---|---|---|---|---|
| 1 | 2 | 3 | 4 | 5 | 6 | 7 | 8 | 9 | 0 |
| A | b | c | d | E | F | G | h | i | J |
| k | L | n | o | p | q | r | s | | |
| t | u | v | w | x | y | z | | | |

Setpoint Lockout Switch

When the SETPOINT LOCKOUT switch 1 is set to the ON position, the setpoints can be programmed. Once the setpoint values have been entered and the SETPOINT LOCKOUT switch set to the ON position, the setpoints can be viewed but not changed.

See *Display without Faceplate and Bezel diagram*.

Error Message [Err]

Error messages usually occur during calibration procedures. The three most likely causes of an error message are:

- 1) The full scale and zero signals were too similar.
Note, the high input (full scale) signal must be at least 1000 counts greater than the low input (zero) signal (positive and negative values are allowed).
- 2) The scaling requirement exceeded the capability of the meter (-19999 to +99999).
- 3) No input signal present, or incorrect connections.

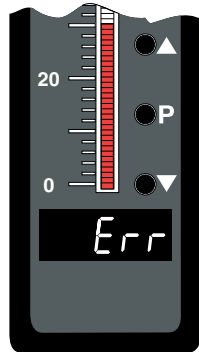

Display Showing [Error] Message

Rear Panel External Switched Inputs

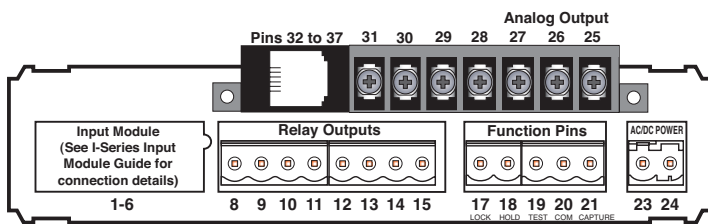

Lock Pin

By configuring Code 9 to [XX0], connecting the LOCK pin (pin 8 on the main PCB) to the COMMON pin (pin 11 on the main PCB), locks out the main and setpoint programming modes. All meter programming codes and setpoints can be viewed but not changed.

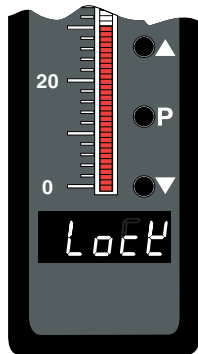

Display Showing [LoCK] Message

The main programming mode can be entered, but only the brightness setting adjusted. After adjusting the brightness setting, pressing the [P] button displays [LoCK].

The LOCK pin can also be configured in Code 9 to carry out the following functions (see *Meter Programming Codes* on Page 9):

- Reset channel 1 [XX1].
- Reset channel 2 [XX2].
- Reset channel 3 [XX3].
- Reset channel 4 [XX4].
- Reset tare [XX5].
- Reset total 1 [XX6].
- Unlatch (de-energize) all setpoints [XX7].

Hold Pin

Configure Code 9 to [X0X]. When the HOLD pin (pin 9) is connected to the COMMON pin (pin 11) the displayed reading is frozen. However, A/D conversions and all control functions continue and as soon as pin 9 is disconnected from pin 11 by the switch, the updated reading is instantly displayed.

The HOLD pin can also be configured in Code 9 to carry out the following functions (see *Meter Programming Codes* on Page 9):

- Reset channel 1 [X1X].
- Reset total 1 and total 2 [X2X].
- Reset total 2 [X3X].
- Reset peak and valley [X4X].
- Reset tare [X5X].
- Set tare [X6X].
- Unlatch (de-energize) all setpoints [X7X].

Test Pin

Configure Code 9 to [0XX]. When the TEST pin (pin 10) is connected briefly to the COMMON pin (pin 11) all segments of the display and setpoint annunciators light up. Six eights and six decimal points (8.8.8.8.8.) are displayed for a short period. The microprocessor is also reset during this time, losing all RAM settings such as peak and valley, and any digital input pin settings set up in Code 9.

The TEST pin can also be configured in Code 9 to carry out the following (see *Meter Programming Codes* on Page 9):

- Reset counter channel 1 and total 2 at power-up [1XX].
- Reset counters, CH1, CH2, CH3, CH4,- total 1, and total 2 at power-up [2XX].
- Reset total 1 and total 2 at power-up [3XX].

Capture Pin

When the CAPTURE pin (pin 12) is connected to the COMMON pin (pin 11), the CAPTURE pin can be programmed for setpoint/relay activation or macro control applications in the setpoint control settings mode of the setpoint programming mode [SPC_X] [X2X].

Common Pin

To activate the LOCK, HOLD, TEST and CAPTURE pins from the rear of the meter, the respective pins have to be connected to the COMMON pin (pin 11).

Front Panel Push Button Configuration and Setup for Programming Conventions

The meter uses a set of intuitive software codes to allow maximum user flexibility while maintaining an easy programming process. To configure the meter's programming codes, the meter uses the three right-hand side display digits. These are known as the 1st, 2nd, and 3rd digits and can be seen in the diagram opposite. To explain software programming procedures, diagrams are used to visually describe the programming steps.

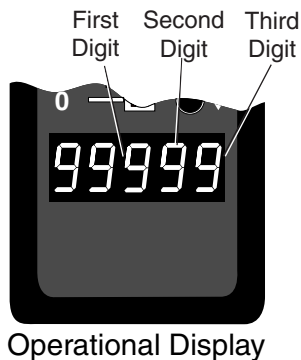

Operational Display

The following conventions are used throughout the range of Tiger 320 Series document diagrams to represent the buttons and indicators on the meter, and the actions involved in programming the meter:

Symbol

Explanation



Operational Display

The digital display showing 99999 represents the **OPERATIONAL DISPLAY**. After the meter has been powered up, the display settles and indicates the calibrated input signal. This is known as the operational mode and is generally referred to as the operational display throughout the documentation.

All programming modes are entered from this level.



This symbol represents the **PROGRAM** button. In a procedure, pressing the program button is always indicated by a **left hand**. A number indicates how many times it must be pressed and released, or for how long it must be pressed before releasing.

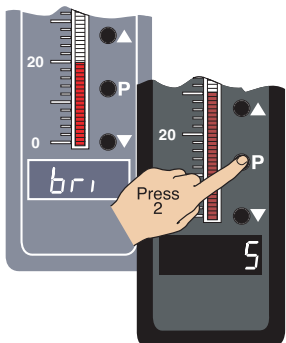

This symbol represents the **UP** button. Shown in a diagram, pressing the UP button is always indicated by a **right hand**.



This symbol represents the **DOWN** button. Shown in a diagram, pressing the DOWN button is always indicated by a **right hand**.

Where two right hands are shown on the same diagram with the word OR between them, this indicates that both the UP and DOWN buttons can be used to adjust the display: UP for increase, DOWN for decrease.

[Span]

[10000]

Text or numbers shown between square brackets in a description or procedure indicate the programming code name of the function or the value displayed on the meter display.

Programming procedures are graphic based with little descriptive text.

Each procedure shows a number of meter panel displays running in procedural steps from the top to the bottom of the page.

If need be, the procedure may run into two columns with the left column running down the page and continuing at the top of the right-hand column. Each action performed by the user is shown as a numbered step.

Each procedural step shows the meter display as it looks before an action is performed. The hand or hands in the procedural step indicate the action to be performed and also how many times, or for how long, the button is to be pressed.

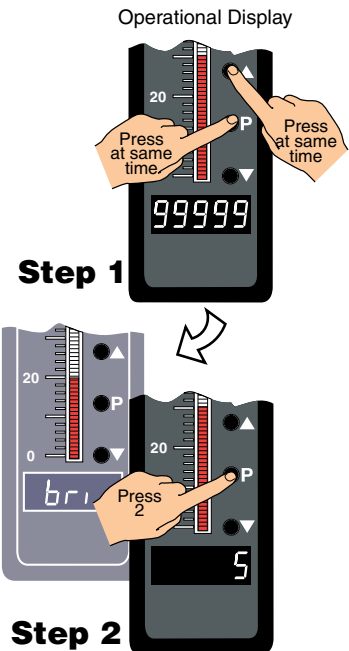

For example, the diagram to the right shows the meter in the operational display. With a left hand pressing the P button and a right hand pressing the UP button, the user is entering the **main programming mode**. This is indicated by the next diagram displaying [bri] and [5]. This is the display brightness mode and is the first sub-menu of the main programming mode.

Where a left and right hand are shown on separate buttons on the same diagram, this indicates that the buttons must be pressed at the same time.

The only exception to this rule is when carrying out the *Model and Software Code Version Check*.

When two displays are shown together as black on grey, this indicates that the display is toggling (flashing) between the name of the function and the value or configuration setting.

Where a number is not definable, the default setting [000] is shown.

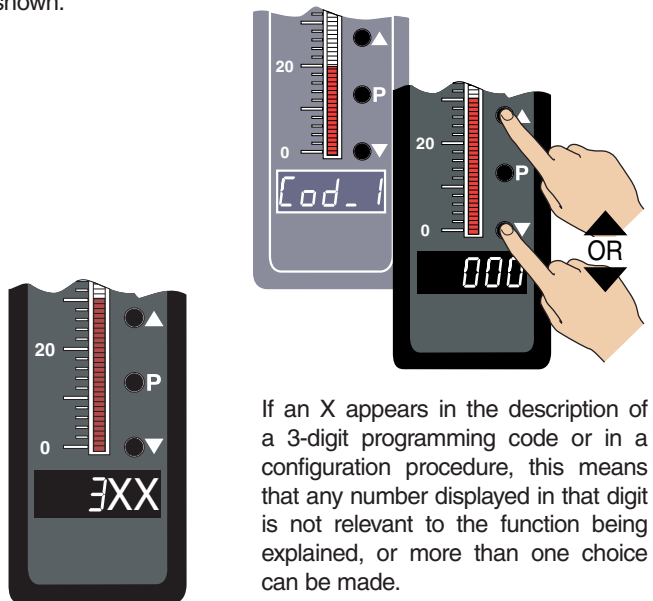

If an X appears in the description of a 3-digit programming code or in a configuration procedure, this means that any number displayed in that digit is not relevant to the function being explained, or more than one choice can be made.

Front Panel Programming Codes

The meter's programming codes are divided into two modes: the **main programming mode**, and the **setpoint programming mode** (See Diagram below). Each mode is accessible from the operational display.



Programming Tip

The easiest and fastest way to configure the Tiger 320 is to use a PC with the free downloadable configuration utility program.

Main Programming Mode

The main programming mode provides access to program all meter functions, except setpoints.

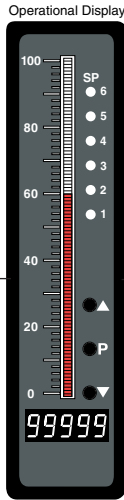

Setpoint Programming Mode

The setpoint programming mode provides access to program all setpoint and relay functions.

To enter or exit the Main Programming Mode, press **P** and **↑** at the same time

Main Programming Mode

To enter or exit the Setpoint Programming Mode, press **P** and **↓** at the same time

Setpoint Programming Mode

- [br]** Display Brightness
- P**
- [CAL]** Calibration Modes for Input and Output
- P**
- [Cod_1]** Code 1 – Display Configuration
- P**
- [Cod_2]** Code 2 – CH1 Measurement Task & Sampling Rate
- P**
- [Cod_3]** Code 3 – CH1 Post Processing & Serial Mode Functions
- P**
- [Cod_4]** Code 4 – CH2 Measurement Task & Sampling Rate
- P**
- [Cod_5]** Code 5 – CH3 Functions
- P**
- [Cod_6]** Code 6 – CH4 Functions
- P**
- [Cod_7]** Code 7 – Result Processing
- P**
- [Cod_8]** Code 8 – Data Logging & Print Mode
- P**
- [Cod_9]** Code 9 – Functions for Digital Input Pins
- P**
- [Cod10]** Code 10 – Bargraph Setup

Setpoint Activation Values Mode

Enter these menus to adjust SP activation values

Programming Tip

Save SP Settings & Exit
To save a new setpoint configuration setting and return to the operational display at any point, press the **P** button once. Then press the **P** and **↓** button at the same time to exit.

- [SP_1]** Setpoint 1
- P**
- [SP_2]** Setpoint 2
- P**
- [SP_3]** Setpoint 3
- P**
- [SP_4]** Setpoint 4
- P**
- [SP_5]** Setpoint 5
- P**
- [SP_6]** Setpoint 6

Setpoint & Relay Control Settings Mode

Enter these menus to configure SP control values

- [SPC_1]** Setpoint 1
- P**
- [SPC_2]** Setpoint 2
- P**
- [SPC_3]** Setpoint 3
- P**
- [SPC_4]** Setpoint 4
- P**
- [SPC_5]** Setpoint 5
- P**
- [SPC_6]** Setpoint 6

The *Setpoint and Relay Control Settings* diagram on Pages 41 and 42 shows the three digit configuration settings that are applied individually to each setpoint.

See Page 40 for an example procedure to configure a setpoint for simple relay functions.



Programming Tip

Save Code Settings & Exit
To save a new main programming mode configuration setting and return to the operational display at any point, press the **P** button once. Then press the **P** and **↑** button at the same time to exit.



Operational Display

View Modes

While in the operational display, pressing the button allows you to view but not change the following parameters:

- Channel 1.
- Channel 3.
- Setpoint 1.
- Setpoint 3.
- Setpoint 5.
- Peak (of CH1).
- Total 1 (total of CH1).

While in the operational display, pressing the button allows you to view but not change the following parameters:

- Channel 2.
- Channel 4.
- Setpoint 2.
- Setpoint 4.
- Setpoint 6.
- Valley (of CH1).
- Total 2 (total of CH2).

Pressing both the and buttons at the same time while in either the peak, valley, total 1, or total 2 view modes resets the setting to the current displayed signal.

Operational Display

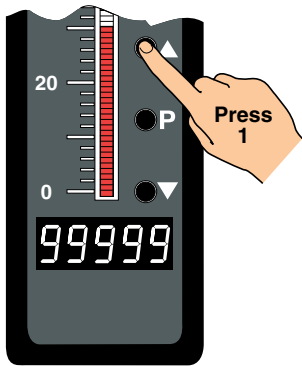

To view, press the button:

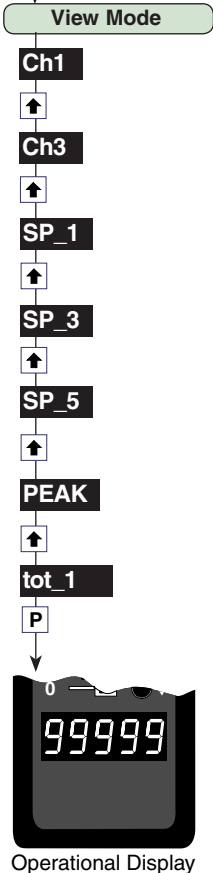

Operational Display

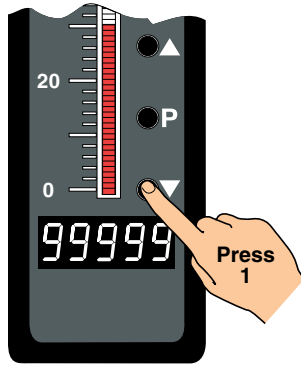

To view, press the button:

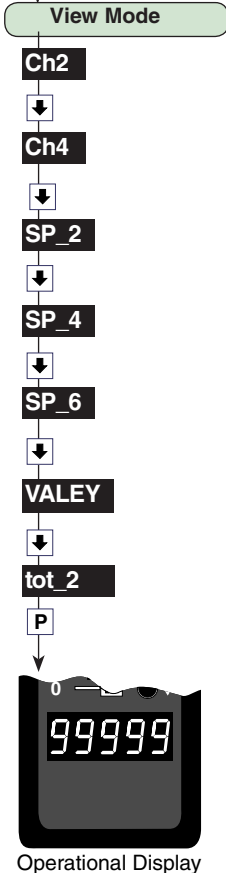

On Demand Modes

The meter can be programmed to activate the following functions on demand by pressing the button for 4 seconds:

- Tare.
- Single-point calibration.
- Two-point calibration.
- Primary input compensation.
- Manual loader (manual offset).
- Print.

The on demand function is selected in the calibration mode.

Operational Display



After configuring an on demand function in the **Calibration On Demand Mode**, press the button for 4 seconds to activate one of the following selected on demand modes.

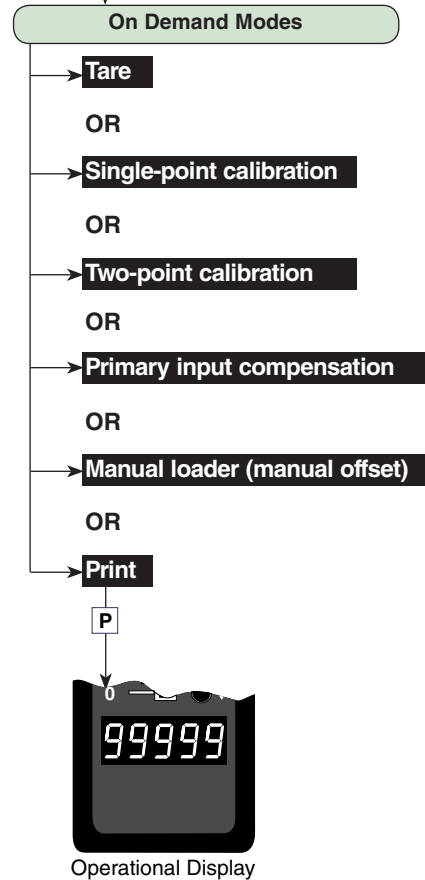

For a full breakdown of all programming codes, see the **Tiger 320 Series Programming Code Sheet (NZ101)**.

Initial Setup Procedures

Before configuring the meter, carry out the following meter configuration checks:

- Model and software code version check.
- Code blanking and macro check.

After powering-up the meter, check the model and software code version number and note this in your user manual.

Model and Software Code Version Check

The meter model and software code version number can be checked at any time while in the operational display using the following procedure.

MODEL AND SOFTWARE CODE VERSION CHECK PROCEDURE

START HERE

MODEL & SOFTWARE CODE VERSION CHECK

Step 1

Press and hold the and buttons

Operational Display



Step 2

While holding both buttons, press the Prog. button then release all three buttons

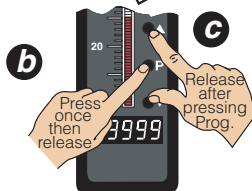

Step 3

The displays toggle three times. If a macro is installed and turned on, the customer ID and the macro ID scroll across the display before returning to the operational display.

Example
Model Number

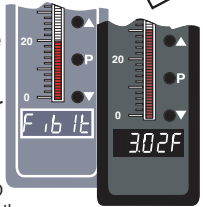

Typical Software Version Number



Operational Display

Model No:.....
Software Version No:.....
Customer ID:.....
Macro ID:.....



Programming Tip

The *Model and Software Code Version* checking procedure can be performed at any time without interfering with other configuration settings.

Code Blanking and Macro Check

320 Series meters have the ability to hide (blank out) all or some programming codes, making them tamper-proof. This can only be done using the Meter Configuration program.

With code blanking turned ON, all main and setpoint codes that have been blanked out during factory programming are hidden, preventing them from being reprogrammed. Any codes that have not been blanked out are still visible and can be reprogrammed.

Turning code blanking OFF means all meter programming codes are visible when you enter the programming modes and can be reprogrammed.

A macro is a set of commands that run automatically when the meter is powered up. We have a growing library of macros to suit a wide range of standard customer applications.

Macros can be installed in the meter at the factory during initial programming or by the customer at some later date. Macros are written and compiled using the BASIC Compiler program, and loaded into the meter using either the BASIC Compiler program or the Meter Configuration program.

Turning the macro OFF means that the meter will not perform the automatic commands pre-programmed to run with the macro.

Unless requested to blank out all or some programming codes and/or run a macro, we will program the meter in the code blanking OFF and macro OFF (default) setting.

To turn the code blanking and macro settings from ON to OFF:

START HERE

CODE BLANKING & MACRO CHECK PROCEDURE

Step 1

Press and hold the and buttons

Operational Display



Step 2

While holding both buttons, press the Prog. button.

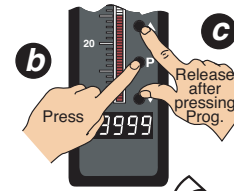

Step 3

Release the the and buttons and hold the Prog. button for approx. 1 sec then release



Code Blanking

Example

NOTE: Unless otherwise requested, the factory default setting is OFF

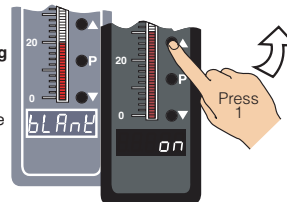

Step 4

Press the button to switch code blanking OFF

Code Blanking & Macro Check Procedure continued on next page (Step 5)

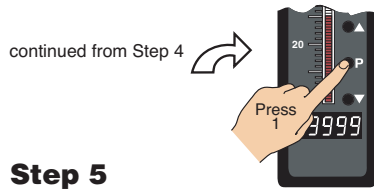

Step 5
Press the Prog. button.

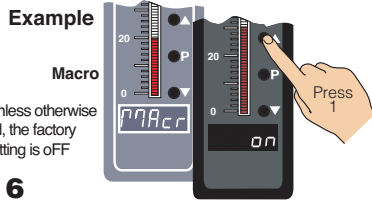

Step 6
Press the \uparrow button to switch the macro OFF

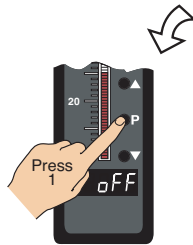

Step 7
Press the Prog. button.



Programming Tip

Code Blanking and Macro ON/OFF settings revert to the meter's original configuration settings when the meter is powered off and on.

Display Configuration

Once you have read the user manual and related supplements, and installed and powered-up the meter, configure the display to suit its designated application.

Display Brightness Mode

The **display brightness mode** is accessed when entering the main programming mode. It allows you to adjust the brightness of the display LEDs and setpoint annunciators without interfering with other configuration settings. It is always available, even with the PROGRAM LOCK switch set to ON, or the external LOCK pin connected to the COMMON pin, locking out the programming modes.

The display brightness can be set between 0 and 3, with 0 being dull and 3 being bright. The default setting is 2.

Example Procedure:
Configure the display brightness setting to 3 (bright).

START HERE

DISPLAY BRIGHTNESS MODE

Step 1
Enter Brightness Mode

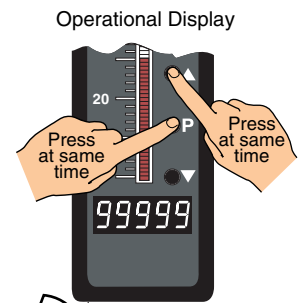

Step 2
Adjust brightness to 3

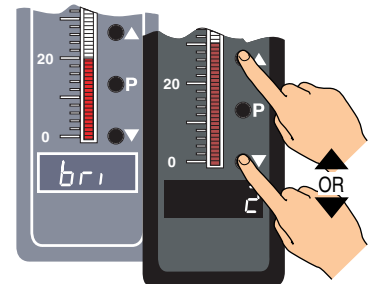

Step 3
Save brightness setting.
Exit Brightness Mode.
Return to Operational Display

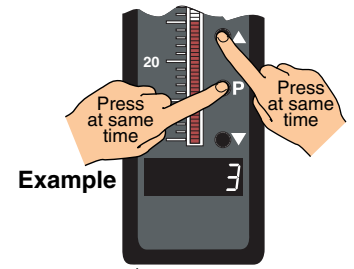

Programming Tip

The *Display Brightness* setting procedure can be performed at any time without interfering with other configuration settings by entering the main programming mode.

The Tiger 320 Series meter has an extremely powerful set of input and output calibration modes. See diagram below.

ON DEMAND Functions

In this mode the meter can be programmed to activate one of the following on demand functions by pressing the **[P]** button while in the operational display:

- On Demand TARE.
- On Demand Single-point Calibration (requires single input source).
- On Demand Two-point Calibration (requires dual input source).
- On Demand Primary Input Compensation Mode.
- On Demand Manual Loader Mode.

Calibration Modes

The following calibration modes are available:

- Manual Calibration (requires NO input source).
- **Two-point Calibration (requires dual input source).**
This is the calibration mode generally used to calibrate the meter for most applications. An example procedure has been included.
- Calibrate Thermocouple (requires K type thermocouple input source).
- Calibrate RTD (requires RTD 385 input source).
- Calibrate Smart Input Module (not available on all input modules).
- Calibrate Analog Output (requires multimeter connected to pins 16 and 17).

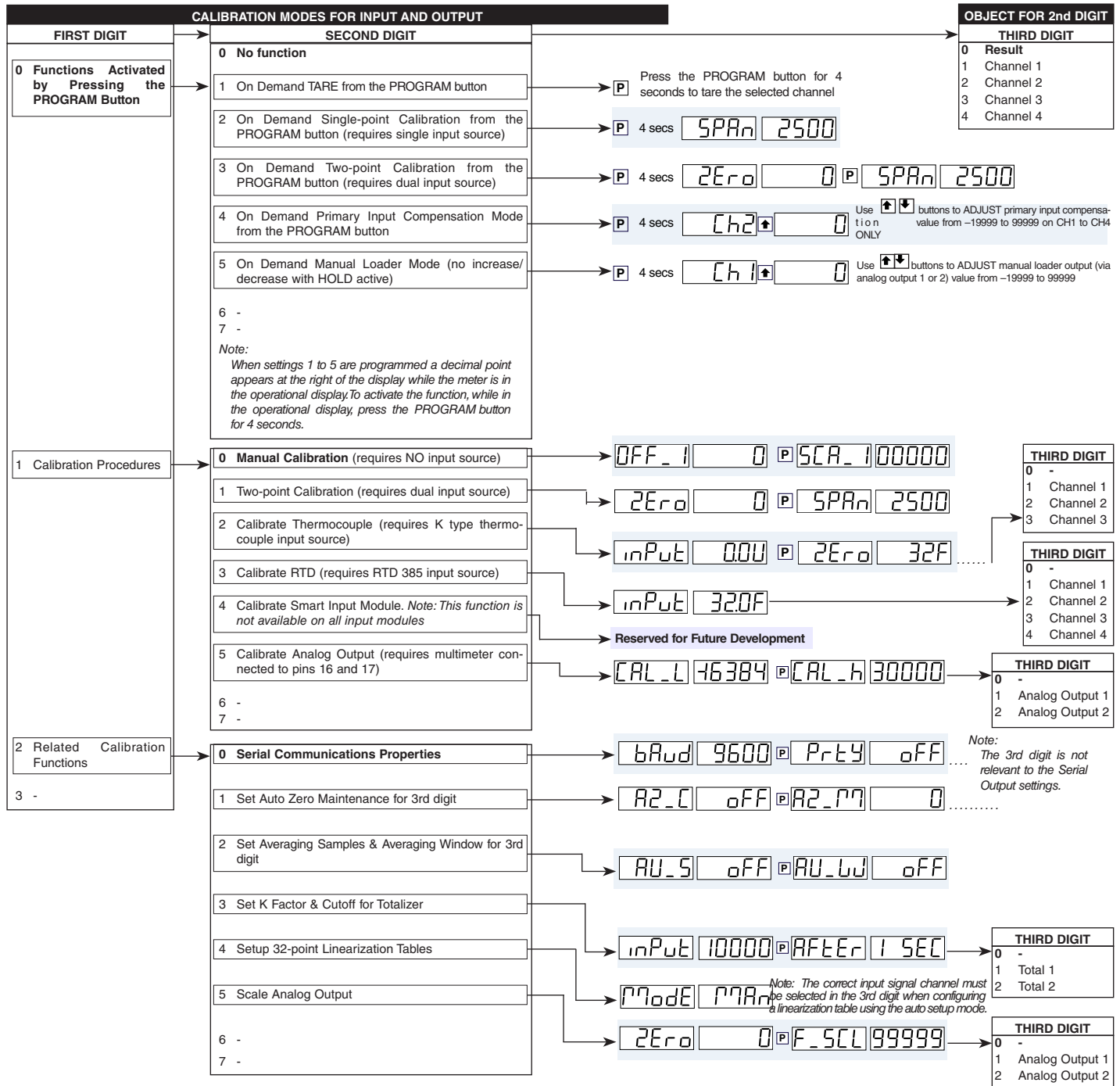

Related Calibration Functions

The following functions are also configured in the calibration mode. See *Advanced Calibration and On Demand Mode Supplement (NZ203)* for further calibration details.

Serial Communications Properties

Selecting [CAL][20X] enters the Serial Communications Properties Mode.

This mode allows you to configure the serial communications output module baud rate, parity, time delay, and address settings.

See the **calibration modes** diagram on Page 13 showing a breakdown of 1st, 2nd, and 3rd digits.

Also see the *Serial Communications Module Supplement (NZ202)* for further details on the serial communications module.

Set Auto Zero Maintenance

Selecting [CAL][21X] enters the Set Auto Zero Maintenance Mode.

This mode allows you to configure auto zero maintenance settings for weighing applications applied to the channel selected in the 3rd digit.

See the **calibration modes** diagram on Page 13 showing a breakdown of 1st, 2nd, and 3rd digits.

Set Averaging Samples & Averaging Window

Selecting [CAL][22X] enters the Set Averaging Samples and Averaging Windows Mode.

This mode allows you to configure the number of input signal samples to average over, and the size of the averaging window in display counts applied to the channel selected in the 3rd digit.

Selecting [CAL][22X] enters the Set Averaging Samples and Averaging Windows Mode. When in this mode, the [AV_S] menu allows you to select the number of input signal samples to average over. After setting the number of samples, moving to the [AV_W] menu allows you to configure the size of the averaging window in displayed counts.

The meter averages the input samples over the selected number of input samples (selected in the [AV_S] menu). This carries on in a continual process provided the input signal stays within the averaging window (set in the [AV_W] menu). If the sample moves out of the averaging window, the meter responds quickly to the change by displaying the non-averaged signal value. When the signal stabilizes, a new averaging window is established and averaging resumes.

You can program the number of samples you want to average the input signal over from 1 to 255 samples. The averaging window can be set to between 1 and 65535 counts.

See the **calibration modes** diagram on Page 13 showing a breakdown of 1st, 2nd, and 3rd digits.

See *Input Signal Sampling Showing Averaging Window diagram* opposite.

Example Procedure

The example procedure on Page 16 shows how to configure channel 1 (CH1) with an averaging sample rate of 10 counts and an averaging window of 1000 counts.

Totalizer Settings

Selecting [CAL][23X] enters the Totalizer Settings Mode.

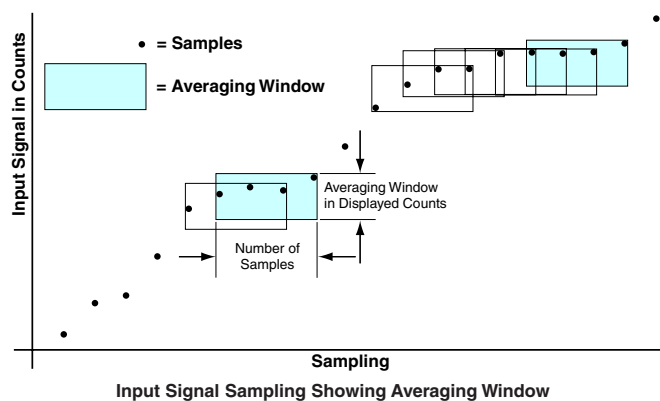

This mode allows you to configure the settings for the totalizer selected in the 3rd digit. An input value of 10000 counts is applied to a selectable time period to produce the required total value.

The cutoff is a programmable limit below which the input is not totalized.

See the **calibration modes** diagram on Page 13 showing a breakdown of 1st, 2nd, and 3rd digits.

Also see the *Totalizing and Batching Supplement (NZ208)* for further details on K factor and totalizer cutoff parameters.

Setup 32-point Linearization Tables

Selecting [CAL][24X] enters the Setup 32-point Linearization Tables Mode.

This mode allows you to set up the linearization table or tables using the manual or auto setup modes. The table or tables can then be selected to linearize the signals on channels 1 to 4.

See **Linearization Table Notes** on Page 34 for a description of memory related issues with linearization.

See the **calibration modes** diagram on Page 13 showing a breakdown of 1st, 2nd, and 3rd digits.

Also see the *Linearizing Supplement (NZ207)* for further details on linearization table setup and use.

Scale Analog Output

Selecting [CAL][25X] enters the Scale Analog Output Mode.

This mode allows you to calibrate and scale the analog output signal. Before calibrating the analog output in the calibration mode, the data source for the analog output must be configured in Code 1.

See the **calibration modes** diagram on Page 13 showing a breakdown of 1st, 2nd, and 3rd digits.

Also see the *Analog Output Module Supplement (NZ200)* for further details on the analog output module.

Also see *Configure Data Source Procedure* on Page 22 for an example of setting the analog output data source.

Calibration Mode Procedures Supplement

The *Advanced Calibration and On Demand Mode Procedures Supplement (NZ203)* describes in detail all Tiger 320 Series meter related calibration procedures configured in the calibration mode.

Two-point Calibration

Two-point calibration is the most commonly used method of calibrating Tiger 320 Series meters when a low and high input source is available.

Example Calibration Procedure

Calibrate channel 1 (CH1) using the two-point calibration method. Set the calibration mode display to [111].

The low input source is applied to the meter when setting the zero value.

The high input source is applied to the meter when setting the span value.

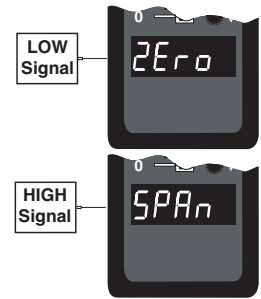

START HERE

TWO-POINT CALIBRATION

Step 1

Enter Brightness Mode

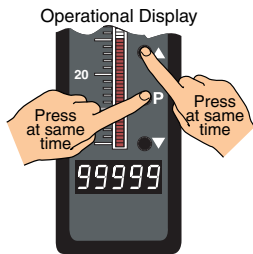

Step 2

Pass Brightness Mode and enter Calibration Mode

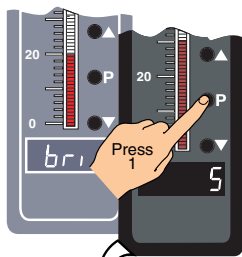

Step 3

Set Calibration Mode to [111]:
 1st Digit = 1 Selects calibration procedures
 2nd Digit = 1 Selects 2-point calibration
 3rd Digit = 1 Selects CH1 for calibration

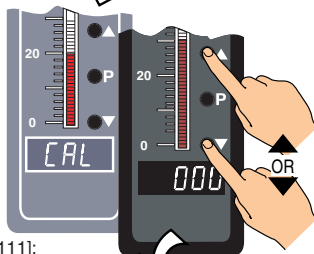

Step 4

Enter the Zero Mode

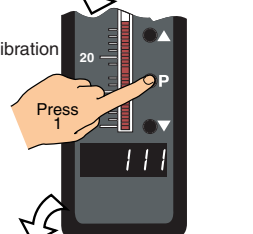

Step 5

5.1. Adjust display to desired reading for zero input
 5.2. Apply the LOW input signal

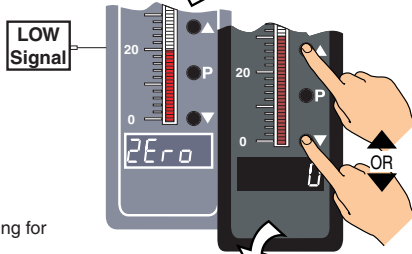

Step 6

Set reading for zero load into meter and enter Span Mode

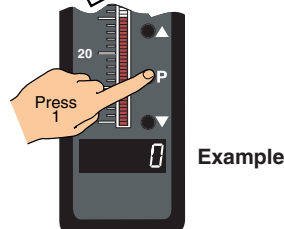

From Step 6

Step 7

7.1. Adjust display to desired reading for span input
 7.2. Apply the HIGH input signal

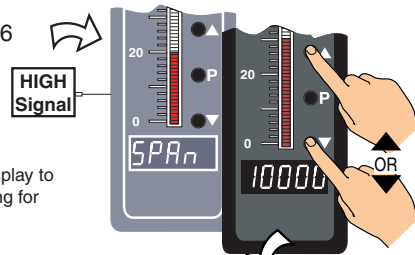

Step 8

Save zero and span settings and re-enter Calibration Mode

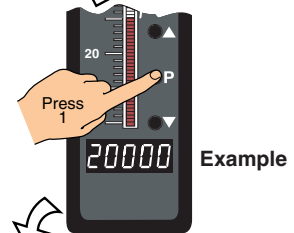

Step 9

Select the No Function Calibration Mode [000]

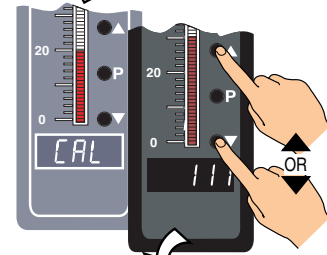

Step 10

Save Calibration Mode [000] setting and enter Code 1



Step 11

Exit Code1. Return to Operational Display

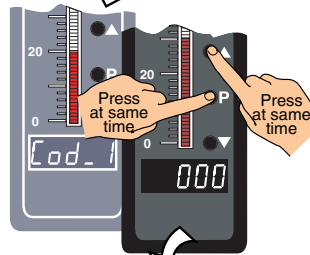

Input Signal Filtering and Averaging

Input signal filtering and averaging is configured in the calibration mode. Programmable averaging allows you to program the number of samples you want to average the input signal over (from 1 to 255 samples). A programmable averaging window provides a quick response time to large input signal changes. The averaging window can be set to between 1 and 65535 counts.

Example Procedure:

Select an averaging sampling rate of 10 samples and an averaging window of 1000 counts for Channel 1 by setting [CAL] to [221].

See *Advanced Calibration & On Demand Mode Supplement (NZ203)* for further calibration procedures.

START HERE

INPUT SIGNAL FILTERING & AVERAGING

Step 1

Enter Brightness Mode

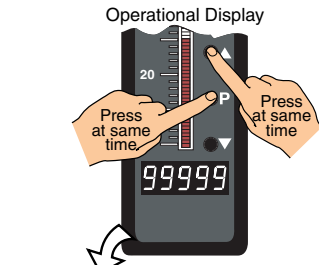

Step 2

Pass Brightness Mode and enter Calibration Mode

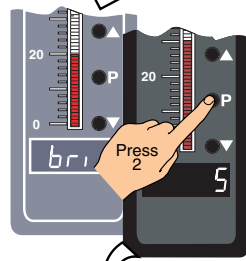

Step 3

Set calibration Mode to [221]:
 1st Digit = 2 Selects related calibration functions
 2nd Digit = 2 Selects averaging samples for 3rd digit
 3rd Digit = 1 Selects channel 1 for 2nd digit

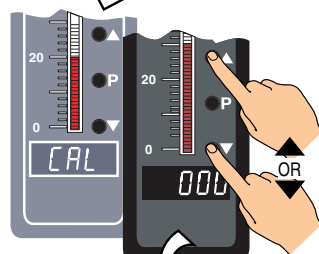

Step 4

Enter the Averaging Sampling Rate Mode

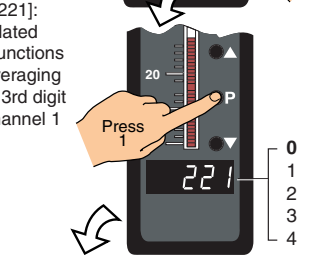

- 0 Result
- 1 Channel 1
- 2 Channel 2
- 3 Channel 3
- 4 Channel 4

Step 5

Select averaging sampling rate from 1 to 255 samples

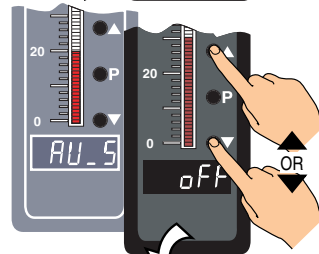

Step 6

Save averaging sampling rate setting and enter the Averaging Window mode

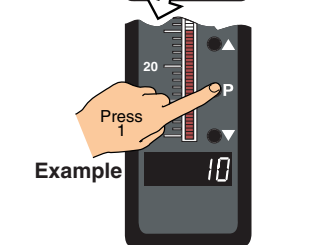

From Step 6

Step 7

Select averaging window between 1 and 65535 counts

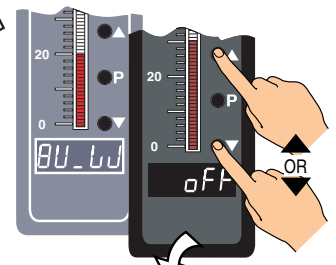

Step 8

Save averaging window settings

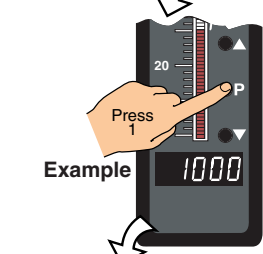

Step 9

Select [000] to leave the Calibration Mode

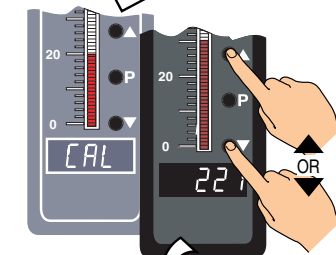

Step 10

Save settings

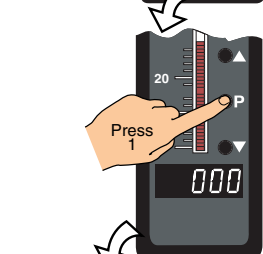

Step 11

Exit Code1. Return to Operational Display

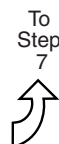
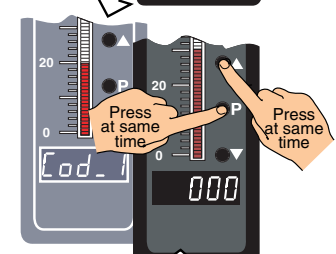

[Code 1] - Display Configuration

All digital display configuration modes, except the display brightness mode, are configured in Code 1.

All bargraph display configuration modes are configured in Code 10 (See diagram below).

See Code 1 diagram on Page 23 for a breakdown of 1st, 2nd, and 3rd digit settings.

See Code 10 diagram on Page 24 for a breakdown of 1st, 2nd, and 3rd digit settings.

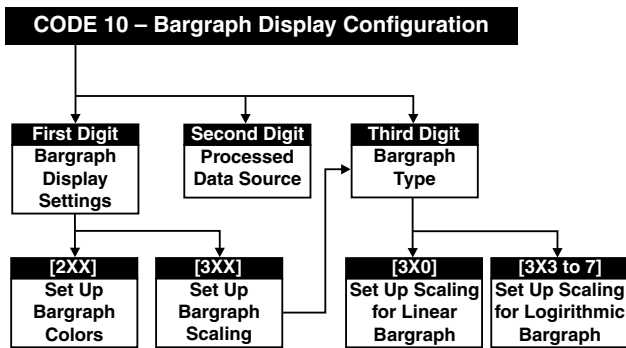
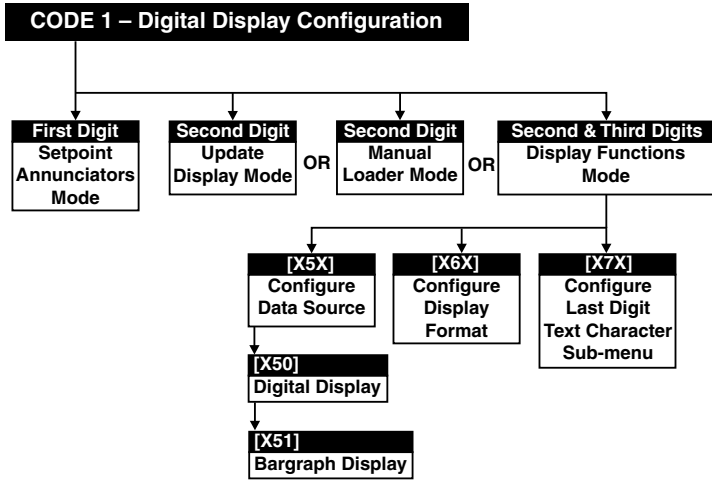

CODE 1 – Digital Display Configuration

Setpoint Annunciators Mode

The setpoint annunciators mode is configured by changing the first digit in Code 1. The setpoint annunciators can be configured to operate as follows:

- On when the setpoint activates.
- All annunciators are permanently on and each one only goes off when its setpoint activates.
- All annunciators are always off (See Note 1 on Code 1 diagram on Page 20).
- Setpoint 1 annunciator comes **on** indicating a **rising signal**. Setpoint 2 annunciator comes **on** indicating a **falling signal**.

Example Procedure. The example procedure on Page 25 shows how to select the setpoint annunciators to come ON when the setpoints are OFF (not active).

Update Display at Selected Sample Rate

The meter's default display update rate is 0.5 seconds and is

set in the second digit of Code 1 as [X0X].

The display can be configured to update at the input signal sample rate selected in Code 2.

Example Procedure. The example procedure on Page 25 shows how to configure the display to update at 50 samples per second by setting Code 1 to [X2X].

For these settings to take effect, the analog sample rate must be set at [2XX] in Code 2. See Code 2 – Channel 1 Measurement Task and Sampling Rate on Page 29 for an example.

Manual Loader Mode

The meter can be configured to function exclusively as a manual loader by setting Code 1 to [X1X].

See Analog Output Module Supplement (NZ200) for full details on manual loader mode functions.

Display Functions Mode

The display functions mode is configured by changing the 2nd and 3rd digits in Code 1:

- Selecting [X5X] enters the **Data Source** sub-menu.
- Selecting [X6X] enters the **Display Format** sub-menu.
- Selecting [X7X] enters the **Last Digit Text Character** sub-menu.

Data Source – 2nd Digit [X5X]

The **digital** display is the **primary** display. The **bargraph** display is the **secondary** display.

To select the data source for the **primary** display select **5** in the 2nd digit and **0** in the 3rd digit [X50].

To select the data source for the **secondary** display select **5** in the 2nd digit and **1** in the 3rd digit [X51].

Selecting **5** in the 2nd digit enters a sub-menu and allows the data from one of a number of meter registers to be selected as the data source for the displays or functions selected in the third digit.

Example Procedure. The example procedure on Page 22 shows how to select the data source for the **primary** display. The three digits are set to [X50]. The same example can be used for selecting the data source for the **secondary** display (bargraph). The three digits are set to [X51].

The 2nd digit in Code 1 can also be used to select the data source for the remaining functions in the 3rd digit:

- [X53] = Peak and Valley.
- [X54] = Analog Output 1.
- [X55] = Analog Output 2.
- [X56] = Totalizer 1.
- [X57] = Totalizer 2.

Display Format – 2nd Digit [X6X]

Selecting **6** in the 2nd digit enters the Display Format sub-menu where the following display format settings can all be configured:

- Last digit rounding.
- Display units (Decimal, octal, or optional 12 or 24-hour clock).
- Decimal point placement.

Example Procedure. The example procedure on Page 23 shows how to configure the three display format modes for the 3rd digit selection.

Text Character – 2nd Digit [X7X]

Selecting 7 in the 2nd digit allows you to select one of 54 characters and apply it to the last digit when the meter is in the operational display.

For example, if the meter was measuring a temperature, the display could be configured to display the reading with a C or an F in the last digit for °C or °F.

Example Procedure. The example procedure on Page 24 shows how to configure the last digit text character as “C” for centigrade (°C) for the 3rd digit selection.

Note:

After setting any or all the above three modes [X5X], [X6X], [X7X], the Code 1 display must be set back to [X0X] to leave Code 1 and carry on programming.

CODE 10 – Bargraph Display Configuration

Set Up Bargraph Colors

This mode is where the colors of the bargraph relative to the setpoints are set. Tri-color bargraphs use the following three colors:

- Green.
- Orange.
- Red.

The bargraph colors are not applied to specific setpoints. They are applied to whichever setpoint is configured at the lowest setting, and then to each next highest setpoint in turn.

Only one color is displayed on the bargraph at any time. As the signal changes, the color selected for the most recently activated setpoint displays

Only setpoints with the same source data as the bargraph are displayed.

If all six setpoints are used the colors are set as follows:

- **Color 1.** Color BELOW lowest setpoint. This is the bargraph color before it reaches a setpoint.
- **Color 2.** Color ABOVE lowest setpoint and BELOW the next highest.
- **Color 3.** Color ABOVE the 2nd lowest setpoint and BELOW the next highest.
- **Color 4.** Color ABOVE the 3rd lowest setpoint and BELOW the next highest.
- **Color 5.** Color ABOVE the 4th lowest setpoint and BELOW the next highest.
- **Color 6.** Color ABOVE the 5th lowest setpoint and BELOW the next highest.
- **Color 7.** Color ABOVE the highest setpoint.

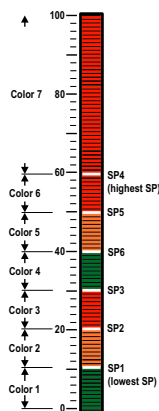

Example of Bargraph Colors

Any one of the colors (green, orange, red, or OFF – meaning no color) can be applied to each color setting (See Example: Bargraph Colors diagram above). Selecting 2 in the 1st digit enters the Set Up Bargraph Colors mode. Selections for the 2nd and 3rd digits are not relevant at this point.

Example Procedure. The example procedure on Page 26 shows how to configure the bargraph colors.

Set Up Bargraph Scaling

This mode is where the span range of the bargraph is scaled. The span range of the bargraph can be set between -19999 to 99999 counts. There are three methods of scaling the bargraph:

- Linear.
- Via Linearization Table 1.
- Logarithmic.

Selecting 3 in the 1st digit enters the Set Up Bargraph Scaling mode.

Linear Bargraph Scaling

The most common method of scaling the bargraph is through the Linear Bargraph Scaling sub-menu. In this menu the bar low, bar high, and bar nominal settings are set.

Bar Low [bAr_L] is the setting in counts required at the bottom of the bargraph.

Bar High [bAr_h] is the setting in counts required at the top of

the bargraph.

Bar Nominal sets the point on the bargraph at which the bar begins to light up. This can be any position between and including the bar low and bar high settings.

If bar nominal is set to the **bar low** setting, the bargraph behaves like a typical bargraph making the segments light up from the **bottom** of the bar and grow towards the top.

If bar nominal is set to the **bar high** setting, this makes all segments from the displayed signal to the **top** of the bar light up. As the signal increases, the number of lit segments between the signal and the bar high setting becomes steadily less. When the signal reaches the bar high setting no segments are lit.

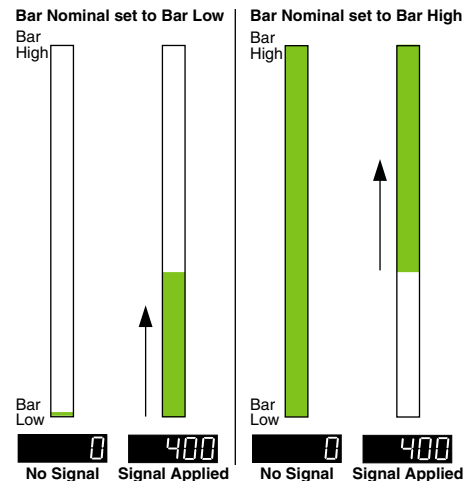

Bargraph Nominal Set Low or High

Setting bar nominal to the midpoint between bar low and bar high makes the bargraph behave like a typical center zero bargraph. This means the bargraph lights up at the center of the bar and moves either up or down the bar depending on the displayed signal.

For example, if the meter's full scale range is 20,000 counts, the midpoint is 10,000 counts. If a signal of 10,000 counts is applied, only one segment at the 10,000 count mark lights up. If a signal of 17,000 counts is applied, the segments between the center segment (10,000 counts) and the 17,000 count mark light up.

If a signal of 5000 counts is applied, the segments between the center segment (10,000 counts) and the 5000 count mark light up.

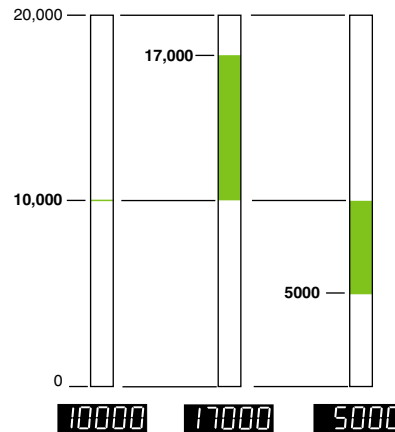

Typical Center Zero Bargraph

An added feature of this bargraph is that it can also be non-symmetrical. This means that the bar nominal setting does not need to be set at the mid-point between bar low and bar high. For example, if the bargraph is configured to display -200 to 800 °C, bar low is set to -200 counts and bar high is set to 800 counts. Bar nominal is set to 0 counts. If a signal of -50 °C is applied, the bar lights from 0 down to -50. If a signal of 600 °C is applied, the bar lights from 0 up to 600.

Example Procedure. The example procedure on Page 27 shows how to scale the bargraph using linear scaling.

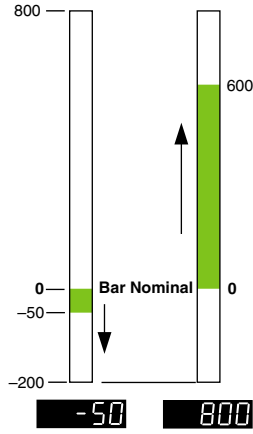

Non-symmetrical Zero Bargraph

Bargraph Scaling using Linearization Table 1

When set in this mode, the register selected to be displayed on the bargraph display (Code 1 set to [XX1]) is first processed through a 32-point flexible linearization table (Table 1) before being displayed.

This can be used, for example, if channel 1 is the required digital display while the bargraph display is the square root of channel 1.

See *Linearization Supplement (NZ207)* for full details to set up linearization Table 1.

Selecting **3** in the 1st digit and **1** in the 3rd digit selects Bargraph scaling via Linearization Table 1.

Example Procedure. To scale the bargraph using Linearization Table 1, follow the *Scale Bargraph using Linear Scaling Procedure* on Page 27. Ensure the secondary (bargraph) display has been set up in Code 1 and Linearization Table 1 has been formatted and selected for the required application.

Logarithmic Bargraph Scaling

Logarithmic scales are used in a wide variety of measurements. Probably the most well known logarithmic scale is the Richter scale for measuring earthquakes. Other log scales used include sound level (dB), radio frequency signals, power levels (dBm), and numerous radiation signals.

In all logarithmic scales a reference level is required that is the level at 0 dB. For example, in an RF measurement 0 dBm is at a reference of 1 mW.

The scale is calculated from:

$$10 \log_{10} \frac{\text{counts (input)}}{\text{reference}}$$

If the meter is scaled so that:

1 mW = 100 counts and 1 W = 100,000 counts

Then the reference for 0 dBm would be set to 100 counts:

$$10 \log_{10} \frac{(\text{input})}{100} = 0 \text{ dBm}$$

| Decade (Counts) | dBm |
|-----------------|-----|
| 1 | -20 |
| 10 | -10 |
| 100 | 0 |
| 1000 | 10 |
| 10,000 | 20 |
| 100,000 | 30 |
| 1,000,000 | 40 |

Now every 10 dBm represents a decade, the bargraph can be scaled to a different amount of bars per decade (as set in the 3rd digit).

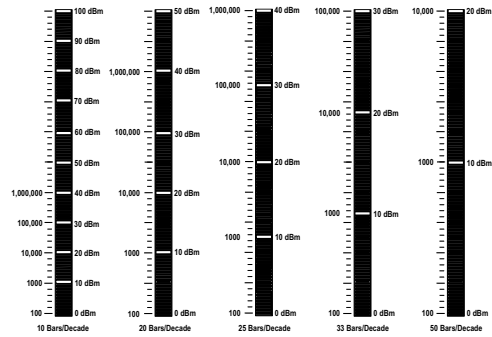

Example of Bars per Decade

Reference. This is the number of counts displayed for a 0 dB reference. Range: 1 to 99999 counts.

Bar Nominal. See Bar Nominal description under heading: *Linear Bargraph Scaling*.

Selecting **3** in the 1st digit and **3, 4, 5, 6, or 7** in the 3rd digit enters the Set Up Scaling for Logarithmic Bargraph sub-menu:

- Selecting **3** in the 3rd digit sets the log to 10 Bar/Decade.
- Selecting **4** in the 3rd digit sets the log to 20 Bar/Decade.
- Selecting **5** in the 3rd digit sets the log to 25 Bar/Decade.
- Selecting **6** in the 3rd digit sets the log to 33 Bar/Decade.
- Selecting **7** in the 3rd digit sets the log to 50 Bar/Decade.

Example Procedure. The example procedure on Page 28 shows how to scale the bargraph using example logarithmic settings.

Bargraph Display Format

After the bargraph colors have been set and the bargraph scaled, the display format can be set. This is normally the final setting. The 2nd digit selects the format of the bargraph display. There are four display format settings available:

- **Setpoints on Bar.** Selecting [X0X] means that the setpoints are displayed on the bar as lit segments in the current display color. When the display color changes, the setpoint segments change to that color. When the bargraph lights up on or beyond a setpoint, the setpoint segment goes out.

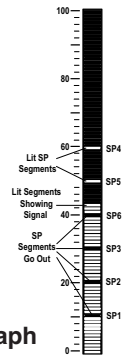

Example of Setpoints on Bargraph

- **Peak and Valley on Bar.** Selecting [X1X] means that peak and valley are displayed as lit segments and are updated as they change. The setpoints are not displayed.
- **Min/Max with Setpoints.** Selecting [X4X] means that the segments of the bar remain lit over the minimum and maximum signal variations. The setpoints are displayed as lit segments.

This is a useful mode for seeing process variations at a glance.

Note:

When moving from another display format to the **Min/Max with Setpoints** mode, the peak and valley settings must be set to the current settings by entering the Peak View mode or Valley View mode and pressing the UP and DOWN buttons at the same time.

Example: Peak and Valley on Bargraph

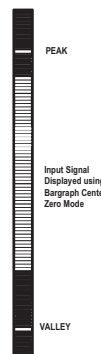

When moving from **Min/Max with Setpoints** mode to another display format, the bar nominal [bAr_n] setting must be reset to its original settings in Code 10 [3XX].

- **Bar Only.** Selecting [X7X] means that only the bargraph display signal is displayed on the bar. Setpoints and peak and valley are not displayed.

Example: MIN and MAX on Bargraph

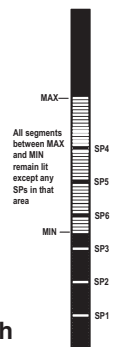

| FIRST DIGIT | SECOND DIGIT | THIRD DIGIT |
|---|---|---|
| CODE 1 – DISPLAY CONFIGURATION | | |
| FRONT PANEL ANNUNCIATORS | DISPLAY FUNCTIONS | SELECT DATA SOURCE FOR |
| 0 ON when Setpoints are ON (relay energized) 1 ON when Setpoints are OFF (relay de-energized) 2 Always OFF. See Note 1 3 LED SP1 ON indicates RISING signal trend. LED SP2 ON indicates FALLING signal trend. | 0 Normal Display Mode (i.e. operational display shows selected register) updates every 0.5 seconds 1 Manual Loader Mode (Direct Display). See Note* 2 Update at sample rate selected in Code 2 3 - 4 - 5 Select data source as per 3rd digit. See Note 4 6 Select display format as per 3rd digit. See Note 4 7 Select text character as per 3rd digit. See Note 4 | 0 Primary Display 1 Second Display. See Note 2 2 Third Display. See Note 2 3 Peak/Valley 4 Analog Output 1 5 Analog Output 2 6 Totalizer 1 7 Totalizer 2 |
| | | SELECT DISPLAY FORMAT FOR |
| | | 0 Result 1 Channel 1 2 Channel 2 3 Channel 3 4 Channel 4 5 Default Display 6 Total 1 7 Total 2 |
| | | SELECT TEXT CHARACTER FOR |
| | | 0 Result 1 Channel 1 2 Channel 2 3 Channel 3 4 Channel 4 5 Default Display 6 Total 1 7 Total 2 |

Select Data Source
See diagram below

Select Display Format
See diagram below

Select Last Digit Text Character
See diagram below

*Note *:*
 For the Manual Loader Mode (Direct Display) to work, with Code 1 set to [X54] the data source for the analog output (1 or 2) must be set to [diSP].
 Operating range upper and lower limits can be set for the manual loader mode.
 The setpoint activation values for setpoint 5 becomes the upper limit and setpoint 6 becomes the lower limit.
 When either the direct display or on demand manual loader mode is programmed into the meter, the values for setpoint 5 and setpoint 6 are activated as upper and lower limits.
See Analog Output Supplement for further details.

Note 1:
 LED annunciators are always off, except when the meter is in single channel VOLTAGE or CURRENT mode and Code 3 = [X6X], or Code 7 = [X6X] in which case the LEDs indicate which 32-point table has been selected from the rear pins (SP1 = Table 1, SP2 = Table 2, SP3 = Table 3, SP4 = Table 4).

Select Data Source



[100] [10] [1] [diSP] [rESLt] [Ch1]
 [200] [Ch2]
 [244] [Ch3]
 [IArE] [VALEY] [PEAK] [tot_2] [tot_1] [Ch4]

Use the [up/down] buttons to cycle through the Registers Menu and Registers (1 to 244) to select data source for displays, peak and valley, totalizers and analog output (also see page 43).

Display Format Mode

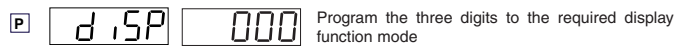

| FIRST DIGIT | SECOND DIGIT | THIRD DIGIT |
|---|---|---|
| LAST DIGIT ROUNDING | DISPLAY UNITS | DECIMAL POINT PLACEMENT |
| 0 No rounding 1 Rounding by 2's 2 Rounding by 5's 3 Rounding by 10's | 0 Decimal 1 24-hour clock mode Hours: Minutes: Seconds (6-digit version only) 2 12-hour clock mode (12:30 am is displayed as 12:30A. 12:30 pm is displayed as 12:30P) 3 24-hour clock mode Days: Hours:Minutes (6-digit version only) 4 - 5 - 6 - 7 Octal | 0 No decimal point 1 -XX.XX.XX 2 - X.XXXXX 3 X.XXXXX 4 X.XXX 5 X.XX 6 X.X 7 Decimal Point set from the rear (X.XXXX to XXXXX) See Note 3. Also See Note 4. |

Note:
 Selecting 1, 2, or 3 in the 2nd digit of this mode configures the display of the selected channel as a clock.

Note 2:
 These options are only for use with meters that have more than one display. With bargraph meters the PRIMARY display is the digital display, and the SECONDARY display is the bargraph display.

Note 3:
 These functions are only available on selected input modules.

Note 4:
 If Code 1's display modes have been entered (second digit set to 5, 6, or 7), the display will cycle between Code 1 and the display functions mode each time the PROGRAM button is pressed. To leave the cycle, the Code 1 digits must be reset to any relevant function between [X00] to [X20]. This takes you into Code 2.

Select Last Digit Text Character



Use the [up] button to cycle through the menu, and the [down] button to cycle back.

Press the Up or Down button 4 times as the next 4 characters are blank.

Note:
Data source for the bargraph is set up in Code 1 [X51].

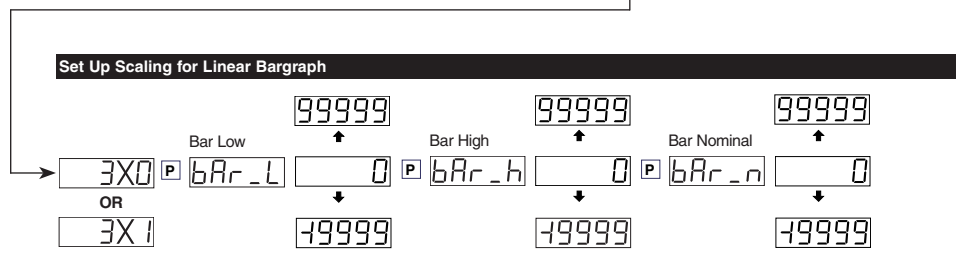
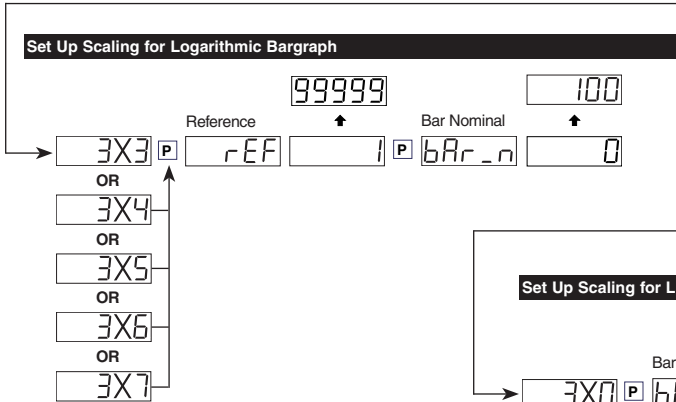
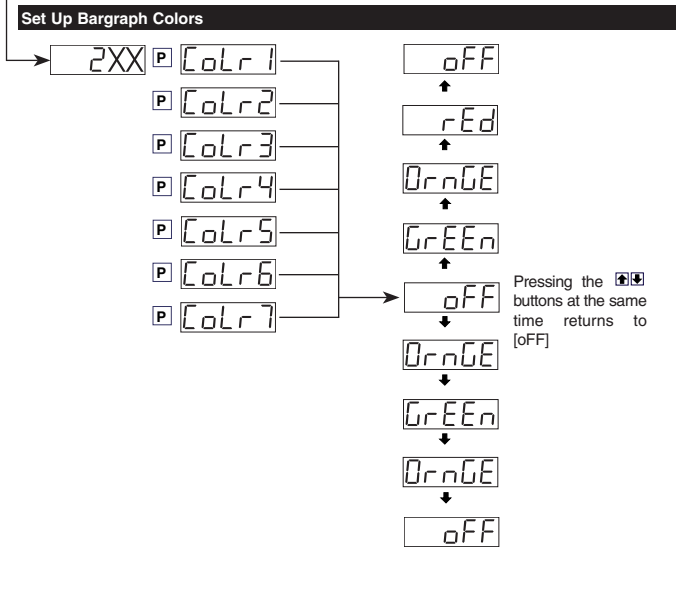
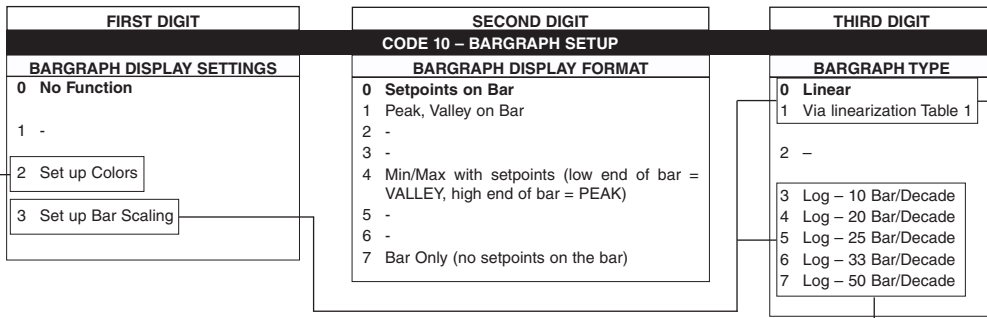

Configure Data Source Procedure

The following example procedure describes how to select the source of the data to be displayed for the third digit selection.



Programming Tip

To enter the Main Programming Mode press the **P** and **▲** buttons at the same time. To exit and return to the operational display, press the **P** and **▲** buttons again at the same time.

At the end of any procedure (Step 8 in this procedure) the **P** must be pressed before the **P** and **▲** buttons are pressed, otherwise the meter returns to the operational display without saving the new settings.

Example Procedure:

Configure the Primary Display with the display [diSP] as the data source by setting Code 1 to [X50]. See diagram at the bottom of the page for data source selection options.

Select Data Source

P SourC off

[100] [10] [1] ← [diSP] [rESL] [Ch1]
 [200] [Ch2]
 [244] [Ch3]
 [tArE] [VALEY] [PEAK] [tot_2] [tot_1] [Ch4]

Use the **▲** **▼** buttons to cycle through the Registers Menu and Registers (1 to 244) to select data source for displays (also see page 43).

START HERE
CONFIGURE DATA SOURCE

Step 1
 Enter Brightness Mode

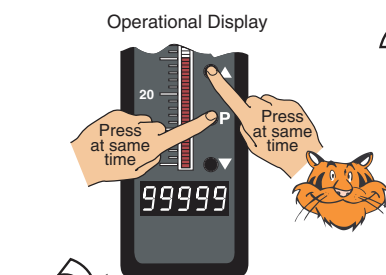

Step 2
 Pass Brightness and Calibration Modes and enter Code 1

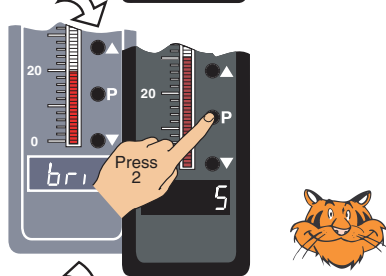

Step 3
 Set Code 1 to [X50]:
 1st Digit = X Not relevant
 2nd Digit = 5 Selects data source mode
 3rd Digit = 0 Selects primary display

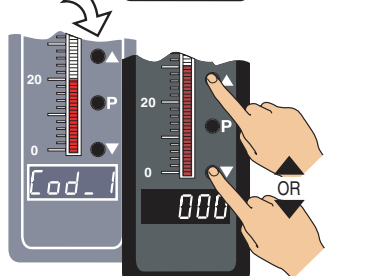

Step 4
 Enter the Data Source Mode

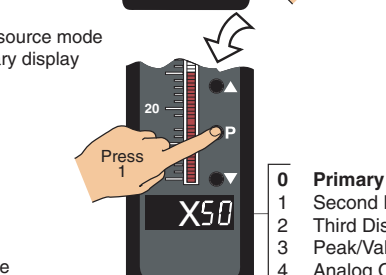

Step 5
 Select [diSP] as the Data Source from the options listed in the Select Data Source diagram below

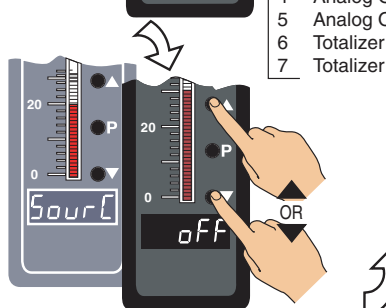

Programming Tip
 Pressing the **▼** button reaches [000] faster.

Step 7
 Select [000] to leave Code 1

Programming Tip
 Pressing the **▲** and **▼** buttons at the same time increases the displayed parameter in increments of 100 counts.

Step 8
 Save Data Source setting

Step 9
 Exit Code 2. Return to Operational Display

- 0 Primary Display
- 1 Second Display (See Note)
- 2 Third Display (See Note)
- 3 Peak/Valley
- 4 Analog Output 1
- 5 Analog Output 2
- 6 Totalizer 1
- 7 Totalizer 2

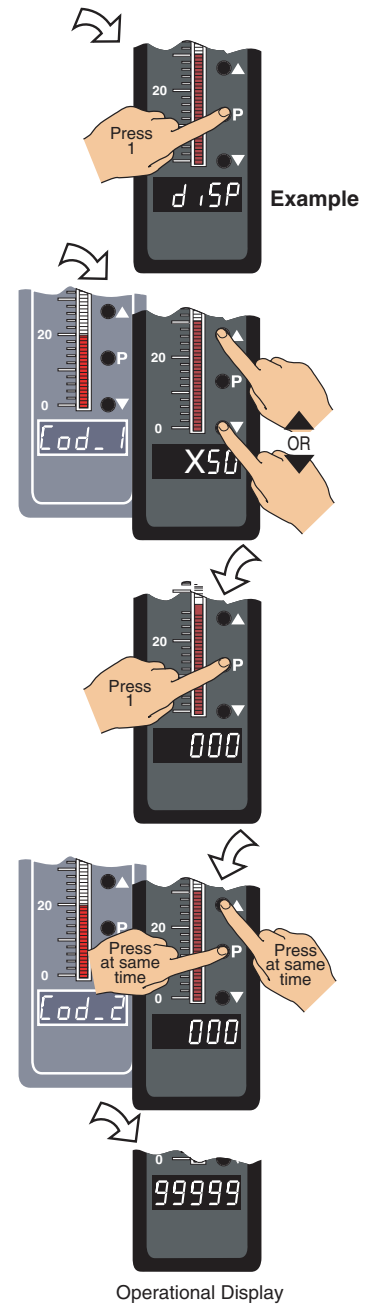

Note:
 Options 1 and 2 listed for the 3rd digit in Step 3 above are only for use with meters that have more than one display. With bargraph meters the PRIMARY display is the digital display, and the SECONDARY display is the bargraph display.

Configure Display Format Mode Procedure

The following example procedure describes how to configure the display format mode for the third digit selection and covers:

- Last Digit Rounding.
- Display Units.
- Decimal Point Placement.

Example Procedure:

Configure the display format mode for channel 1 with rounding by 2's, decimal display units, and the decimal point placed between display digits 4 and 5 by setting Code 1 to [X61] to enter the Display Format Mode.

Display Format Mode

P **d i s P** **000** Program the three digits to the required display format mode

| FIRST DIGIT | SECOND DIGIT | THIRD DIGIT |
|----------------------------|---|--|
| LAST DIGIT ROUNDING | DISPLAY UNITS | DECIMAL POINT PLACEMENT |
| 0 No rounding | 00 Decimal | 0 No decimal point |
| 1 Rounding by 2's | 1 24-hour clock mode Hours: Minutes: Seconds (6-digit version only) | 1 -XX.XX.XX |
| 2 Rounding by 5's | 2 12-hour clock mode (12:30 am is displayed as 12:30A. 12:30 pm is displayed as 12:30P) | 2 - X.XXXXX |
| 3 Rounding by 10's | 3 24-hour clock mode Days: Hours:Minutes (6-digit version only) | 3 X.XXXX |
| | 4 - | 4 X.XXX |
| | 5 - | 5 X.XX |
| | 6 - | 6 X.X |
| | 7 Octal | 7 Decimal Point set from the rear (X.XXXX to XXXXX) See Note 3 on page 20. Also See Note 4 on page 20. |

Note:
Selecting 1, 2, or 3 in the 2nd digit of this Mode configures the display of the selected channel (see Step 4) as a clock.

START HERE

CONFIGURE DISPLAY FORMAT

Step 1

Enter Brightness Mode

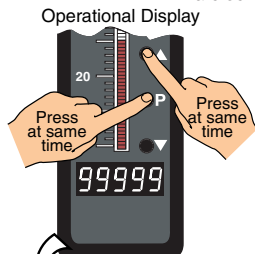

Step 2

Pass Brightness and Calibration Modes and enter Code 1

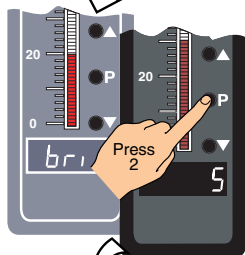

Step 3

Set code 1 to [X61]:
1st Digit = X Not relevant
2nd Digit = 6 Selects display functions
3rd Digit = 1 Selects Channel 1

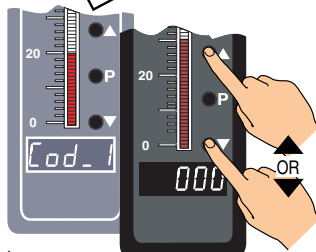

Step 4

Enter the Display format Mode

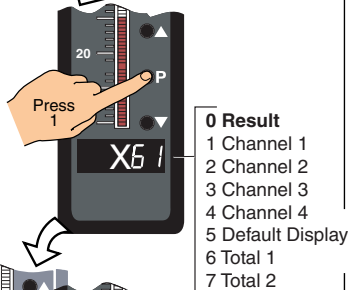

Step 5

Set the Display Format Mode to [106]:
1st Digit = 1 Rounding by 2's
2nd Digit = 0 Decimal display
3rd Digit = 6 Decimal point

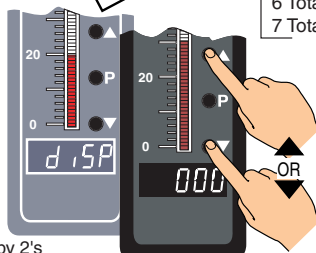

From Step 5

Step 6

Save the settings

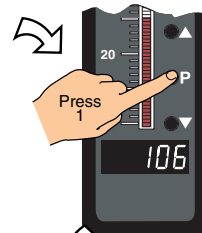

Step 7

Select [X0X] to leave Code 1

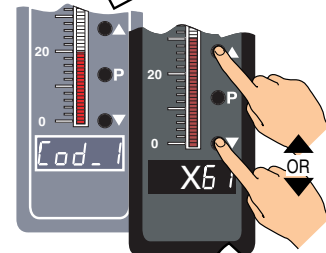

Step 8

Save Display Functions setting



Step 9

Exit Code 2. Return to Operational Display

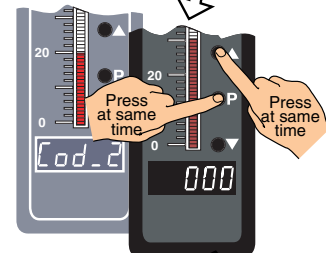

Operational Display

Configure Last Digit Text Character Procedure

The following example procedure describes how to select the last digit text character.

Example Procedure:

Configure Channel 1 with C as its last digit text character (for °C) by setting Code 1 to [X71] to enter the Select Last Digit Text Character Mode. See diagram opposite.

Select Last Digit Text Character

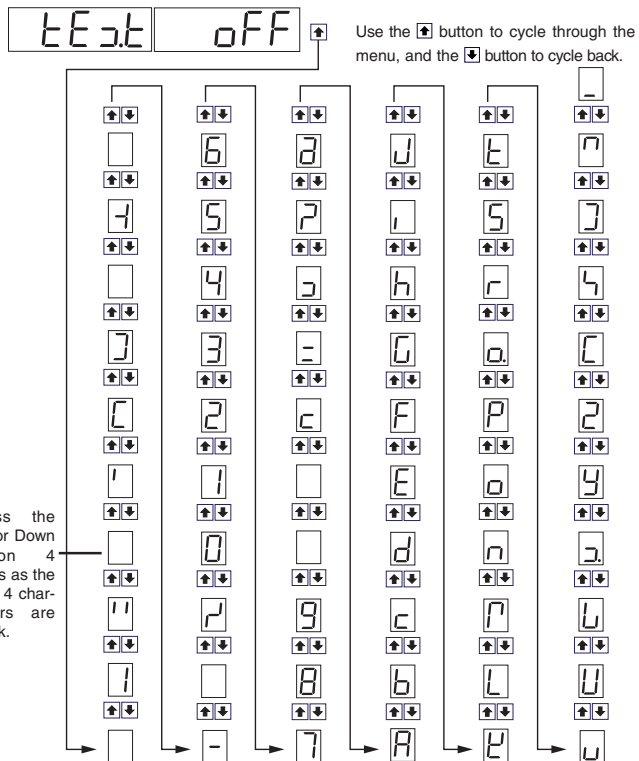

START HERE

CONFIGURE LAST DIGIT TEXT CHARACTER

Step 1

Enter Brightness Mode

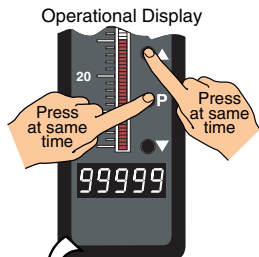

Step 2

Pass Brightness and Calibration Modes and enter Code 1

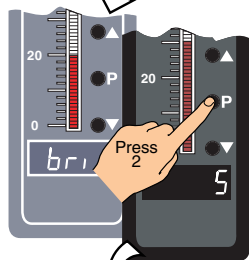

Step 3

SET CODE 1 TO [X71]:
 1st Digit = X Not relevant
 2nd Digit = 7 Selects text character mode
 3rd Digit = 1 Selects channel 1

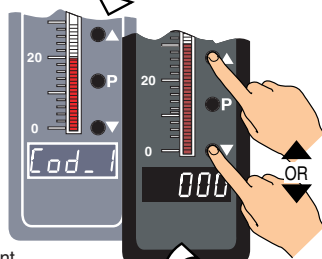

Step 4

Enter the Last Digit Text Character Mode

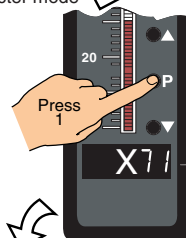

- 0 Result
- 1 Channel 1
- 2 Channel 2
- 3 Channel 3
- 4 Channel 4
- 5 Default Display
- 6 Total 1
- 7 Total 2

Step 5

Select Text Character [C] from the options listed in the diagram above

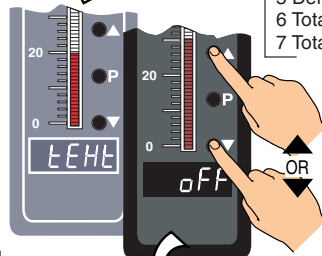

Step 6

Save the settings

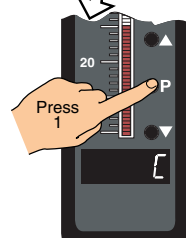

Example



From Step 6

Step 7

Select [X0X] to leave Code 1

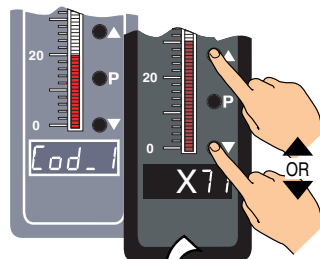

Step 8

Save Last Digit Text Character setting

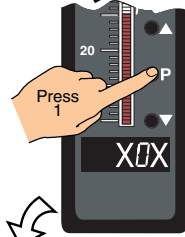

Step 9

Exit Code 2. Return to Operational Display

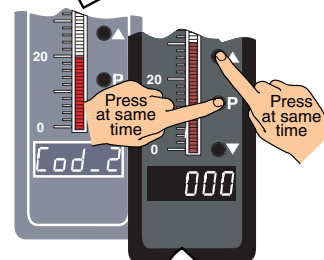

Operational Display



Configure Setpoint Annunciators Procedure

The following example procedure describes how to configure setpoint annunciators.

Example Procedure:

Configure the setpoint annunciators to come ON when the setpoints are OFF (not active) by setting Code 1 to [1XX].

START HERE

CONFIGURE SETPOINT ANNUNCIATORS

Step 1
Enter Brightness Mode

Step 2
Pass Brightness and Calibration Modes and enter Code 1

Step 3
Set Code 1 to [1XX]:
1st Digit = 1 ON when SP OFF
2nd Digit = X Not relevant
3rd Digit = X Not relevant

Step 4
Save the settings and enter Code 2

Step 5
Exit Code 2.
Return to Operational Display

Configure Update at Sample Rate Procedure

The following example procedure describes how to configure the display to update at the sample rate selected in Code 2.

Example Procedure:

Update the display at the sample rate selected in Code 2 [2XX] by setting Code 1 to [X2X].

START HERE

CONFIGURE UPDATE AT SAMPLE RATE

Step 1
Enter Brightness Mode

Step 2
Pass Brightness and Calibration Modes and enter Code 1

Step 3
Set Code 1 to [X2X]:
1st Digit = X Not relevant
2nd Digit = 2 Updates at controlled output rate
3rd Digit = X Not relevant

Step 4
Save setting and enter Code 2

Step 5
Exit Code 2.
Return to Operational Display

Programming Tip

The *Configuring Setpoint Annunciators* and the *Update at Sample Rate* procedures can be combined so that Code 1 could be set to [12X] (for the above examples) in a single procedure.

Configure Bargraph Colors Procedure

START HERE

CONFIGURE BARGRAPH COLORS

Step 1

Enter Brightness Mode

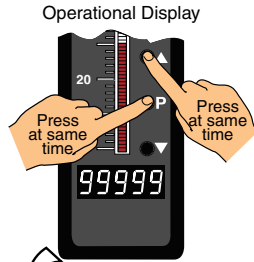

Step 2

Pass Brightness and Calibration Modes and enter Code 10

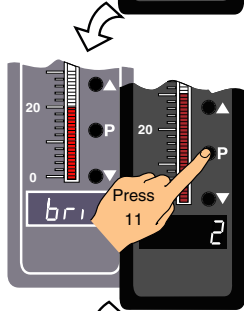

Step 3

Set Code 10 to [2XX]:
 1st Digit = 2 Set up colors
 2nd Digit = X Not relevant
 3rd Digit = X Not relevant

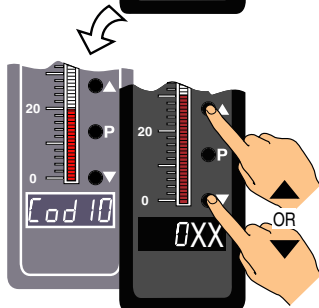

Step 4

Enter the Setup Bargraph Colors mode



Step 5

Select the color to be displayed for Color 1 (color below the lowest SP)

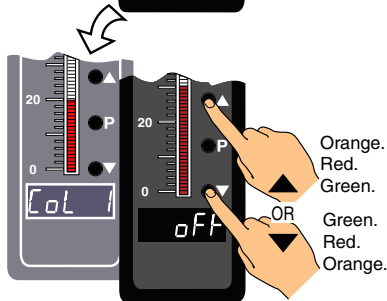

Step 6

Save Color 1 setting and enter Color 2

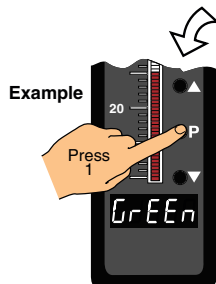

From Step 6

Step 7

Select the color to be displayed for Color 2 (color ABOVE lowest SP)

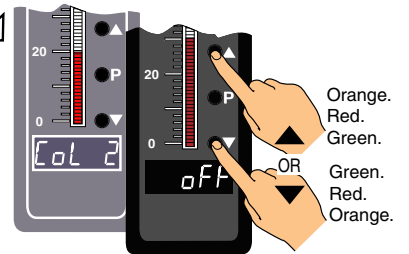

Step 8

Save Color 2 setting and enter Color 3 mode

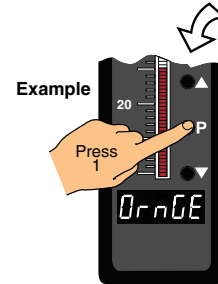

Repeat Steps 5 to 8 for all remaining color settings (Color 3 to Color 7)

Note:
 Only color settings relevant to selected setpoints need to be set. See Set Up Bargraph Colors for a description of colors and setpoints.

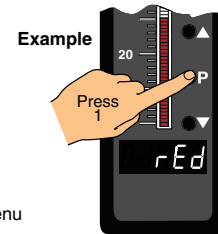

Step 9

Save the color setting for last color and return to Code 10 menu

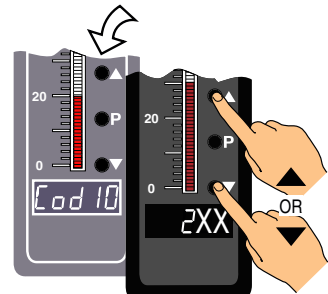

Step 10

Set Code 10 back to [0XX]:
 1st Digit = 0 No function
 2nd Digit = X Not relevant
 3rd Digit = X Not relevant

Step 11

Exit Code 10. Return to the Operational Display

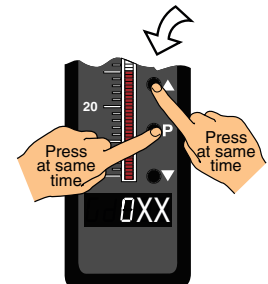

To Step 7



Scale Bargraph using Linear Scaling Procedure

START HERE

CONFIGURE BARGRAPH LINEAR SCALING

Step 1

Enter Brightness Mode

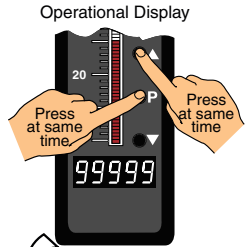

Step 2

Pass Brightness and Calibration Modes and enter Code 10

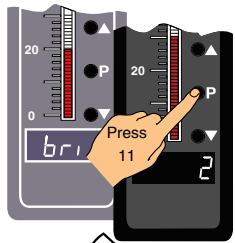

Step 3

Set Code 10 to [3X0]:
 1st Digit = 3 Set Up Bar Scaling
 2nd Digit = X Not relevant
 3rd Digit = 0 Linear

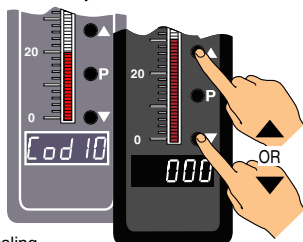

Step 4

Enter the bar low mode

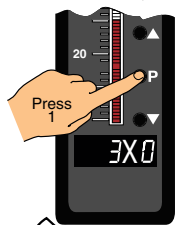

Step 5

Adjust the display to the required bar low [bAr_L] setting

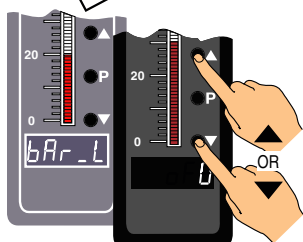

Step 6

Save [bAr_L] setting and enter bar high mode

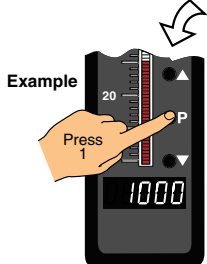

From Step 6

Step 7

Adjust the display to the required bar high [bAr_h] setting

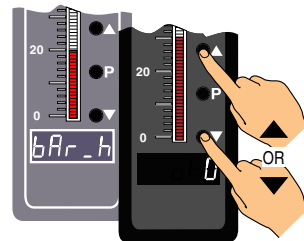

Step 8

Save [bAr_h] setting and enter bar nominal mode



Step 9

Adjust the display to the required bar nominal [bAr_n] setting

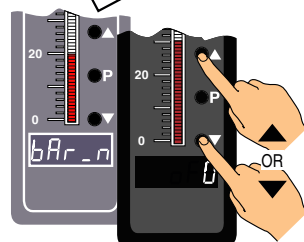

Step 10

Save the [bAr_n] setting and return to Code 10 menu

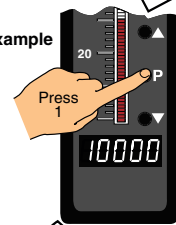

Step 11

Select bargraph display format. Set Code 10 to [0X0]:
 1st Digit = 0 No function
 2nd Digit = X Select display format
 3rd Digit = 0 Linear

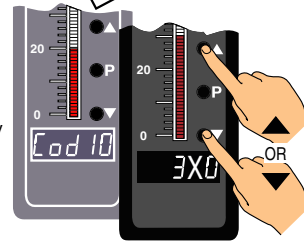

Step 12

Exit Code 10. Return to the Operational Display

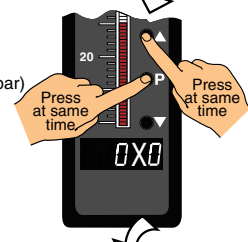

To Step 7

Operational Display



Scale Bargraph using Logarithmic Scaling Procedure

START HERE

CONFIGURE BARGRAPH LOGIRITHMIC SCALING

Step 1

Enter Brightness Mode

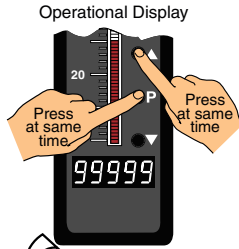

Step 2

Pass Brightness and Calibration Modes and enter Code 10

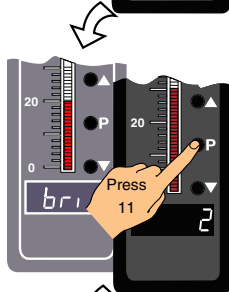

Step 3

Set Code 10 to [3X3]:
 1st Digit = 3 Set Up Bar Scaling
 2nd Digit = X Not relevant
 3rd Digit = 3 Log - 10 Bar/Decade

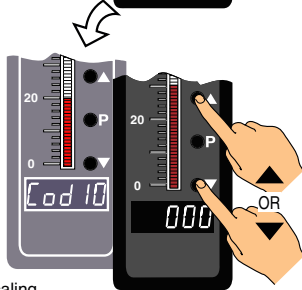

Step 4

Enter the reference [rEF] mode

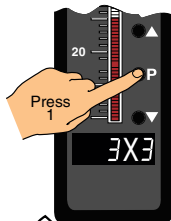

Step 5

Adjust the display to the required reference [rEF] setting

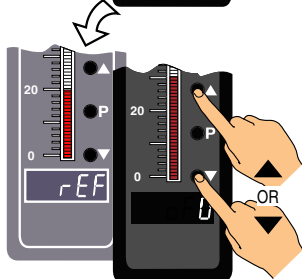

Step 6

Save [rEF] setting and enter bar nominal mode

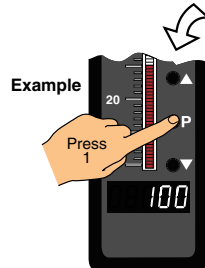

From Step 6

Step 7

Adjust the display to the required bar nominal [bAr_n] setting

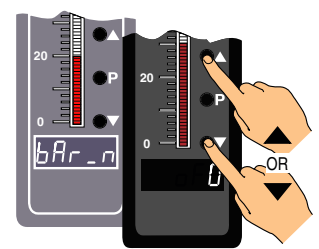

Step 8

Save [bAr_n] setting and return to Code 10

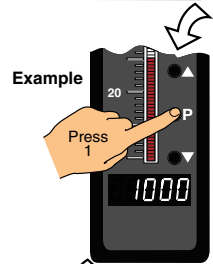

Step 9

Select bargraph display format. Set Code 10 to [0X0]:
 1st Digit = 0 No function
 2nd Digit = X Select display format
 3rd Digit = 3 Log-10 Bar

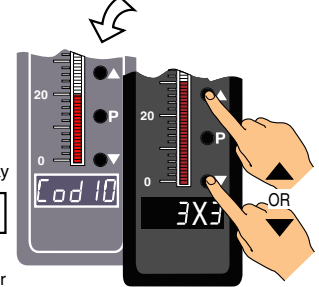

- 0 Setpoints on Bar**
- 1 Peak, valley on Bar
- 2 -
- 3 -
- 4 MIN/MAX with setpoints
- 5 -
- 6 -
- 7 Bar only (No setpoints on bar)

Step 10

Exit Code 10. Return to the Operational Display

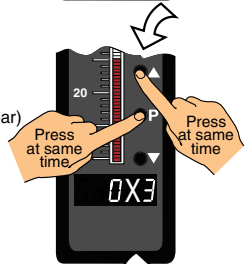

To Step 7

[CodE 2] - Channel 1 Measurement Task & Sampling Rate

The Tiger 320 Series meter can be configured to measure almost any input signal. The measurement task and sampling rate for Channel 1 (CH1) is configured in the three digits of Code 2. The diagram below lists the available configuration selections in Code 2.

Example Procedure:

Configure CH1 for a voltage input with 10 samples/second (60 Hz rejection) sampling rate and output rate of 0.1 seconds by setting Code 2 to [000].

| FIRST DIGIT | SECOND DIGIT | THIRD DIGIT |
|---|--|---|
| CODE 2 – CHANNEL 1 MEASUREMENT TASK AND SAMPLING RATE | | |
| ANALOG SAMPLE RATE 0 Sample Rate: Typically 10 samples/second (60 Hz) Output Rate: 0.1 seconds See Example 1 Sample Rate: Typically 10 samples/second (50 Hz) Output Rate: 0.1 seconds See Example 2 Sample Rate: Typically 10 samples/second (60 Hz) Output Rate: 10 milliseconds See Example 3 Sample Rate: Typically 10 samples/second (50 Hz) Output Rate: 10 milliseconds See Example <i>Note:</i> Output Rate refers to setpoint and macro outputs, and input rates from smart input modules. <i>Note:</i> All above sample rates are quoted for single channel operation. Where more than one channel is available, sample rates are divided by the number of active channels. See Example. | MEASUREMENT TASK 0 Voltage, Current 1 TC (3rd digit selects type of TC) 2 RTD 3-wire (3rd digit selects type of RTD) 3 RTD 2- or 4-wire (3rd digit selects type of RTD) 4 Frequency 5 Period 6 Counter 7 Smart Input Module Example: 10 Samples/Second 1 Channel = 10 samples/second 2 Channels = 5 samples/second 3 Channels = 3.33 samples/second 4 Channels = 2.5 samples/second | FOR VOLTAGE 0 No function 1 Peak detector 2 Pressure with Auto-cal FOR THERMOCOUPLE 0 Type J 1 Type K 2 Type R 3 Type S 4 Type T 5 Type B 6 Type N 7 Select user defined table set up in CAL [24X] FOR RTD TYPE (2-, 3-, 4- WIRE) 0 Resistance 1 RTD 385 2 RTD 392 3 RTD 120 4 Cn 10 FREQUENCY RANGE 0 99.999 Hz range from 0.010 Hz 1 99.999 Hz range from 2.000 Hz 2 999.99 Hz range from 0.01 Hz 3 999.99 Hz range from 2.00 Hz 4 9999.9 Hz range from 0.1 Hz 5 9999.9 kHz range from 2.0 Hz 6 99 kHz range from 1 Hz (1 s gate) 7 655.35 kHz range from 10 Hz (0.1 s gate) PERIOD MEASUREMENT 0 99.999 s 1 9.9999 s 2 999.99 ms 3 99.999 ms COUNTER/RESIDENT TIMER/CLOCK 0 Counter input with 16 bit Pre-scaler 1 Setting of 16-bit Pre-scaler 2 Debounced Counter with Pre-scaler 3 Up/Down Counter with Pre-scaler 4 0.1 sec Timer with Pre-scaler 5 - 6 External 24-hour clock 7 Internal 24-hour clock SMART INPUT MODULE 0 Output Register 1 1 Output Register 2 2 Output Register 3 3 Output Register 4 4 Output Register 5 5 Output Register 6 6 Output Register 7 7 Smart Input Module Setup. |

START HERE

CONFIGURE CH1 MEASUREMENT TASK & SAMPLING RATE

Step 1

Enter Brightness Mode

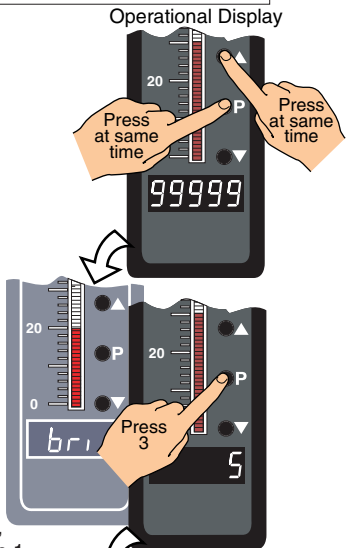

| X61 Sets Prescaler | |
|--------------------|------------|
| 1 = | 0.1 second |
| 10 = | 1 second |
| 600 = | 1 minute |
| 36000 = | 1 Hour*** |

Use buttons to set prescale values

***Note: For the 1 hour setting, the scale factor for CH1 must be set to 0.1 in the calibration mode setting [111].

Step 2

Pass Brightness Mode, Calibration Mode, Code 1, and enter Code 2

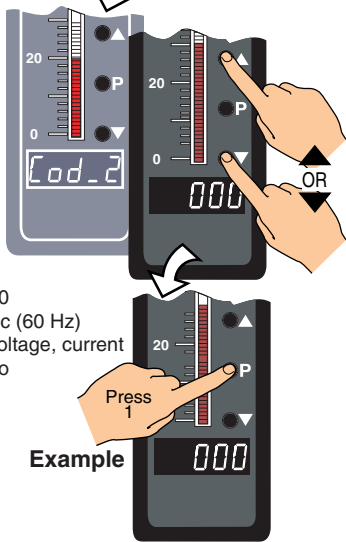

Step 3

Set code 2 to [000]:
 1st Digit = 0 Selects 10 samples/sec (60 Hz)
 2nd Digit = 0 Selects voltage, current
 3rd Digit = 0 Selects no function

Step 5

Exit Code 3. Return to Operational Display

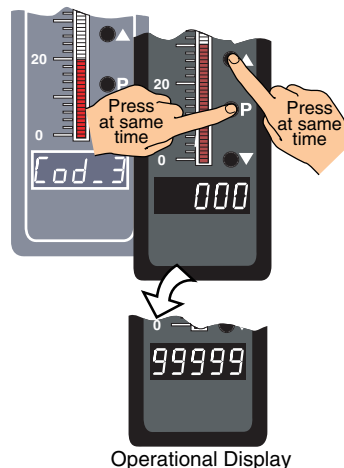

Step 4

Save setting and enter Code 3

Press

Use the buttons to set the required smart input module code (0 to 377). See I-Series Input Module Guide (Z87) for code details.

[Code 3] - Channel 1 Post Processing & Serial Mode Functions

Post processing functions refer to functions that occur to the input after it has been configured and scaled.

Post processing for Channel 1 (CH1) is configured in the first digit of Code 3. The diagram below lists the available post processing configuration selections in Code 3 (1st digit only).

| FIRST DIGIT | SECOND DIGIT | THIRD DIGIT |
|--|--|---|
| CODE 3 – CHANNEL 1 FUNCTIONS (POST PROCESSING & SERIAL MODE) | | |
| CH1 POST PROCESSING | 32-POINT LINEARIZATION FOR CHANNEL 1 | SERIAL MODE |
| 0 Direct Display of Input (no processing) 1 Square Root of Channel 1 2 Inverse of Channel 1 3 - | 0 No Linearization on CH1 1 32-point Linearization on CH1 using Table 1 2 32-point Linearization on CH1 using Table 2. See Note 5 3 32-point Linearization on CH1 using Table 3. See Note 5 4 32-point Linearization on CH1 using Table 4. See Note 5 5 125-point Linearization on CH1 (Tables 1 to 4 cascaded). See Note 5 6 32-point Linearization on CH1 (Tables 1 to 4 selected from the rear pins of selected input modules). The selected table is not available if CH2, CH3, or CH4 is operating in the analog output mode. CH1 must be set to Voltage, Current in Code 2 [X0X]. See Note 5 7 - | 0 ASCII Mode 1 Modbus Mode 2 Master mode (used to customize print mode protocols via macro) 3 Print Mode 4 Ethernet Mode. See Note 6 5 Devicenet Mode (no longer supported). |

Note 5:
If only 4 kB memory installed, functions 2 to 6 are not available in:

- Code 3 second digit.
- Code 4 third digit.
- Code 7 second digit.

Note 6:
These functions are not available on all models and in some cases require additional hardware.

START HERE

CONFIGURE CH1 POST PROCESSING FUNCTIONS

Step 1

Enter Brightness Mode

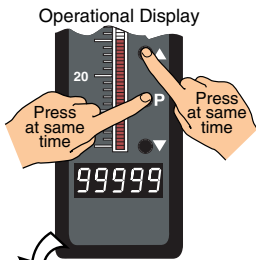

Step 2

Pass Brightness Mode, Calibration Mode, Codes 1 and 2, and enter Code 3

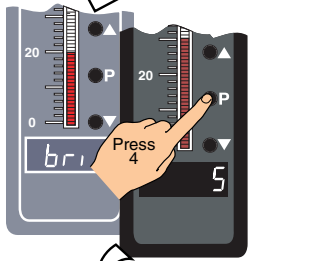

Step 3

Set Code 3 to [100]:
 1st Digit = 1 Square root of CH1
 2nd Digit = 0 No linearization
 3rd Digit = 0 ASCII Mode

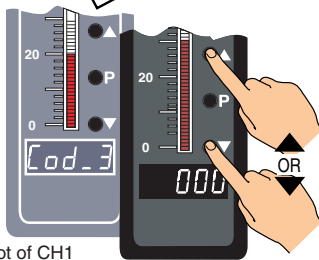

From Step 3

Step 4

Save Post Processing setting



Step 5

Exit Code 4. Return to Operational Display

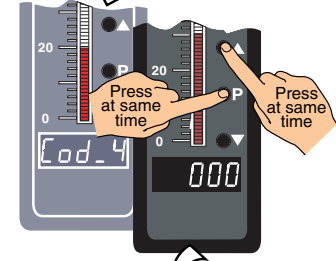

Operational Display

To Step 4



Programming tip

For full details on the Serial Mode, see *Serial Communications Output Module* supplement.

Print Mode – Data Printing Direct to Serial Printer

Print mode data logging is a simple method of capturing data using the meter's print mode. The data can be printed directly to a serial printer from the meter.

The print mode uses the meter's serial communications port to connect to a remote serial printer. The data can be printed with or without a Day: Month: Year or Hours: Minutes: Seconds time stamp.

Time stamp settings are configured in Code 8.

Print Mode – Data Printed Direct to PC

The print mode can also be used to print data to a PC where it is logged in a Windows Terminal program.

The print mode uses the meter's serial communications port to connect to the PC. The data can be logged with or without a Day: Month: Year or Hours: Minutes: Seconds time stamp.

Time stamp settings are configured in Code 8.

[CodE 4] - Channel 2 Measurement Task & Sampling Rate

Code 4 is a single code that combines all the configuration and post processing functions available for Channel 2.

When a **dual input** signal conditioner is installed, the second input signal is processed and displayed on CH2.

Measurement task and 32-point linearization for CH2 is configured in the 1st and 2nd digits of Code 4. The diagram opposite lists the available configuration selections in Code 4.

Example Procedure:

Configure CH2 for a direct voltage input with no linearization by setting Code 4 to [010].

| FIRST DIGIT | SECOND DIGIT | THIRD DIGIT |
|---|---|---|
| CODE 4 – CHANNEL 2 MEASUREMENT TASK AND 32-POINT LINEARIZATION | | |
| MEASUREMENT TASK | FOR VOLTAGE & CURRENT | 32-POINT LINEARIZATION FOR CH2 |
| 0 Voltage, Current | 0 Channel 2 Disabled | 0 No user defined Linearization on CH2 |
| 1 TC (type as per 2nd digit) | 1 Direct (no post processing) | 1 32-point Linearization on CH2 using Table 1 |
| 2 RTD (type as per 2nd digit) | 2 Square Root of Channel 2 | 2 32-point Linearization on CH2 using Table 2. See Note 5 |
| 3 Second Digital Input Channel (type as per 2nd digit) | 3 Inverse of Channel 2 | 3 32-point Linearization on CH2 using Table 3. See Note 5 |
| | 4 Output Register 1 (smart module) | 4 32-point Linearization on CH2 using Table 4. See Note 5 |
| | 5 Output Register 2 (smart module) | 5 125-point Linearization on CH2 (Tables 1 to 4 cascaded). See Note 5 |
| | 6 Output Register 3 (smart module) | 6 – |
| | 7 Output Register 4 (smart module) | 7 – |
| | FOR THERMOCOUPLE | |
| | 0 Type J | |
| | 1 Type K | |
| | 2 Type R | |
| | 3 Type S | |
| | 4 Type T | |
| | 5 Type B | |
| | 6 Type N | |
| | 7 Select user defined table set up in CAL [24X] | |
| | FOR RTD TYPE (3-WIRE) | |
| | 0 Resistance | |
| | 1 RTD 385 | |
| | 2 RTD 392 | |
| | 3 RTD 120 | |
| | 4 Cn10 | |
| | DIGITAL INPUT | |
| | 0 Frequency - 99.999 Hz range from 0.01 Hz | |
| | 1 Frequency - 999.99 Hz range from 0.01 Hz | |
| | 2 Frequency - 99.999 kHz range from 1 Hz (1 s gate) | |
| | 3 Frequency - 500 kHz range from 10 Hz (0.1 s gate) | |
| | 4 Period - 9.9999 s (100 μs resolution) | |
| | 5 Period - 999.99 ms (10 μs resolution) | |
| | 6 Up/Down Counter with Prescaler | |
| | 7 Set Prescaler | |

Note 5:
If only 4 kB memory installed, functions 2 to 6 are not available in:
• Code 3 second digit.
• Code 4 third digit.
• Code 7 second digit.

See *I-Series Input Modules Guide (Z87)* for procedures to set up a dual input module.

START HERE

CONFIGURE CH2 MEASUREMENT TASK

Step 1

Enter Brightness Mode

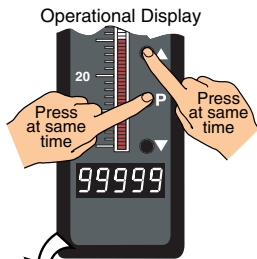

Step 2

Pass Brightness Mode, Calibration Mode, and Codes 1 to 3, and enter Code 4

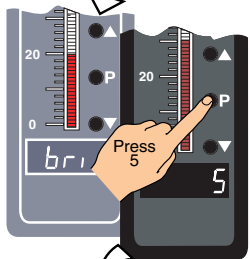

Step 3

Set Code 4 to [030]:
1st Digit = 0 Selects voltage, current
2nd Digit = 1 Selects direct
3rd Digit = 0 Selects no linearization

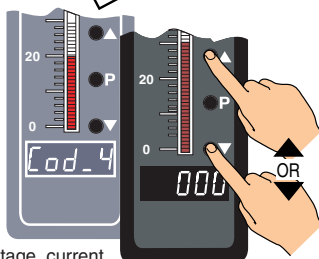

From Step 3

Step 4

Save CH 2 Measurement Task setting



Step 5

Exit Code 5. Return to Operational Display

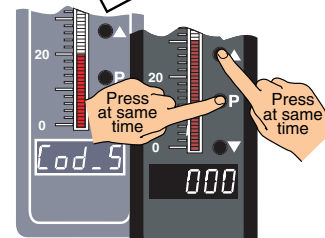

PRE_S

Use buttons to set prescale values from 1 to 65535 counts

[Code 5] - Channel 3 Functions

Code 5 is a single code that combines all the configuration and post processing functions available for Channel 3.

When a **triple input** signal conditioner is installed, the third input signal is processed and displayed on CH3.

Post processing and measurement task functions for CH3 are configured in the 1st, 2nd, and 3rd digits of Code 5. The diagram opposite lists the available configuration selections in Code 5.

Example Procedure:

Configure CH3 to display the square root of a voltage input by setting Code 5 to **[11X]**.

| FIRST DIGIT | SECOND DIGIT | THIRD DIGIT |
|--|--|---|
| CODE 5 - CHANNEL 3 FUNCTIONS | | |
| CH3 POST PROCESSING | MEASUREMENT TASK | FOR THERMOCOUPLE |
| 0 Direct Display of Input (no processing) | 0 No Function | 0 Type J |
| 1 Square Root of Channel 3 | 1 Voltage / current | 1 Type K |
| 2 Inverse of Channel 3 | 2 TC (3rd digit selects type of TC) | 2 Type R |
| 3 4 kB Meters 32-point Linearization of CH3 using Table 1 | 3 RTD (3rd digit selects type of RTD) | 3 Type S |
| 32 kB Meters 32-point Linearization of CH3 using Table 3 | 4 Real Time Clock & Timer (3rd digit selects type) | 4 Type T |
| <i>Note:</i> All linearization tables are set up in the Calibration Mode [24X]. | 5 - | 5 Type B |
| | 6 - | 6 Type N |
| | 7 Smart Input Module (3rd digit selects register) | 7 Select user defined linearization table (Table 1) set up in CAL [24X] |
| | | FOR RTD TYPE (2-, 3-, 4- WIRE) |
| | | 0 Resistance |
| | | 1 RTD 385 |
| | | 2 RTD 392 |
| | | 3 RTD 120 |
| | | 4 Cn 10 |
| | | FOR REAL-TIME CLOCK & TIMER |
| | | 0 HRS:MIN:SEC |
| | | 1 HRS:MIN |
| | | 2 - |
| | | 3 - |
| | | 4 1 Second Count UP Timer |
| | | 5 1 Second Count DOWN Timer |
| | | 6 - |
| | | 7 - |
| | | FOR SMART INPUT MODULE |
| | | 0 Output Register 1 |
| | | 1 Output Register 2 |
| | | 2 Output Register 3 |
| | | 3 Output Register 4 |
| | | 4 Output Register 5 |
| | | 5 Output Register 6 |
| | | 6 Output Register 7 |
| | | 7 Smart Input Module Register 2 Code Setup |

See **I-Series Input Modules Guide (Z87)** for procedures to set up a triple input module.

START HERE

CONFIGURE CH3 FUNCTIONS

Step 1

Enter Brightness Mode

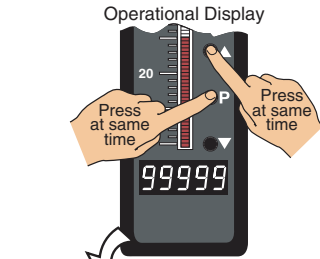

Step 2

Pass Brightness Mode, Calibration Mode, and Codes 1 to 4 and enter Code 5

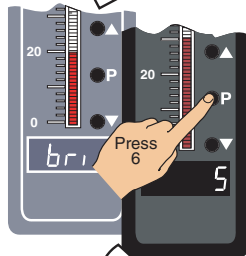

Step 3

Set Code 5 to [11X]:
1st Digit = 1 Selects square root of CH3
2nd Digit = 1 Selects voltage, current
3rd Digit = X Not relevant

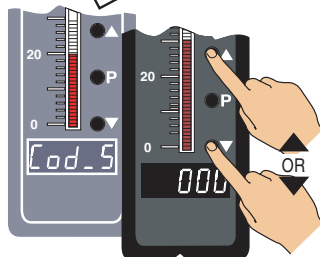

Step 4

Save CH3 setting

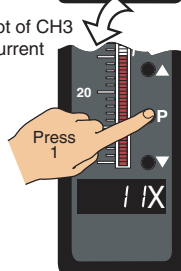

Press **P 577rE 000** Use the **↑↓** buttons to set the required smart input module code (0 to 377). See **I-Series Input Modules Guide (Z87)** for code details.

Step 5

Exit Code 6. Return to Operational Display

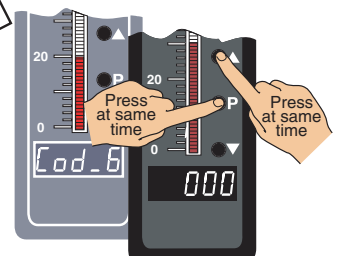

[CodE 6] - Channel 4 Functions

Code 6 is a single code that combines all the configuration and post processing functions available for Channel 4.

When a **quad input** signal conditioner is installed, the fourth input signal is processed and displayed on CH4.

Post processing and measurement task functions for CH4 are configured in the 1st, 2nd, and 3rd digits of Code 6. The diagram opposite lists the available configuration selections in Code 6.

Example Procedure:

Configure CH4 as direct display of voltage input by setting Code 6 to [01X].

| FIRST DIGIT | SECOND DIGIT | THIRD DIGIT |
|---|--|---|
| CODE 6 – CHANNEL 4 FUNCTIONS | | |
| CH4 POST PROCESSING 0 Direct Display of Input (no processing) 1 Square Root of Channel 4 2 Inverse of Channel 4 3 4 kB Meters 32-point Linearization of CH4 using Table 1 32 kB Meters 32-point Linearization of CH4 using Table 4 Note: All linearization tables are set up in the Calibration Mode [24X]. | MEASUREMENT TASK 0 No Function 1 Voltage / Current 2 TC (3rd digit selects type of TC). See Note 7 3 RTD (3rd digit selects type of RTD). See Note 7 4 Real Time Clock and Timer (3rd digit selects type) 5 - 6 - 7 Smart Input Module (3rd digit selects register) | FOR THERMOCOUPLE 0 Type J 1 Type K 2 Type R 3 Type S 4 Type T 5 Type B 6 Type N 7 Select user defined linearization table (Table 1) set up in CAL [24X] FOR RTD TYPE (2-, 3-, 4- WIRE) 0 Resistance 1 RTD 385 2 RTD 392 3 RTD 120 4 Cn 10 FOR REAL-TIME CLOCK & TIMER 0 HRS:MIN:SEC 1 HRS:MIN 2 - 3 - 4 1 Second Count UP Timer 5 1 Second Count DOWN Timer 6 - 7 - FOR SMART INPUT MODULE 0 Output Register 1 1 Output Register 2 2 Output Register 3 3 Output Register 4 4 Output Register 5 5 Output Register 6 6 Output Register 7 7 Smart Input Module Register 3 Code Setup |

Note: 7
For future development.

See I-Series Input Modules Guide (Z87) for procedures to set up a quad input module.

START HERE

CONFIGURE CH4 FUNCTIONS

Step 1

Enter Brightness Mode

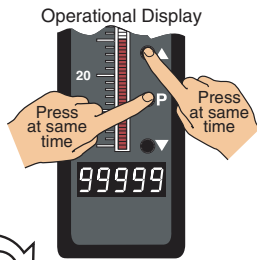

Step 2

Pass Brightness Mode, Calibration Mode, and Codes 1 to 5 and enter Code 6

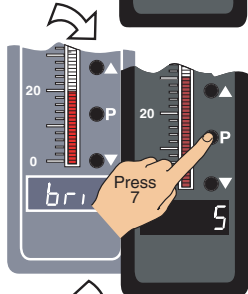

Step 3

Set Code 6 to [01X]:
 1st Digit = 0 Selects direct display of CH4 processed signal
 2nd Digit = 1 Selects voltage, current
 3rd Digit = X Not relevant

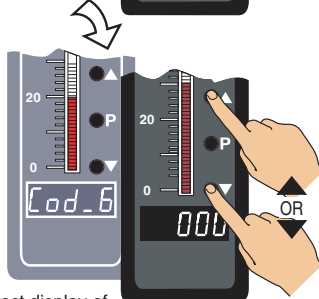

Step 4

Save CH4 setting



Step 5

Exit Code 7. Return to Operational Display

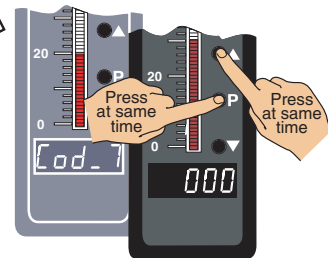

To Step 5



Press **P** `Smart` `000` Use the **↑** **↓** buttons to set the required smart input module code (0 to 377). See I-Series Input Modules Guide (Z87) for code details.

The third digit of Code 7 performs various math functions between channel 1 and channel 2 and stores this data in the result register.

The data in the result register can then be further processed by the selections made in the 1st and 2nd digits.

| FIRST DIGIT | SECOND DIGIT | THIRD DIGIT |
|--|---|------------------------------------|
| CODE 7 – RESULT PROCESSING | | |
| RESULT PROCESSING | 32-POINT LINEARIZATION FOR RESULT | MATH FUNCTIONS FOR RESULT |
| 0 Direct Display of Result as per processing performed in 2nd or 3rd digit | 0 No Linearization on Result | 0 Result Register not Updated |
| 1 Square Root of Result | 1 32-point Linearization on Result using Table 1 | 1 pH Meter (CH1 = Tbuff, CH2 = pH) |
| 2 Inverse of Result | 2 32-point Linearization on Result using Table 2. See Note 5 | 2 Result = CH1, Setpoint 2 = CH2 |
| 3 - | 3 32-point Linearization on Result using Table 3. See Note 5 | 3 Result = CH1 + CH2 |
| | 4 32-point Linearization on Result using Table 4. See Note 5 | 4 Result = CH1 - CH2 |
| | 5 125-point Linearization on Result (Tables 1 to 4 cascaded). See Note 5 | 5 Result = (CH1 x 20 000)/CH2 |
| | 6 32-point Linearization on Result (Tables 1 to 4 selected from the rear of the meter). The selected table is not available if CH2, CH3, or CH4 is operating in the analog mode. CH1 must be set to Voltage, Current in Code 2 [X0X]. See Note 5 | 6 Result = CH1 x CH2/10 000 |
| | 7 - | 7 Result = CH1 |

Example Procedure:

Configure Code 7 to add the input of CH1 and CH2 and directly display the result by setting Code 7 to [003].

Note 5:
If only 4 kB memory installed, functions 2 to 6 are not available in:

- Code 3 second digit.
- Code 4 third digit.
- Code 7 second digit.

See I-Series Input Modules Guide (Z87) for procedures to set up a dual, triple, or quad input module.

Linearization Table Notes

A base meter with 4 kB memory installed has a single 32-point programmable linearization table available.

For four 32-point programmable linearization tables to be available, the meter requires at least 32 kB of memory to be installed.

Meters with 4 kB Memory

In base meters with 4 kB memory, set up Table 1 in the Calibration Mode to [24X]. This means that Table 1 is available to be applied to:

- CH1 – Selected in Code 3.
- CH2 – Selected in Code 4.
- CH3 – Selected in Code 5.
- CH4 – Selected in Code 6.

Meters with 32 kB Memory

In base meters with 32 kB or more memory, each of the four tables (Tables 1 to 4) are set up in [24X] of the Calibration Mode by selecting the appropriate table number. This means that the four tables are available for the four channels as follows:

- CH1 – All four tables selected in Code 3.
- CH2 – All four tables selected in Code 4.
- CH3 – Table 3 selected in Code 5.
- CH4 – Table 4 selected in Code 6.

START HERE

CONFIGURE RESULT PROCESSING

Step 1

Enter Brightness Mode

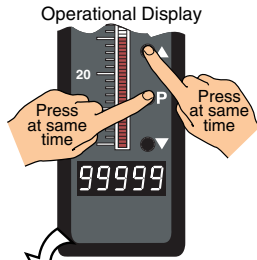

Step 2

Pass Brightness Mode, Calibration Mode, and Codes 1 to 6 and enter Code 7

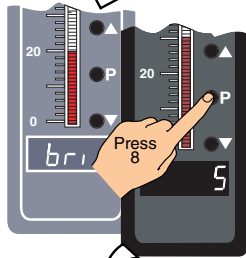

Step 3

Set Code 7 to [003]:
1st Digit = 0 Selects direct display of result
2nd Digit = 0 Selects no linearization on result
3rd Digit = 3 Selects result = CH1+CH2

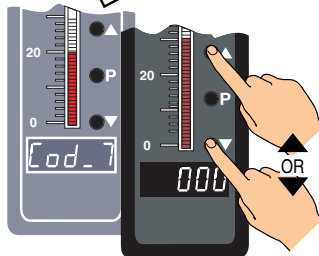

Step 4

Save CH1 & CH2 Result Processing setting



Step 5

Exit Code 8. Return to Operational Display

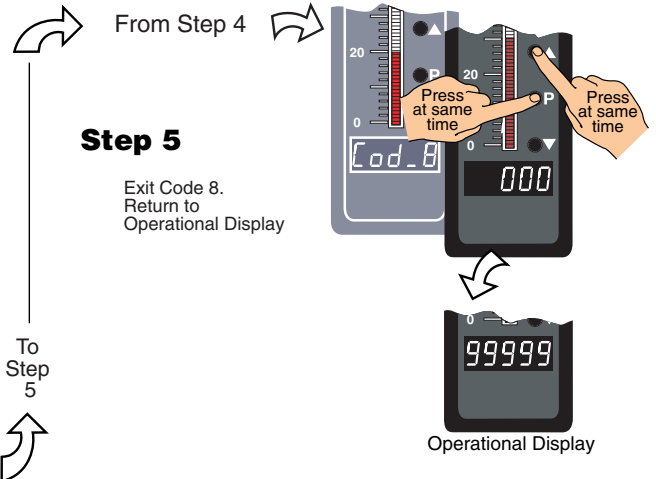

[Code 8] - Data Logging & Print Mode

Up to 4000 samples can be logged within the meter in the cyclic or linear FIFO mode and saved for later downloading to a PC, using a terminal emulation program, or printing directly to a serial printer.

Data logging can be triggered (activated) from a setpoint, the program button, or from an external switch. See the 3rd digit in the diagram below.

Data from up to four selectable registers can be logged with one of the following printer or spreadsheet style time and date stamps. All time and date stamps are generated from an optional real-time clock (see the 2nd digit in the diagram below):

- No time stamp.
- Month - Day - Year. Hours:Minutes:Seconds.
- Day - Month - Year. Hours:Minutes:Seconds.
- Hours:Minutes:Seconds.

Printer style time and date stamps have a carriage return and line feed. Spreadsheet style time and date stamps are continuous on a single line.

See Serial Communications Module Supplement (NZ202) for full details on the Data Logging and Print Mode Options.

| FIRST DIGIT | SECOND DIGIT | THIRD DIGIT |
|---|---|---|
| CODE 8 – DATA LOGGING AND PRINT MODE OPTIONS | | |
| DATA LOG BUFFER TYPE | DATE & TIME STAMP OPTIONS | LOG & PRINT TRIGGER |
| 0 No Data Logging 1 Cyclic Buffer 2 Linear FIFO Buffer. 3 Reset Buffer Number to 0. <i>Note:</i> <i>Setting Code 8 to [3XX] resets the data log buffer to 0. Once reset, Code 8 must be set back to the required data log buffer setting.</i> | 0 Printer Format – No time stamp with print/log 1 Printer Format – Time stamp format 1 [Mth-Day-Yr Hrs:Min:Sec] (with <CR><LF>) 2 Printer Format – Time stamp format 2 [Day-Mth-Yr Hrs:Min:Sec] (with <CR><LF>) 3 Printer Format – Time stamp format 3 [Hrs:Min:Sec] (with <CR><LF>) 4 Spreadsheet Format – No time stamp with print/log 5 Spreadsheet Format – Time stamp format 1 [Mth-Day-Yr Hrs:Min:Sec] 6 Spreadsheet Format – Time stamp format 2 [Day-Mth-Yr Hrs:Min:Sec] 7 Spreadsheet Format – Time stamp format 3 [Hrs:Min:Sec] ALL ABOVE ARE REAL-TIME CLOCK OPTIONS | 0 No trigger 1 Trigger on Demand from PROGRAM Button 2 Trigger on Demand from F1 Button 3 Trigger on Demand from F2 Button 4 Trigger on Demand from HOLD Pin 5 Trigger on Demand from LOCK Pin 6 - 7 - <i>Note:</i> <i>Log and/or print will only trigger if enabled.</i> |

[Code 9] - Functions for Digital Input Pins

The TEST, HOLD, and LOCK pins are located at the rear of the meter to accommodate external switched digital inputs. When switched to the COMMON pin, they can be programmed in Code 9 to perform remote resetting functions to add to the functionality of the meter.

Note:

CAPTURE, HOLD, and LOCK pins can be a setpoint activation source. See Setpoint Programming mode.

| FIRST DIGIT | SECOND DIGIT | THIRD DIGIT |
|--|---|---|
| CODE 9 – FUNCTIONS FOR DIGITAL INPUT PINS | | |
| DISPLAY TEST PIN | HOLD PIN | LOCK PIN |
| 0 Display test only 1 Reset Counter Channel 1 and Sub-total at Power-up 2 Reset Counters Channel 1, 2, 3, 4, Total 1, and Total 2 at Power-up 3 Reset Total 1, and Total 2 at Power-up | 0 Display Hold 1 Reset Channel 1 2 Reset Total 1 and Total 2 3 Reset Total 2 4 Reset Peak, Valley 5 Reset Tare 6 Set Tare 7 Unlatch (de-energize) all Setpoints | 0 Key Lock 1 Reset Channel 1 2 Reset Channel 2 3 Reset Channel 3 4 Reset Channel 4 5 Reset Tare 6 Reset Total 7 Unlatch (de-energize) all Setpoints |

Setpoint Programming Mode

All setpoint activation and control settings are selected and configured using the front panel buttons in the **setpoint programming mode**. Or, software configured via the **meter configuration utility program** if the meter is connected to a PC through the serial port. The meter has six software driven setpoints, independently configured to operate within the total span range of the meter and the selected input module.

Setpoint Programming Mode

See the *Setpoint Programming Mode Logic Diagram* opposite.

The setpoint programming mode is entered by pressing the meter's **[P]** and **[↓]** buttons at the same time.

Setpoint Activation Values

Each setpoint activation value is individually programmed. Setpoint activation values can be set within the total span range of the meter and the selected input module.

Setpoint and Relay Control Settings

See the *Setpoint and Relay Control Settings* diagram on Pages 41 and 42.

The control settings provide access to the following setpoint and relay functions for configuration using the meter's 1st, 2nd, and 3rd digits:

- **1st Digit** – Relay Energize Functions.
- **2nd Digit** – Setpoint Activation Source.
- **3rd Digit** – Setpoint Delay, Timer, and Reset and Trigger Functions.

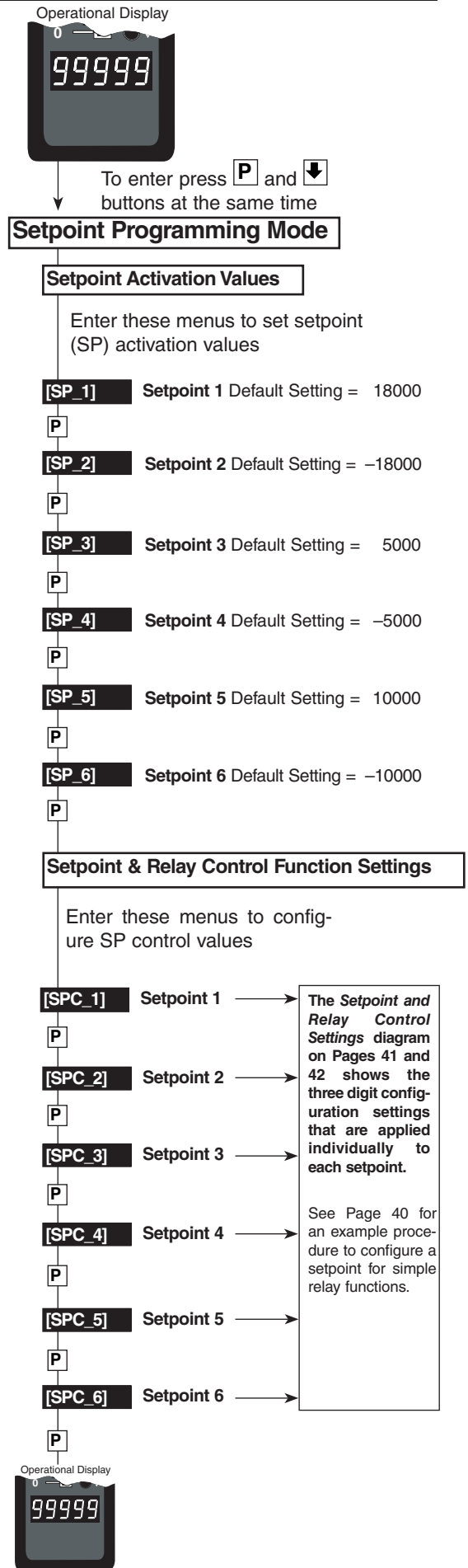

Setpoint Programming Mode Logic Diagram

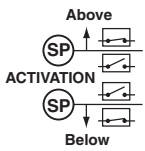

Relay Energize Functions

All setpoints activate at the setpoint value. All relays/setpoints are programmable to energize above or below the setpoint value.

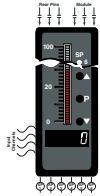

Setpoint Activation Source

Setpoints activate from any input channel, selected meter register, or external switched inputs (digital input pins).

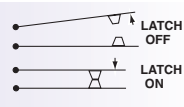

Setpoint Latching

Setpoints can be programmed in relay latching modes.

TRIGGER OPERATES ON:

- MAKE EDGE
- BREAK EDGE
- MAKE & BREAK EDGE
- EVERY SAMPLE PERIOD

RESET SELECTED REGISTER

TRIGGER PRINT

TRIGGER LOG DATA



Setpoint Reset & Trigger

Setpoints can be programmed to reset selected registers, or be manually reset. They can also trigger a data print or a data log.



Setpoint Tracking

Setpoint tracking can be applied to setpoints configured in the hysteresis, deviation, or PID modes.

Display Flashing

Display flashing can be applied to setpoints configured in the hysteresis or deviation modes.

Each setpoint can be programmed to make the display flash on and off while the setpoint is active, and keep it flashing until the setpoint de-activates.

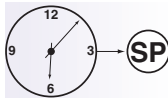

Real-time Clock Option

Any setpoint can be programmed to operate from the real-time clock option.

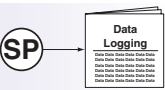

Data Logging

Any setpoint can be programmed to log data within the meter (up to 4000 samples).

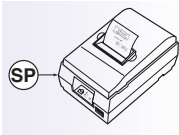

Data Printing to Serial Printer

Any setpoint can be programmed to send data directly to a serial printer.

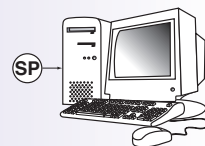

Data Printing to PC

Any setpoint can be programmed to send data directly to a connected PC.



Hysteresis or Deviation

Each relay can operate in a hysteresis or deviation mode.

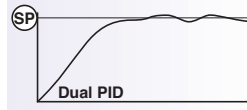

PID Control Settings

The PID (proportional, integral, derivative) control function provides exceptional control stability during control process applica-

tions. PID control is available from the following outputs:

- Setpoint / relay output.
- Analog output.
- Relay and analog output at the same time.

PID control from the setpoint / relay output is available from SP1 and SP2 only.

There are two PID control outputs available via the analog output:

- PID1 – stored in register 50.
- PID2 – stored in register 51.

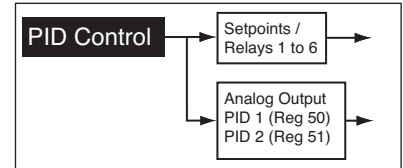

Timer Modes

Each setpoint can be programmed to operate the relay in one of the following seven resident timer modes:

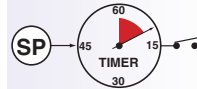

Normal Mode Timer

Single actuation, delay-on-make (DOM) and delay-on-break (DOB).

Normally OFF/Pulsed ON Timers

Repeat ON Mode Timer – multiple actuation, programmable off- and on-time.

Pulse ON Mode Timer – single actuation, programmable DOM and maximum on-time.

1-Shot ON Mode Timer – single actuation, programmable DOM and minimum on-time.

Normally ON/Pulsed OFF Timers

Repeat OFF Mode Timer – multiple actuation, programmable off- and on-time.

Pulse OFF Mode Timer – single actuation, programmable DOB and maximum off-time.

1-Shot OFF Mode Timer – single actuation, programmable DOB and minimum off-time.

Hysteresis or Deviation

Each setpoint can be individually programmed to energize the relay in the hysteresis or deviation mode, with or without initial startup inhibit.

Hysteresis (deadband) is the programmable band above and below the setpoint value that determines when and for how long the relay is energized or de-energized. The setpoint can be programmed to energize the relay above or below the setpoint value.

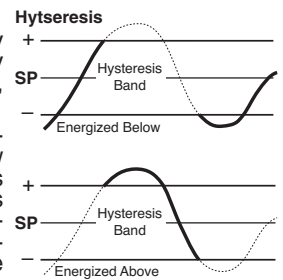

The hysteresis setting can be any value between 0 and 65535 counts. The number of counts selected act both positively and negatively on the setpoint, forming a hysteresis band around the setpoint.

For example, if the setpoint setting is 500 counts and the hysteresis setting is 10 counts, the hysteresis band around the setpoint setting is 20 counts, starting at 490 counts and ending at 510 counts.

Note:

If hysteresis is set with ZERO counts, the relay energizes AT or ABOVE the setpoint value.

Setpoint Programming Mode continued

Deviation (passband) is the programmable band around the setpoint in which the setpoint can be programmed to energize the relay inside or outside the deviation band.

The deviation setting can be any value between 1 and 65535 counts. The number of counts selected act both positively and negatively on the setpoint, forming a deviation band around the setpoint.

For example, if the setpoint setting is 1000 counts and the deviation setting is 35 counts, the deviation band around the setpoint setting is 70 counts starting at 965 counts and ending at 1035 counts.

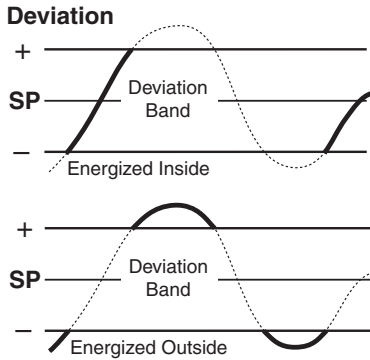

Initial Start-up Inhibit.

On power-on, start-up inhibit prevents the relay from energizing on the first setpoint activation cycle. Depending on how the meter has been programmed, initial start-up inhibit either functions during a falling input signal, or during a rising input signal.

Relay Time Control Modes

The following time control mode settings can cover almost every relay timer application.

All setpoints can be individually programmed to operate a relay in one of the following time control modes above or below the setpoint value.

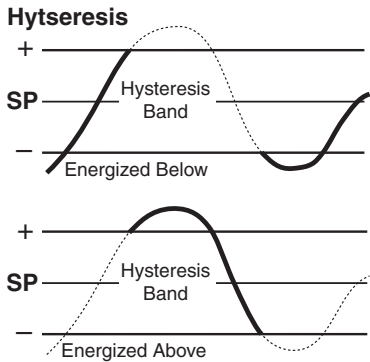

Normal Mode

This mode individually programs a relay's setpoint with delay-on-make (DOM) and delay-on-break (DOB) settings.

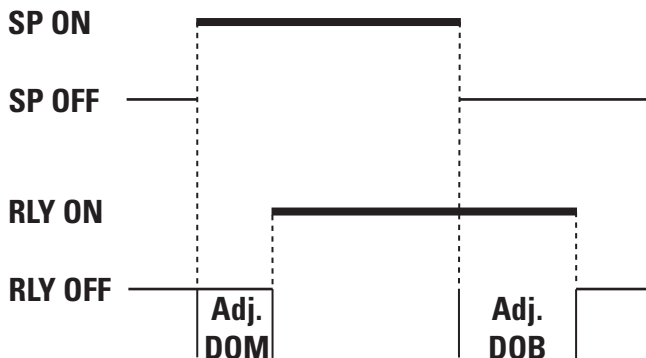

Normally OFF / Pulsed ON Modes

These are delay modes where the relay is normally off and pulses on when the setpoint activates.

Repeat ON Mode

Multiple actuation, programmable on and off time settings.

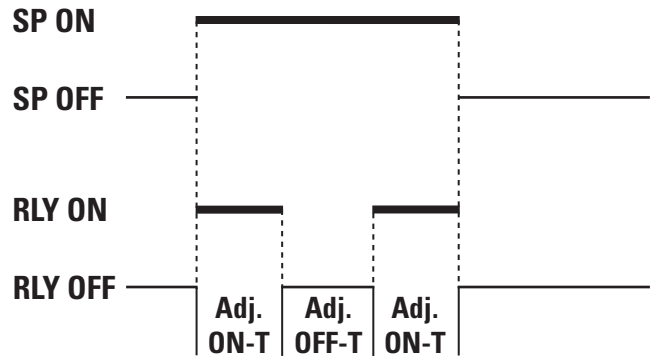

Pulse ON mode (Programmable ON-time)

Single actuation, programmable DOM and on time settings.

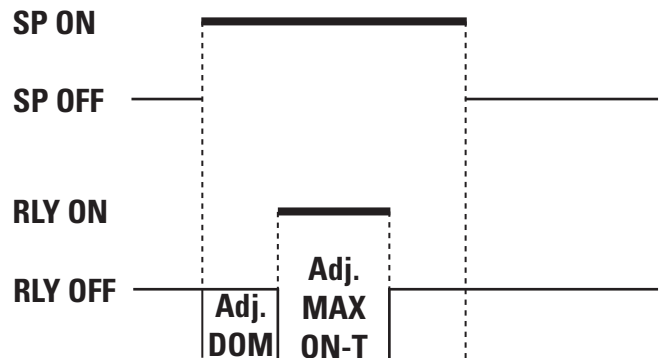

1-Shot ON mode (Programmable Minimum ON-time)

Single actuation, programmable DOM and minimum on time settings.

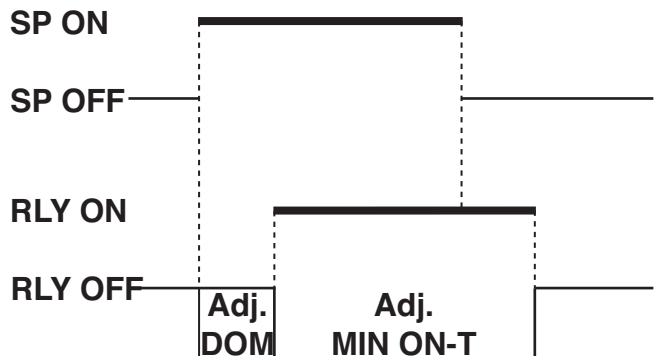

Normally ON / Pulsed OFF Modes

These are delay modes where the relay is **normally on** and **pulses off** when the setpoint activates.

1-Shot OFF mode (Programmable Minimum OFF-time)

Single actuation, programmable **minimum off time** and **DOB** settings.

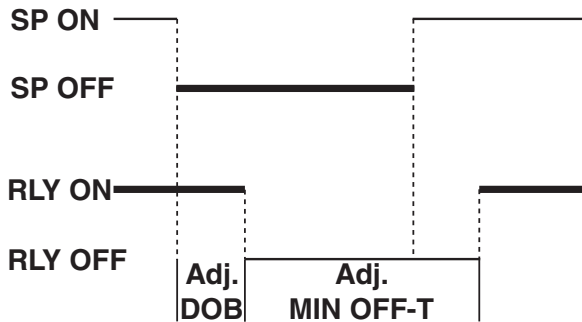

Pulse OFF mode (Programmable OFF-time)

Single actuation, programmable **off time** and **DOB**.

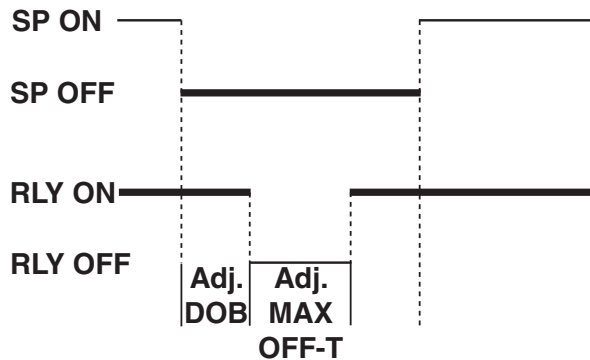

Repeat OFF Mode

Multiple actuation, programmable **off** and **on time** settings.

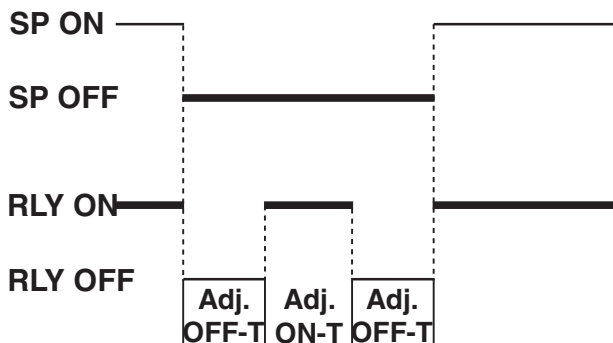

Each setpoint can be individually configured for basic to advanced operations in the following three levels. Each operational level is designed to provide only the required relevant setpoint and relay functions.

The modes at Level 2 and Level 3 can be set to OFF for each individual setpoint, ensuring that no other functions are programmed to influence the setup.

Level 1 Setpoint & Relay Basic Mode

This is an easily programmable mode for users who require the following basic setpoint and relay functions:

First Digit – Relay Energize Functions

Relays programmed to energize above or below the setpoint value.

Second Digit – SP Activation Source

Setpoints programmed to activate from selectable meter registers or one of six external switched inputs.

Third Digit – Setpoint Latching

Relays programmed with latching and manual reset options.

Level 2 Setpoint & Relay Intermediate Mode

Level 2 uses all Level 1 functions and is further extended by the following programmable modes. The functionality of the relay energize functions are extended by allowing the relays to be programmed with or without initial start-up inhibit.

Hysteresis, Deviation & PID Mode

This mode adds extra functionality to the basic mode by providing programmable hysteresis or deviation settings for all setpoints, or PID control from setpoints SP1 and SP2.

Timer Modes

These modes add even more functionality to the basic and intermediate mode by providing each setpoint with a choice of one of seven resident programmable timers.

Level 3 Setpoint & Relay Advanced Mode

Level 3 uses all Level 1 and Level 2 functions combined with reset and trigger functions to provide an extremely powerful advanced mode.

Level 3 enables you to program all setpoints individually for operations normally requiring sophisticated controllers.

Level 1 - Basic Mode - Programming Procedures

Example Procedure:

The following procedure describes how to program setpoint 1 (SP1) for the following **Level 1** setpoint and relay functions:

- SP1 to activate from Channel 1 (CH1).
- Relay to energize above or below SP1 value.
- Relay to latch with manual relay reset.

See *Setpoints and Relays Supplement (NZ201)* for procedures to program all setpoint and relay operational levels (Level 1 to Level 3).

START HERE

CONFIGURE LEVEL 1 SETPOINT & RELAY FUNCTIONS

Step 1

Enter Setpoint Programming Mode

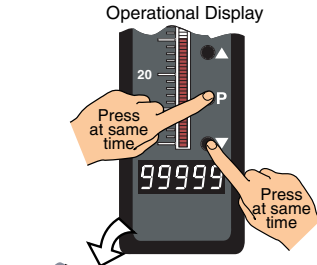

Step 2

Adjust setpoint 1 (SP1) activation value to e.g. 500 counts

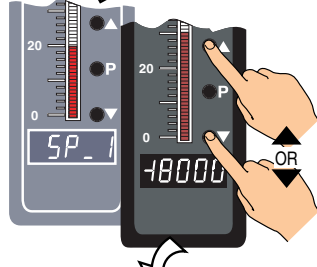

Step 3

Save SP1 activation value setting

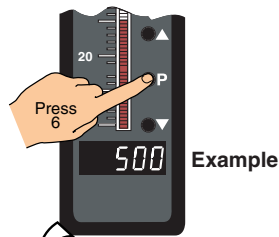

Step 4

Set SPC_1 to [013]:
 1st Digit = 0 Energize above SP1 value
 or 1 to energize below SP1 value
 2nd Digit = 1 Select source for SP1
 3rd Digit = 3 Relay latching with manual reset

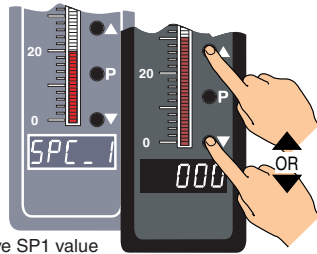

Step 5

Enter SP1 source sub-menu

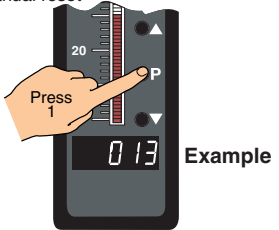

From Step 5

Step 6

Select [CH1] as the SP1 activation source. See diagram on Pages 28 and 29

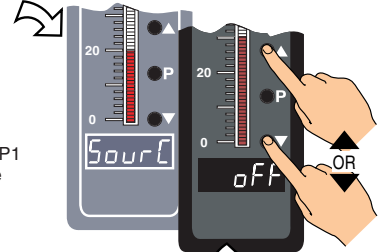

Step 7

Save SP1 control settings

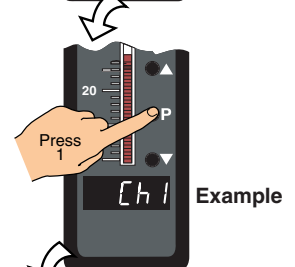

Step 8

Reset 2nd digit to 0. If the 2nd digit is not reset to 0, the meter will constantly cycle thru SPC_1.

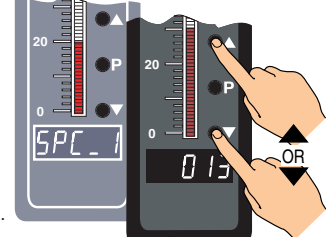

Step 9

Save SP1 control settings

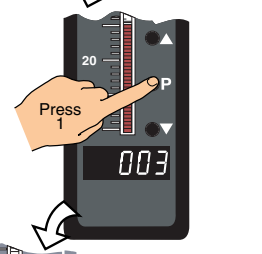

Step 10

Exit SPC_2. Return to Operational Display

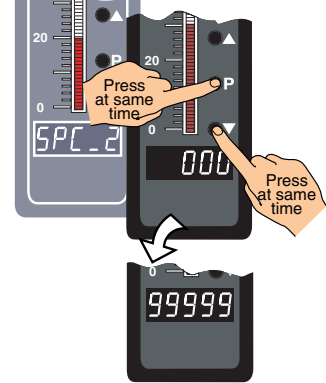

Operational Display



Programming tip

All required setpoint activation values (SP1 to SP6) can be adjusted before programming setpoint and relay control function settings. See *Setpoint Programming Mode Logic Diagram* on Page 41.

Setpoint & Relay Control Settings Diagram

The diagram below and continued on Page 42 shows the 1st, 2nd, and 3rd digit control settings for the setpoints and relays.

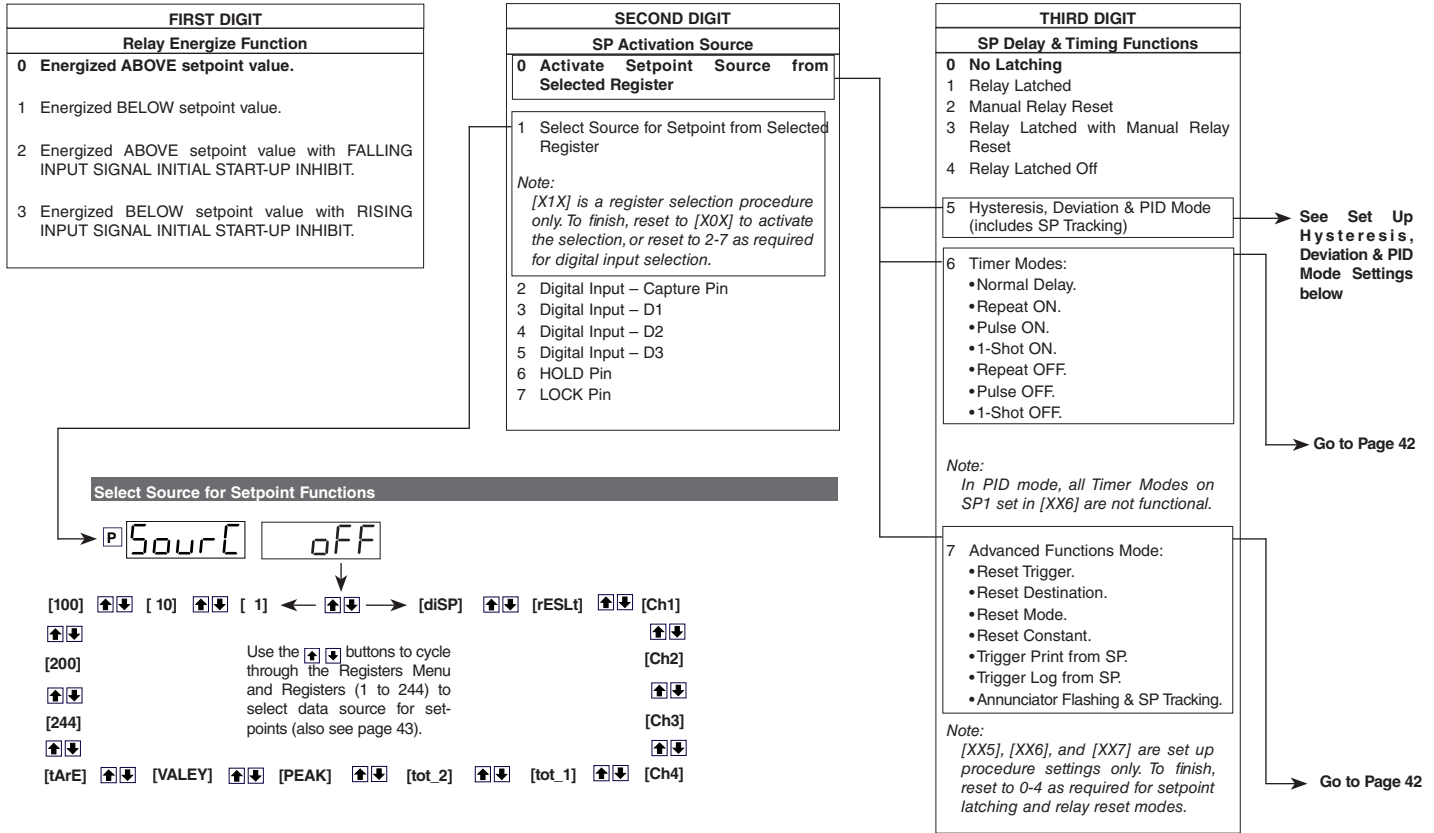

Set Up Hysteresis, Deviation & PID Mode Settings



Programming Tip

If you do not require any of the functions in this mode, ensure it is set to:

mode [off]

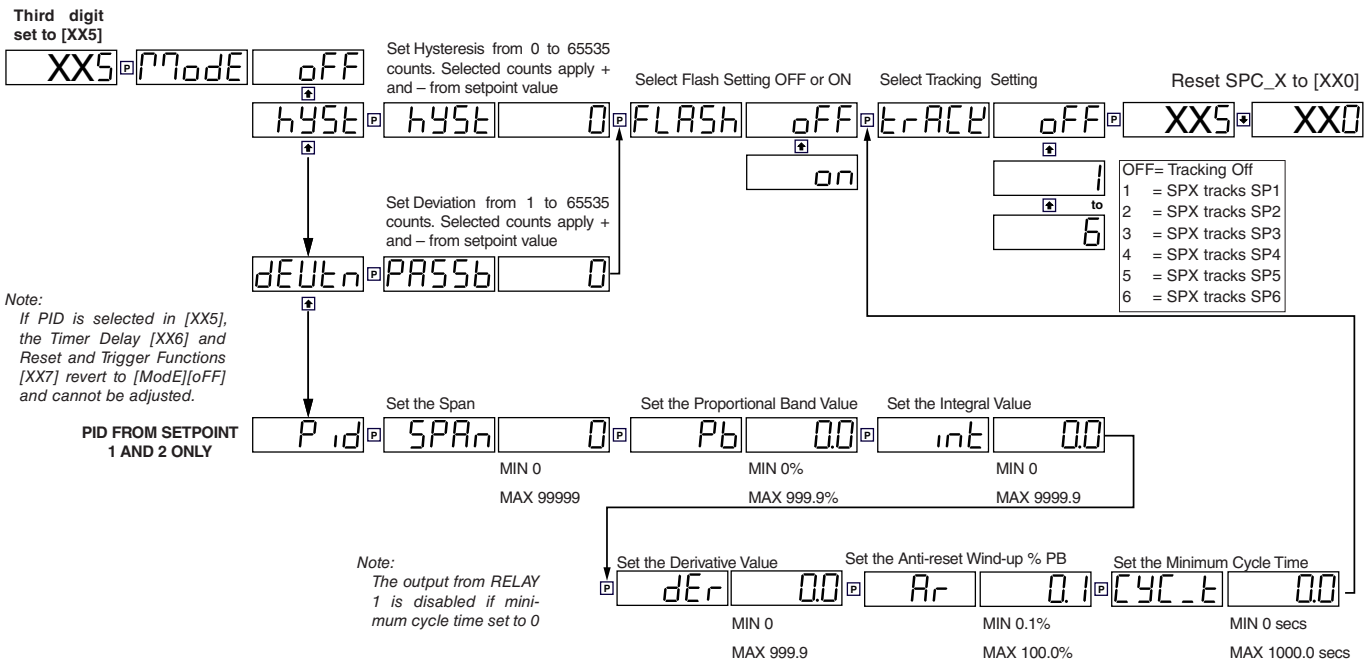

Setpoint Programming Mode continued

Set Up Timer Delay Settings



Programming Tip

If you do not require any of the functions in this mode, ensure it is set to:

trig OFF

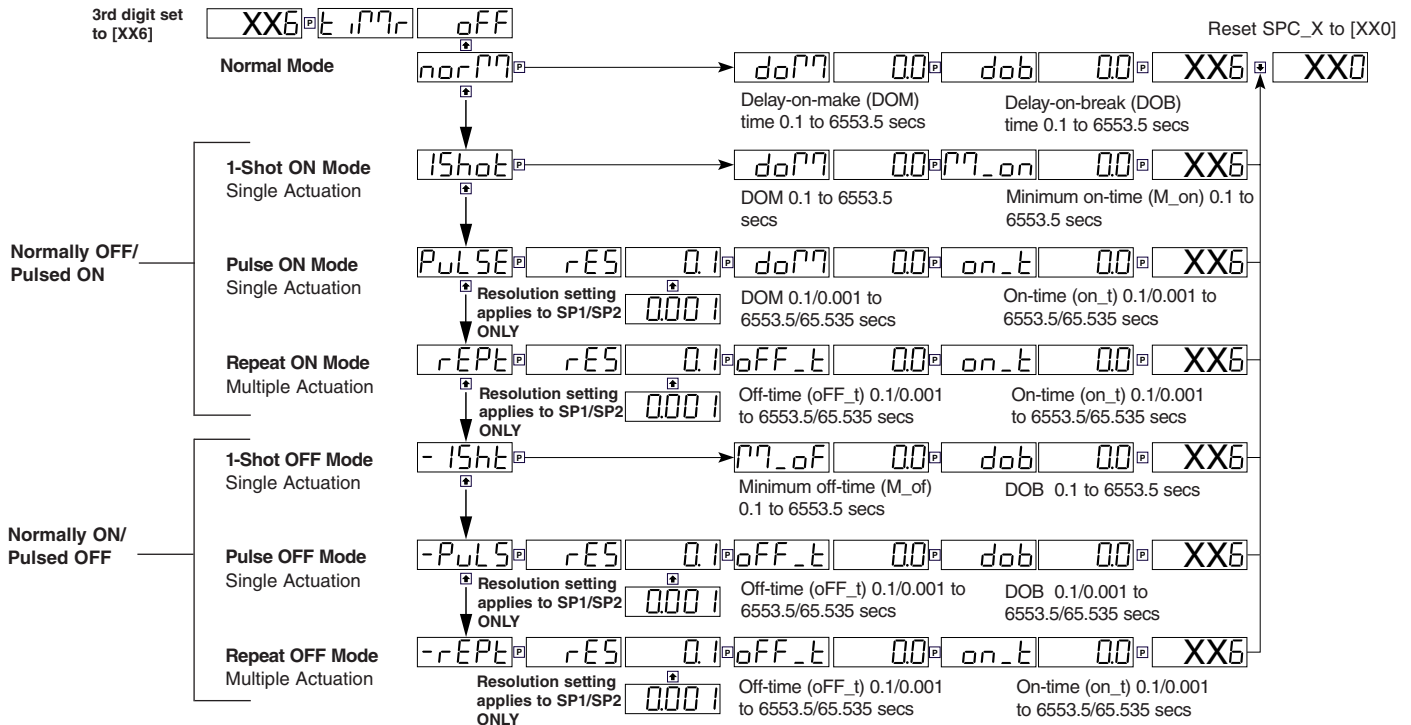

Set Up Register Reset and Setpoint Trigger Functions

Third digit set to [XX7]

Select Trigger Setting

[XX7] [trig] [OFF]

Select Reset Destination Register: [norm] [dest] [OFF]

Selecting [OFF] in the Destination Register Reset Setup takes you to Setpoint Print Trigger Setup

Select Print Triggered by Setpoint

[Print] [OFF] [on]

Select Log Triggered by Setpoint

[Log] [OFF] [on]

Reset SPC_X to [XX0]

- [brEAK] [244 to 1] [diSP]
 - [both] [tArE] [rESLt]
 - [LEVEL] [VALEy] [Ch1]
 - [PEAK] [tot_2] [Ch2]
 - [tot_1] [Ch3]
 - [Ch4]
- Use the [up] and [down] buttons to cycle through the Registers Menu and Registers (1 to 244) to select which destination register is to be reset by a setpoint (also see page 43).
- Use the [left] and [right] buttons to cycle through the options

Select Reset Mode: [mode] [const] [RES_C] [0]

Selecting any destination register takes you to Mode Reset

- [I-S+C]
- [d+C]
- [rEG]

Select Reset Constant

- Sets from 0 to -19999
- Sets from 0 to 99999

Select [rEG] to access the source parameter to select the number of the Modbus register in the meter to be copied to the reset destination register

- [244 to 1] [diSP]
 - [tArE] [rESLt]
 - [VALEy] [Ch1]
 - [PEAK] [Ch2]
 - [tot_2] [Ch3]
 - [tot_1] [Ch4]
- Use the [up] and [down] buttons to cycle through the Registers Menu and Registers (1 to 244) to select which register's contents are to be copied into the destination register by a setpoint (also see page 43).



Programming Tip

If you do not require any of the functions in this mode, ensure it is set to:

trig OFF

Registers That Can Be Selected By Front Panel Push Button Programming

A Tiger 320 Series meter has 6,144 registers which are provided for use by the operating system and the powerful Custom Macro Programming system.

40 Manually Selectable Registers

Using the front panel buttons, there are 40 registers that may be selected for use within the following functions:

- **[CodE_1] - Display Configuration [X50]**. Selection of a register as the data source for displays, peak and valley, totalizers and analog outputs. (See pages 20 & 22)
- **Setpoint Control Settings [X1X]**. Selection of a register as the data source for a setpoint. (See Page 41)
- **Setpoint Control Settings [XX7]**. Selection of a destination register that is to be reset by a setpoint with the contents of a selected source register. (See Page 42)
- **Setpoint Control Settings [XX7]**. Select which register's contents are to be copied into the destination register by a setpoint. (See Page 42)

The 40 registers that can be selected as a data source, a reset source or a reset destination for the functions above are shown in the table on the right.

The table shows, in seven columns, the functions where these registers can be used.

Where a register is more likely to be used in a particular function, a closed circle ● is shown in the column. For those functions where a register is less likely to be used, an open circle ° is shown.

No register number is shown for the first 11 functions, because these 11 functions are identified in the display menu for direct selection by their code names.

When cycling through the Registers Menu and then Registers 1 to 244, the numerical Register Set will increment through each decade in turn, from 1 to 0, while the button is held down. When [200] is reached, [oFF] or [tArE] will be displayed. To select a specific number set, the button should be released and pressed again each time the left most decade displays the desired number for that decade.

To quickly exit the numerical 1 to 244 Register Set, hold the [P] button down while cycling through the decades, and release it when [oFF] or [tArE] appears.

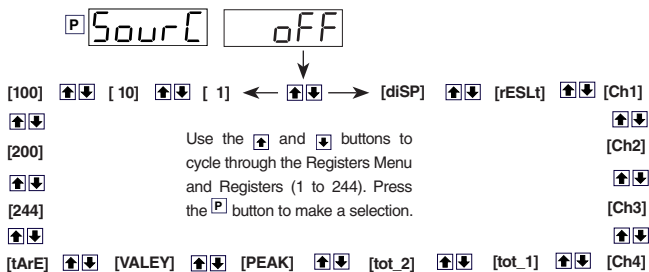

Registers that Should Not be Used

The following registers are contained within the selectable 1 to 244 Register Set, but they should not be selected because they are either reserved for future use, or for use by the operating system only:

15, 38, 47-48, 52-53, 61-64, 123-128, 140-141, 234-244

Any selection of these Registers may cause a malfunction.

| Register Functions | Register Numbers | Data Source for Displays | Data Source for Peak & Valley | Data Source for Analog Outputs 1 & 2 | Data Source for Totalizers 1 & 2 | Data Source for Setpoints | Reset Source | Reset Dest. |
|----------------------|------------------|--------------------------|-------------------------------|--------------------------------------|----------------------------------|---------------------------|--------------|-------------|
| Display [diSP] | - | | ● | ● | ● | ● | | |
| Result [rESLt] | - | ● | ● | ● | ● | ● | ● | ● |
| CH1 [Ch1] | - | ● | ● | ● | ● | ● | ● | ● |
| CH2 [Ch2] | - | ● | ● | ● | ● | ● | ● | ● |
| CH3 [Ch3] | - | ● | ● | ● | ● | ● | ● | ● |
| CH4 [Ch4] | - | ● | ● | ● | ● | ● | ● | ● |
| Total 1 [tot_1] | - | ● | ● | ● | | ● | ● | ● |
| Total 2 [tot_2] | - | ● | ● | ● | | ● | ● | ● |
| Peak [PEAK] | - | ° | | | | ● | ° | ● |
| Valley [VALEY] | - | ° | | | | ● | ° | ● |
| Tare [tArE] | - | ° | ° | ° | | | ° | ● |
| PID Output 1 | 50 | ° | ° | ° | | ° | | |
| PID Output 2 | 51 | ° | ° | ° | | ° | | |
| Smart Result 1 | 54 | ° | ° | ° | | | | ° |
| Smart Result 2 | 55 | ° | ° | ° | | | | ° |
| Smart Result 3 | 56 | ° | ° | ° | | | | ° |
| Smart Result 4 | 57 | ° | ° | ° | | | | ° |
| Smart Result 5 | 58 | | | | | | | ° |
| Smart Result 6 | 59 | | | | | | | ° |
| Smart Result 7 | 60 | | | | | | | ° |
| Analog Output 1 | 83 | ° | | | | ° | ° | ° |
| Analog Output 2 | 84 | ° | | | | ° | ° | ° |
| Timer 1 | 95 | ° | | | | ° | ° | ° |
| Timer 2 | 96 | ° | | | | ° | ° | ° |
| Smart Reset Offset 1 | 121 | | | | | | | ● |
| Smart Reset Offset 2 | 122 | | | | | | | ● |
| Clock - Seconds | 213 | | | | | ° | | |
| Clock - Minutes | 214 | | | | | ° | | |
| Clock - Hours | 215 | | | | | ° | | |
| Clock - Days | 216 | | | | | ° | | |
| Clock - Date | 217 | | | | | ° | | |
| Clock - Month | 218 | | | | | ° | | |
| Clock - Year | 219 | | | | | ° | | |
| Setpoint Latch | 221 | | | | | | | ● |
| Relay De-energize | 222 | | | | | | | ● |
| Zero Offset - Result | 227 | | | | | ° | | |
| Zero Offset - CH1 | 228 | | | | | ° | | |
| Zero Offset - CH2 | 229 | | | | | ° | | |
| Zero Offset - CH3 | 230 | | | | | ° | | |
| Zero Offset - CH4 | 231 | | | | | ° | | |

Resetting and Incrementing Using Setpoints

Setpoints may be used to reset and/or increment registers. In the example shown below, 2 liter soft drink bottles are being filled and packed 12 to a case. Using the setpoint reset and increment feature, the number of bottles and the total number of filled cases is easily calculated and displayed. Totalizer 1 counts from 0 to 2, resets, and repeats. CH 2 counts from 0 to 12, resets, and repeats.

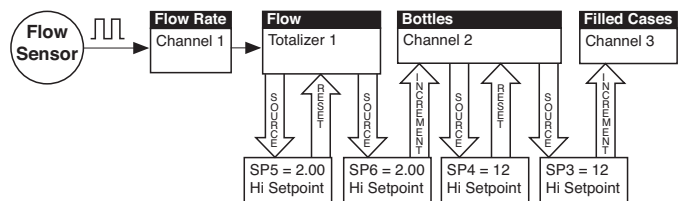

USING SETPOINTS TO INCREMENT AND RESET REGISTERS

Functional Diagram

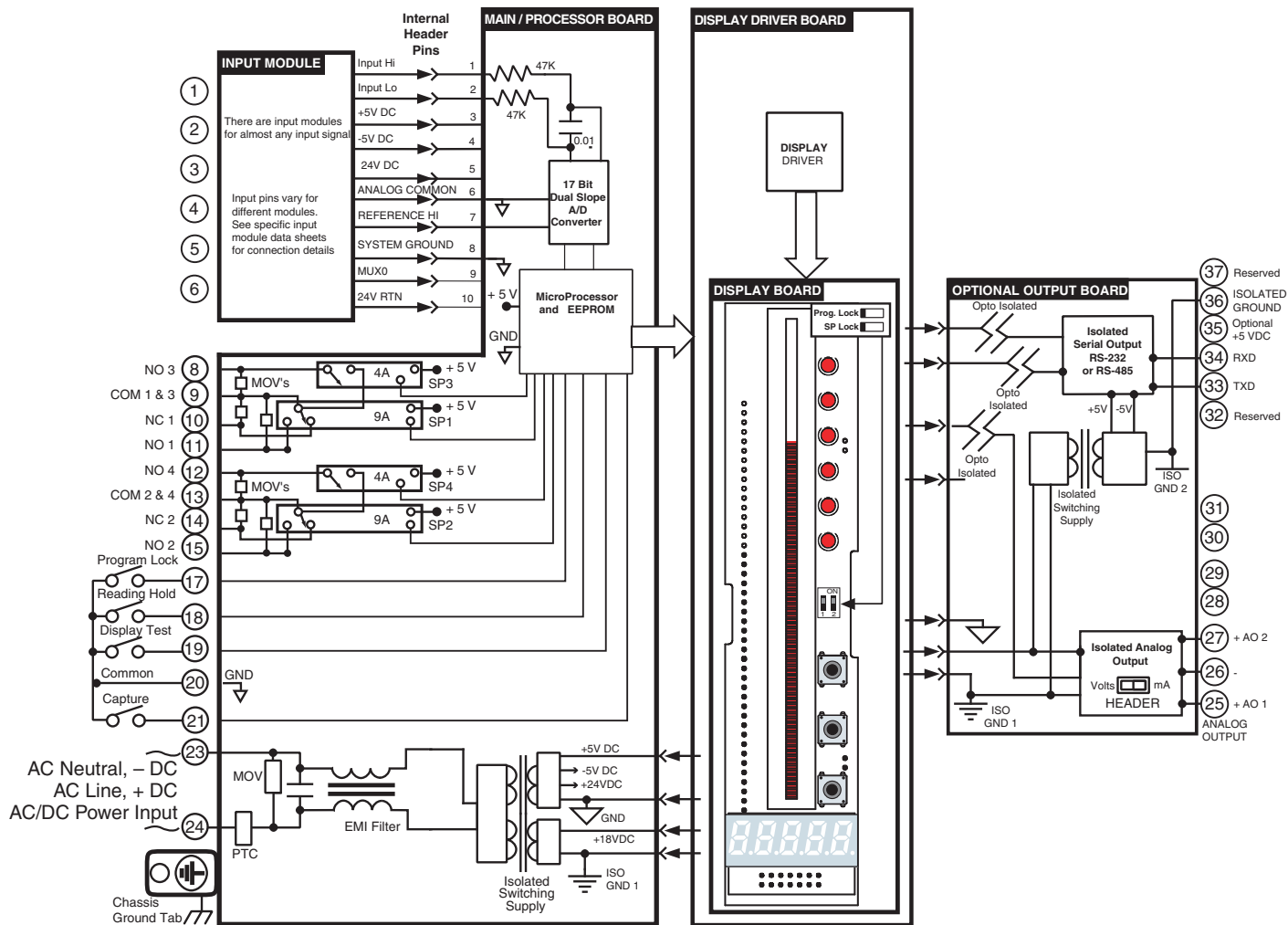

Connector Pinouts

Rear Panel Pinout Diagram

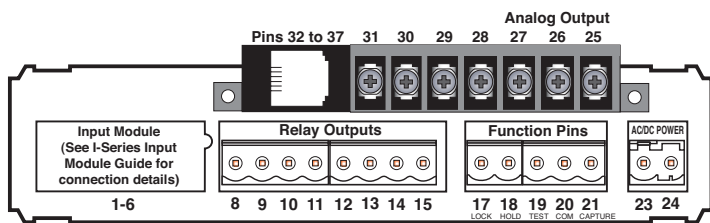

WARNING: AC and DC input signals and power supply voltages can be hazardous. Do Not connect live wires to screw terminal plugs, and do not insert, remove or handle screw terminal plugs with live wires connected.

Input Signal – Pins 1 to 6

See the *I-Series Input Signal Modules Guide (Z87)* for connection details of all input modules. On most single input signal conditioners, usually Pin 1 is the signal high pin (Hi +) and Pin 3 is the signal low pin (Lo -).

Function Pins – Pins 17 to 21

Pin 17 – Program Lock. By connecting the PROGRAM LOCK pin to the COMMON pin (pin 11 on the main PCB), the PROGRAM LOCK pin allows the meter's programmed parameters to be viewed but not changed.

Pin 18 – Hold Reading. By connecting the HOLD READING pin to the COMMON pin (pin 11), the HOLD READING pin allows the meter's display to be frozen. However, A/D conversions continue

NOTE: The meter uses plug-in type screw terminal connectors for most input and output connections and an RJ-6 phone connector for the optional RS-232 or RS-485 serial outputs.

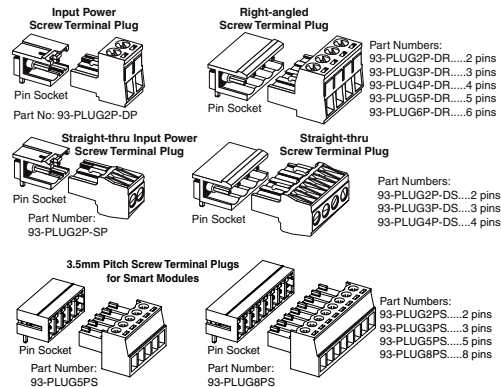

and as soon as pin 9 is disconnected from pin 11 the updated reading is instantly displayed.

Pin 19 – Display Test and Reset. The DISPLAY TEST and RESET pin provides a test of the meter's display and resets the microprocessor when the DISPLAY TEST and RESET pin is connected to the COMMON pin (pin 11).

Pin 20 – Common. To activate the HOLD, TEST and RESET, or LOCKOUT pins from the rear of the meter, the respective pins have to be connected to the COMMON pin.

Pin 21 – Capture. Connecting the CAPTURE pin (pin 21) to the COMMON pin (pin 11), allows a selected relay to be activated.

Chassis Ground Tab. Only on versions with metal sheath casing.

Carrier Board Output Pins

Analog Output

Pins 25 to 27 – Analog Output Pins. The analog output pins are:

Pin 25 – Positive (+) analog output 1.

Pin 26 – Negative (–) analog output 1 and 2.

Pin 27 – Positive (+) analog output 2.

SSR Output

Pins 28 to 31 – SSR Output Pins.

Pin 28 – Normally open 6 (SP6) 210 mA, 300 VDC SSR.

Pin 29 – Common 6 (SP6).

Pin 30 – Normally open 5 (SP5) 210 mA, 300 VDC SSR.

Pin 31 – Common 5 (SP5).

Serial Outputs RS-232 or RS-485

Pins 32 – 37 Serial Comm. Pinouts for RS-232 & RS-485.

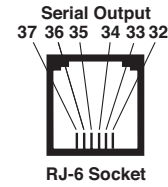

| Pin No. | RS-232 | RS-485 |
|---------|-------------------------------------|-------------------------------------|
| 32 | Reserved for future use | Reserved for future use |
| 33 | RXD. Received Serial | B (Low) |
| 34 | TXD. Transmitted Serial | A (High) |
| 35 | +5 VDC to power external converters | +5 VDC to power external converters |
| 36 | Isolated Ground | Isolated Ground |
| 37 | Reserved for future use | Reserved for future use |

Relay Options

The meter has relay options on the main / processor board.

The main / processor board supports up to four electro-mechanical relays. Combined they provide 16 options ranging from a single 4 A Form A relay up to a maximum of two 4 A Form A and two 9 A Form C.

Electromechanical Relays

The main / processor board supports relay combination options using up to four electromechanical relays. A maximum of two 4 A Form A and two 9 A Form C relays. Relay outputs for one to four setpoints can be ordered for factory installation on the main board in any required combination of up to two 9A form C and two 4A form A relays.

| Main / Processor Board | | | | | | | | |
|--------------------------------|---------|---------------------------------------|--------------------------------|-------------------------------|---------------------------------------|-------|----|--|
| 8 | 9 | 10 | 11 | 12 | 13 | 14 | 15 | PIN Numbers |
| NO3 SP3 4 A Form A Relay | COM 1&3 | NC1 NO1 SP1 9 A Form C Relay | NO4 SP4 4 A Form A Relay | COM 2&4 | NC2 NO2 SP2 9 A Form C Relay | | | Maximum 2 groups of 1 x 9 A Form C & 1 x 4 A Form A Relays using one Common Pin per group |
| Options | | | | | | | | |
| SP3 | | SP1 | | SP4 | | SP2 | | |
| 4A | | Blank | | Blank | | Blank | | |
| 4A | | Blank | | 4A | | Blank | | |
| Blank | | 9A | | Blank | | Blank | | |
| Blank | | 9A | | Blank | | 9A | | |
| 4A | | 9A | | Blank | | 9A | | |
| 4A | | 9A | | 4A | | 9A | | |
| 4A | | 9A | | 4A | | Blank | | |
| 4A | | 9A | | Blank | | Blank | | |
| PIN 9 COMMON for SP1, SP3 | | | | PIN 13 COMMON for SP2, SP4 | | | | |

Modular Construction

The Tiger 320 Series of 32-bit Programmable Meter Controllers incorporates, in one instrument, all the different functions required by today's automation and process control applications. This is made possible by modular construction, around standard case sizes, built to American, European, and Japanese standards.

The range comes with a wide variety of display options, including 5 or 6-digit numeric or alphanumeric displays, 6-digit LCD displays, and 51 or 101-segment red, green, or tri-color straight and circular bargraphs.

All meters are housed in one of three DIN case sizes, or the popular 4" ANSI case, and provide the ideal solution for your measurement and process control applications.

Modular construction ensures you don't have to pay for unnecessary hardware. Simply order the input and output options to suit your application.

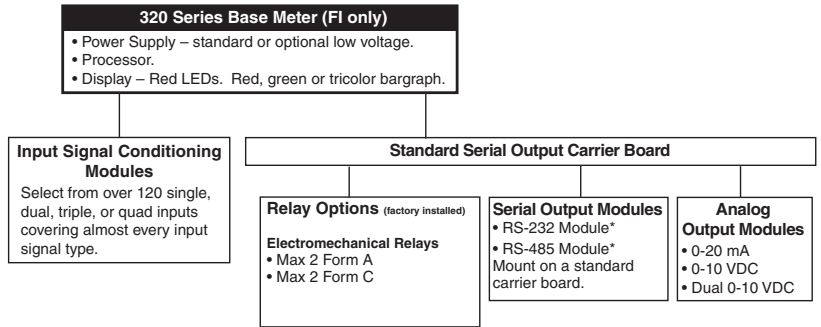

Tiger 320 Series Modular Construction

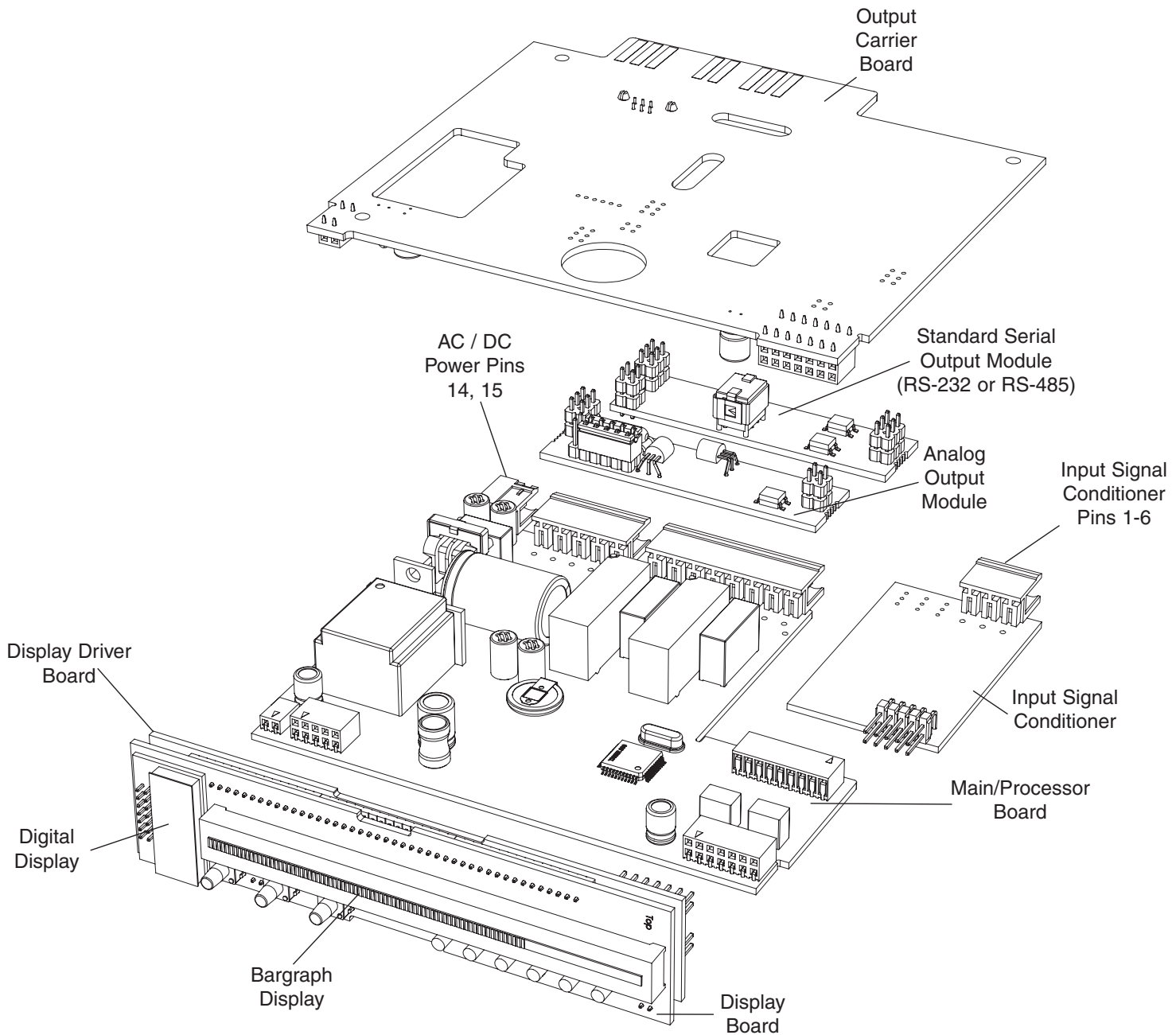

Exploded View of Meter Modular Boards

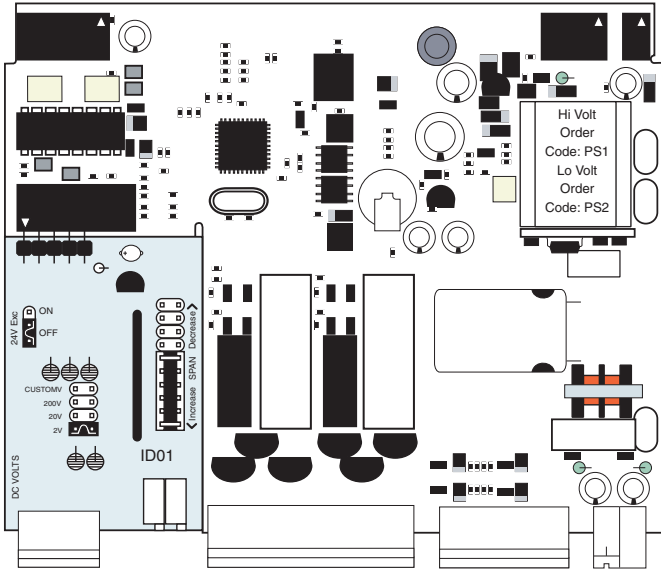

Input Signal Conditioner PCB

Main PCB*

*Shown with optional Input Signal Conditioning Module (Ordered Separately)

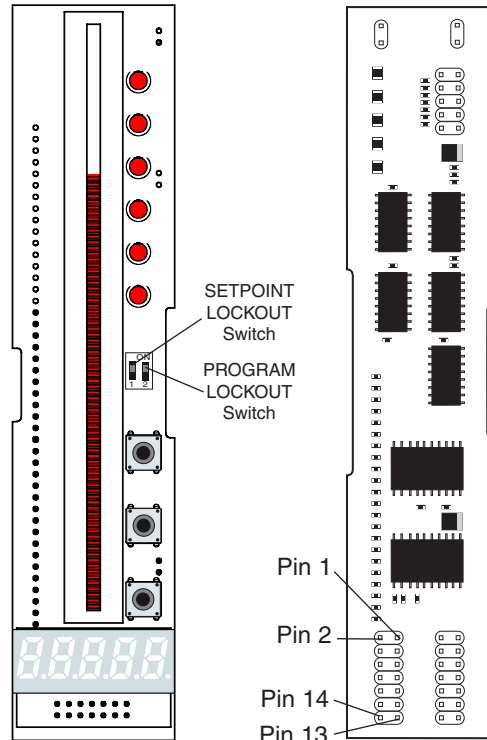

Display Board

Display Driver Board

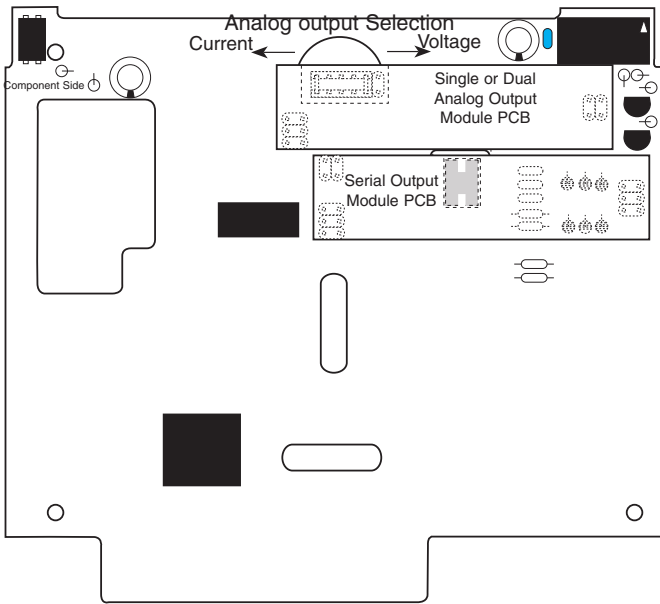

Standard Output Carrier Board*

*Shown with optional Analog Output Module and a Serial Output Module (RS-232, RS-485 or No Serial Output)

Analog Output Module PCB

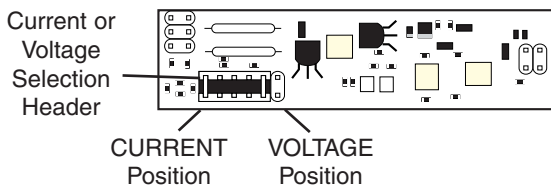

Available in Single (0-4-20mA or 0-10V) or Dual (0-10V & 0-10V)

Standard Serial Output Modules RS-232 or RS-485

Note:

Externally mounted Ethernet compatible communication output modules are available that connect directly to the standard (RS-232 / RS-485) serial module outputs.

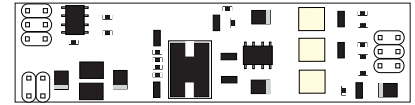

RS-485 Output Module PCB



RS-232 Output Module PCB

Opto Isolated I/O Modules Connect to External DIN Rail Mounting Breakout Box

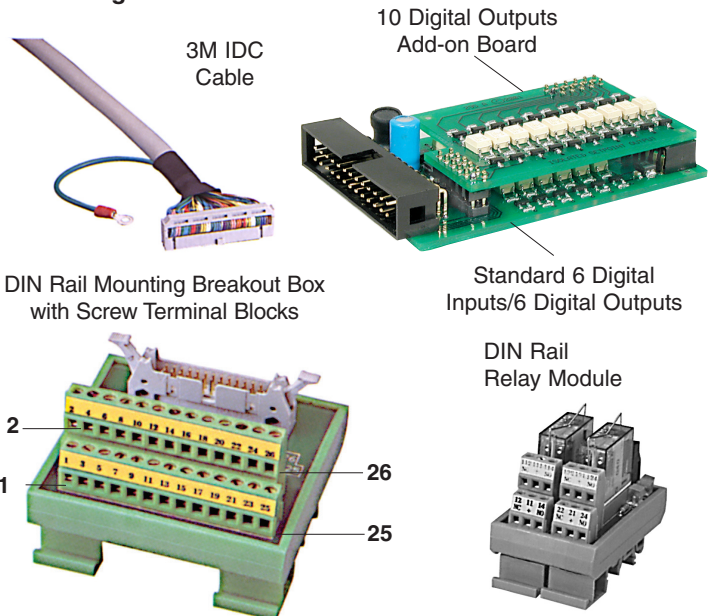

Installation

1. Install and wire meter per local applicable codes/regulations, the particular application, and good installation practices.
2. Install meter in a location that does not exceed the maximum operating temperature and that provides good air circulation.
3. Separate input/output leads from power lines to protect the meter from external noise. Input/output leads should be routed as far away as possible from contactors, control relays, transformers and other noisy components. Shielding cables for input/output leads is recommended with shield connection to earth ground near the meter preferred.
4. A circuit breaker or disconnect switch is required to disconnect power to the meter. The breaker/switch should be in close proximity to the meter and marked as the disconnecting device for the meter or meter circuit. The circuit breaker or wall switch must be rated for the applied voltage (e.g., 120VAC or 240VAC) and current appropriate for the electrical application (e.g., 15A or 20A).
5. See *Case Dimensions* section for panel cutout information.
6. See *Connector Pinouts* section for wiring.
7. Use 28-12 AWG wiring, minimum 90°C (HH) temperature rating. Strip wire approximately 0.3 in. (7-8 mm).
8. Recommended torque on all terminal plug screws is 4.5 lb-in (0.51 N-m).



| | | | |
|--|--------------|--|------------------|
| Analog Output / Analog Retransmission | 12-13 | Code 8 - Data Logging & Print Mode | 34 |
| Calibration of Analog Output..... | 12 | Code 9 - Functions for Digital Input Pins | 34 |
| Dual (0-10V) Analog Output..... | 12 | Code 10 - Bargraph Display Configuration | 17-18 |
| Location of Analog Output Module | 45 | Code Blanking | 10-11 |
| Pinout of Analog Output..... | 46 | Clock/Timer | |
| Scaling of Analog Output | 12-13 | Configuration..... | 28, 31, 32 |
| Select Source for Analog Output | 12 | Real-time Clock Configuration | 28, 31, 32 |
| Auto Zero Maintenance for Weighing Applications | 12 | Real-time Clock Date | 34 |
| Set Parameters for CH1, CH2, CH3 & CH4 | 11 | Time Stamp..... | 34 |
| Averaging - Digital Filtering | 13 | Component Layout & External Devices | |
| Set Parameters for CH1, CH2, CH3 & CH4 | 12 | Modular Construction | 45 |
| Block Diagram of Software & Hardware | 4 | Component Layout..... | 46 |
| Brightness Display | 11 | Connections | |
| Calibration | 12-15 | Carrier Board Output Pinouts..... | 44 |
| Calibration Thermocouple or RTD | 12 | Connector Pinouts..... | 43 |
| Manual Calibration | 14 | External Devices | 46 |
| Single-Point Calibration..... | 14 | Rear Panel Pinout Diagram | 43 |
| Two-Point Calibration | 14 | Controls & Indicators | 5-6 |
| Case Dimensions | 50 | Annunciator LEDs | 5 |
| Modular Construction..... | 45 | Down Button..... | 5 |
| Channel 1 Settings | 28-29 | Error Message..... | 6 |
| 32 Point Linearization..... | 29 | LED Display..... | 5 |
| Analog Input Signal Sample Rate..... | 28 | Program Button | 5 |
| Counter/Resident Timer/Clock | 28 | Program Lockout Switch | 6 |
| Measurement Task | 28 | Scrolling Display Text Messaging..... | 5 |
| Post Processing | 29 | Setpoint Lockout Switch..... | 6 |
| Print Mode..... | 29 | Seven Segment LED Displays | 5 |
| Sampling Rate..... | 28 | Up Button | 5 |
| Serial Mode..... | 29 | Data Logging | |
| Smart Input Module..... | 28 | Downloading Logged Data from Meter | 34 |
| Channel 2 Settings | 30 | Printing Logged Data | 34 |
| Channel 3 Settings | 31 | Real-time Clock..... | 34 |
| Channel 4 Settings | 32 | Digital Input Pins | 34 |
| Channel 1 & Channel 2 Results Processing | | Display Brightness Setting | 11 |
| 32 Point Linearization..... | 33 | Display Functions | 16-27 |
| Maths Functions..... | 33 | Bargraph Colors | 17 |
| Code 1 - Display Configuration | 16-27 | Bargraph Display..... | 18 |
| Configure Bargraph Colors Procedure..... | 25 | Data Source | 21 |
| Configure Bargraph Using Linear Scaling Procedure..... | 26 | Display Format and Decimals | 22 |
| Configure Bargraph Using Logarithmic Scaling..... | 27 | Display Rounding | 22 |
| Configure Data Source Procedure..... | 21 | Last Digit Text Character | 23 |
| Configure Display Format Mode Procedure..... | 22 | Setpoint Annunciator Mode..... | 24 |
| Configure Last Digit Text Char. Procedure..... | 23 | Update at Sample Rate..... | 24 |
| Configure Setpoint Annunciators Procedure..... | 24 | Filtering | |
| Configure Update at Sample Rate Procedure | 24 | <i>See Averaging Samples & Averaging Window</i> | |
| Data Source - 2nd Digit [X5X]..... | 16 | Front Panel Controls | 5-6 |
| Display Format - 2nd Digit [X6X]..... | 16 | Front Panel Programming Codes | 8-9 |
| Display Functions Mode..... | 16 | Main Programming Mode..... | 8 |
| Manual Loader Mode | 16 | On Demand Modes..... | 9 |
| Setpoint Annunciators Mode..... | 16 | Setpoint Programming Mode | 8 |
| Text Character - 2nd Digit [X7X] | 16 | View Modes..... | 9 |
| Update Display at Selected Sample Rate..... | 16 | Functional Diagram | 43 |
| Code 2 - Channel 1 Measurement Task | | General Features | 1 |
| and Sampling Rate | 28 | Hysteresis and Deviation | 35-89, 01 |
| Code 3 - Channel 1 Post Processing | | Initial Setup Procedures | 10-11 |
| and Serial Mode Functions | 29 | Code Blanking and Macro Check | 10-11 |
| Code 4 - Channel 2 Measurement Task | | Model and Software Code Version Check | 10 |
| and Sampling Rate | 30 | Input Signal Conditioning Modules | |
| Code 5 - Channel 3 Functions | 31 | Modular Position..... | 45 |
| Code 6 - Channel 4 Functions | 32 | | |
| Code 7 - Result Processing | 33 | | |

| | | | |
|---|--------------|----------------------|-------|
| Linearization | | Delay Settings | 41 |
| Channel 1 Temperature Sensors | 28 | Modes | 37-38 |
| Channel 1 User Loaded Tables | 29 | Totalizers | |
| Channel 2 Temperature Sensors and User Loaded Tables | 30 | Setting | 12-13 |
| Channel 3 Temperature Sensors and User Loaded Tables | 31 | | |
| Channel 4 Temperature Sensors and User Loaded Tables | 32 | | |
| Result of CH1 & CH2 User Loaded Tables | 33 | | |
| Table Settings | 13, 33 | | |
| Macros | | | |
| Macro Check | 10-11 | | |
| Manual Loader | 16 | | |
| Math Function | | | |
| Cross Channel Math | 4, 33 | | |
| Result Processing | 33 | | |
| Modbus | 13 | | |
| Model Type Check | 10 | | |
| On Demand Functions | 12 | | |
| | | | |
| Panel Cutout | 50 | | |
| PID Control Settings | 36 40 | | |
| Power Supply | 43 | | |
| Prescaling | | | |
| Channel 1 | 28 | | |
| Channel 2 | 30 | | |
| Print Mode | 29 | | |
| Programming Codes | 8-9 | | |
| Programming Conventions | 7 | | |
| Registers | | | |
| Registers That Can Be Selected | 42 | | |
| Registers That Should Not Be Selected | 42 | | |
| Resetting and Incrementing Using Setpoints | 42 | | |
| Relay Options | 44 | | |
| Serial Communication | | | |
| Configuration | 29 | | |
| Pinouts | 44 | | |
| Setpoint Programming Mode | 35-41 | | |
| Data Logging | 36 | | |
| Data Printing to PC | 36 | | |
| Data Printing to Serial Printer | 36 | | |
| Display Flashing | 36 | | |
| Hysteresis or Deviation | 36-38, 40 | | |
| Level 1 - Basic Mode - Prog. Procedures | 39 | | |
| PID Control Settings | 36, 40 | | |
| Real-time Clock Option | 36 | | |
| Real Time Control Modes | 37-38 | | |
| Relay Energize Functions | 36 | | |
| Setpoint & Relay Control Settings | 35, 40 | | |
| Setpoint Activation Source | 36 | | |
| Setpoint Activation Values | 35 | | |
| Setpoint Latching | 36 | | |
| Setpoint Reset & Trigger | 36, 41 | | |
| Setpoint Tracking | 36 | | |
| Timer Modes | 36, 41 | | |
| Smart Input Modules | | | |
| Setting Up | 28 | | |
| Table of Contents | 1 | | |
| Timers | 36 | | |
| Configuration | 28, 31, 32 | | |

Case Dimensions

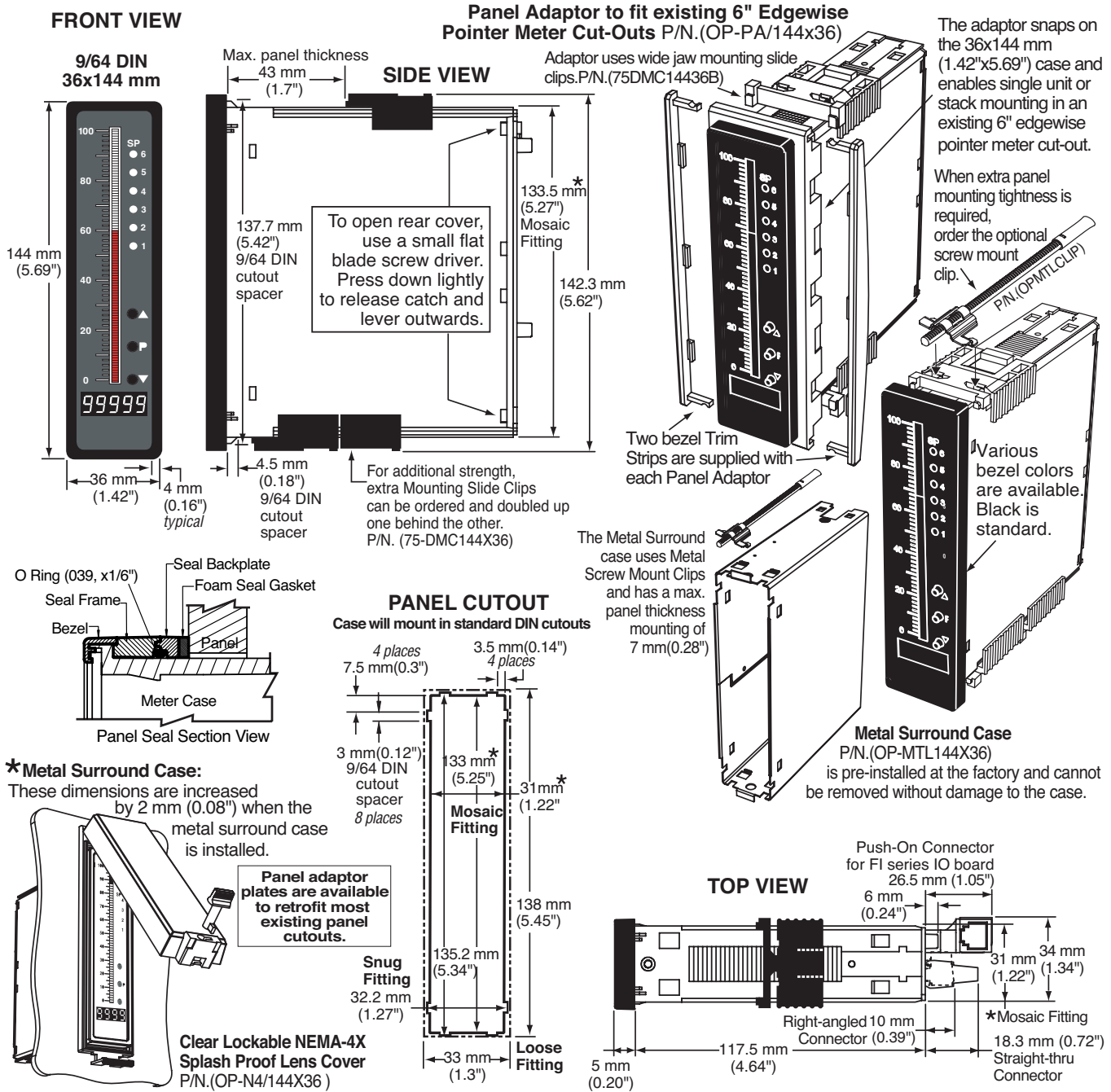

WARRANTY

Texmate warrants that its products are free from defects in material and workmanship under normal use and service for a period of one year from date of shipment. Texmate's obligations under this warranty are limited to replacement or repair, at its option, at its factory, of any of the products which shall, within the applicable period after shipment, be returned to Texmate's facility, transportation charges pre-paid, and which are, after examination, disclosed to the satisfaction of Texmate to be thus defective. The warranty shall not apply to any equipment which shall have been repaired or altered, except by Texmate, or which shall have been subjected to misuse, negligence, or accident. In no case shall Texmate's liability exceed the original purchase price. The aforementioned provisions do not extend the original warranty period of any product which has been either repaired or replaced by Texmate.

USER'S RESPONSIBILITY

We are pleased to offer suggestions on the use of our various products either by way of printed matter or through direct contact with our sales/application engineering staff. However, since we have no control over the use of our products once they are shipped, NO WARRANTY WHETHER OF MERCHANTABILITY, FITNESS FOR PURPOSE, OR OTHERWISE is made beyond the repair, replacement, or refund of purchase price at the sole discretion of Texmate. Users shall determine the suitability of the product for the intended application before using, and the users assume all risk and liability whatsoever in connection therewith, regardless of any of our suggestions or statements as to application or construction. In no event shall Texmate's liability, in law or otherwise, be in excess of the purchase price of the product.

Texmate cannot assume responsibility for any circuitry described. No circuit patent or software licenses are implied. Texmate reserves the right to change circuitry, operating software, specifications, and prices without notice at any time.



450 State Place • Escondido, CA 92029

Tel: 1-760-598-9899 • USA 1-800-839-6283 • That's 1-800-TEXMATE

Fax: 1-760-598-9828 • Email: sales@texmate.com • Web: www.texmate.com

Texmate has facilities in Japan, New Zealand, Taiwan, and Thailand.

For product details visit www.texmate.com

Local Distributor Address