



Optional Custom Facoplate
Optional Green LED Display

Optional Large
0.8" LED Display

Dust and Splash proof
Membrane Face Plate

DX-35-CL

4-20mA Process Loop

3 1/2 Digit with 0.56" or 0.8" LEDs

in a 1/8 DIN Case

Easily user scaled, this meter is ideal for 4-20mA process loop measurement and indication in any engineering unit of measure.

General Features

The DX-35-CL is cost-effective 4-20mA process loop measuring meter. It is easily user adjustable to any reading between -1999 and +1999 without component changes. The unique set of Signal Conditioning Components incorporated in this meter, enables the use of a simple two step scaling and calibration procedure, which eliminates the back and forth interaction between zero and span settings, which is often required to calibrate less finely engineered products.

Typical Application Connections

4 to 20mA Process Loop Measurement

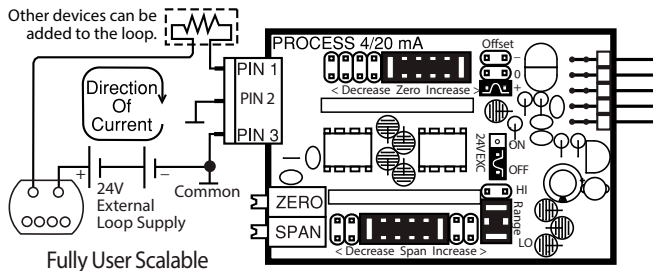

Order IP02, if you require the loop excitation voltage to be supplied by the meter.

Compatibility

The DX-Series have a matching DIN case style that is complementary to the Leopard and Tiger family of meters. DX-Meters are the OEM's choice for switchboard and process indication. Each model is dedicated to a specific application and designed for quick and easy installation.



Specifications

- Input Configuration:**... Series connection to 4-20mA process loop.
- Full Scale Ranges:**..... User adjustable to any scaling between -1999 to +1999
- Loop Excitation:**.....Optional. 24V DC at 125mA. Provided by the meter when IP02 is ordered.
- A/D Converter:**.....12 bit dual slope
- Input Impedance:**.....84.7Ω maximum, 1.4V drop
- Accuracy:**.....±(0.05% of reading + 3 counts)
- Temp. Coeff.:**.....100 ppm/°C (Typical)
- Warm up time:**.....1 minute to specified accuracy.
- Conversion Rate:**.....3 reading per second
- Display:**.....**3 1/2 digit 0.56" Red LED display (std),** 0.56" GREEN, 0.8" RED/GREEN or 0.56" Super Bright RED are optional.
- Decimal Selection:**.....Header under face plate, X•X•X•X
- Positive Overrange:**...The MSD digit 1 is displayed with all other digits blank.
- Power Supply:**.....AC/DC Auto sensing wide range supply
 - PS1 (std)85-265 VAC, 50-400Hz / 95-300 VDC @1.5W
 - PS215-48 VAC,50-400Hz / 10-72 VDC @4.0W
- Operating Temp.:**.....-10 to 50 °C
- Storage Temp.:**.....-20 °C to 70 °C.
- Relative Humidity:**.....95% (non condensing)
- Case Dimensions:**.....1/8 DIN, Bezel: 96x48 mm (3.78"x1.89")
 - Depth behind bezel: 117 mm (4.61")
 - Plus 11.8 mm (0.47") for Right-angled connector or plus 20 mm (0.79") for Straight-thru connector.
- Weight:**.....8 oz., 11 oz when packed.
- Certification:**.....UL Listed.

DX-Series, the OEMs choice for switchboard and process indication

- DX-35-DCV**..... DC volts ±2V/±20V/±200V Header Selectable Ranges, 3.5 digit
- DX-35-DCA**.....DC mV ±50mV, ±100mV, ±200mV Header Selectable Ranges, 3.5 digit
- DX-35-ACV**.....AC volts, Scaled RMS (True RMS Opt.). 199.9/300V AC Header Selectable Ranges, 3.5 digit
- DX-35-ACA**.....AC amps, Scales RMS (True RMS Opt.). (5 Amp Internal Shunt), 3.5digit
- DX-35-CL**..... Process 4 to 20mA (100.0), easily user scalable, 3.5 digit w/Exc. opt
- DX-35-HZ**..... AC Line Frequency 15.0Hz to 199.9Hz. Up to 300V AC input, 3.5 digit
- DX-35-TC-KF**..... K Thermocouple with °F, optional °C, 3.5 digit
- DX-35-TC-JF**..... J Thermocouple with °F, optional °C, 3.5 digit
- DX-35-RTD-F**.....100Ω platinum RTD, 3 or 4 wire, °F in 1° resolution, optional °C, 3.5 digit
- DX-40-ACV**..... AC volts, Scaled RMS (True RMS Opt.). 300.0V AC full scale, 4 digit
- DX-45-ACA**..... AC amps, Scaled RMS (True RMS Opt.). (5 Amp Internal shunt), 4.5 digit
- DX-45-DCV**..... DC volts ±2V/±20V/±200V Header Selectable Ranges, 4.5 digit
- DX-45-DCA**.....DC mV ±50mV/±100mV/±200mV Header Selectable Ranges, 4.5 digit
- DX-45-CL**..... Process 4 to 20mA (100.0), easily user scalable, 4.5 digit w/Exc opt.

Connector Pinouts

This meter uses plug-in type screw terminal connectors for all connections.

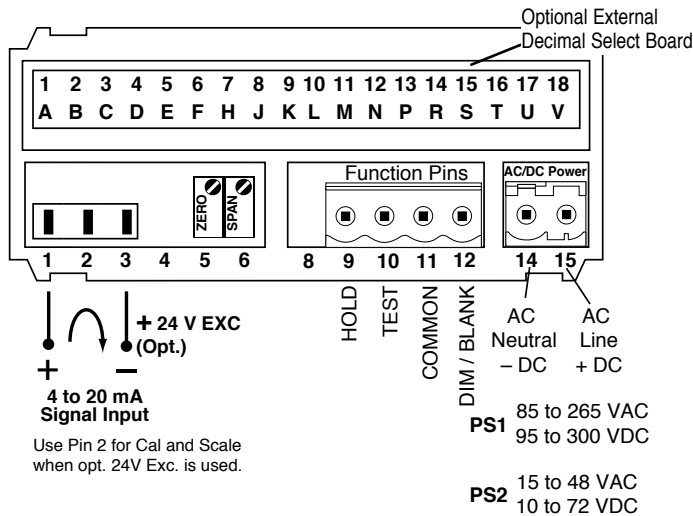

Pin Descriptions

Pin 1 - Signal Input High: Signal high input for the meter.

Pin 2- Signal Input Low: Signal low input for calibration and scaling when the optional 24V excitation (IP02) is used.

Pin 3- Signal Input Low: Signal low input for the meter (IP01) or optional 24V Excitation (IP02).

Pin 9 - Hold: If this pin is left unconnected the meter will operate in a free running mode. When this pin is connected to the Common Pin 11, the meter display will be latched. A/D conversions will continue, but the display will not be updated until Pin 9 is disconnected from Pin 11.

Pin 10 - Display Test: When this pin is connected to the Common Pin 11, all segments of the display light up and 1888 is displayed. This is used to detect any missing segments in the display.

Pin 11 - Common: To Hold, Test or Dim the display, the respective pins have to be connected to this Common Pin.

Pin 12 - Dim/Blank: When this pin is connected to the Common Pin 11 the display is blanked out. If it is connected through an external 1KΩ pot, the display may be dimmed.

Pin 14 & 15 - AC/DC Power Input: These pins are the power pins of the meter and they only accept a special polarized screw terminal plug that can not be inserted into any other input socket. The standard meter has a auto sensing AC/DC power supply that operates from 85-265 VAC/95-300 VDC (PS1 Std). An optional isolated low voltage power supply that operates from 15-48 VAC/10-72 VDC (PS2) is also available.

OPTIONAL EXTERNAL DECIMAL POINT SELECTION BOARD

Pins 6, F - Decimal Common: Connect to these pins to activate decimals.

Pins 7, H - Decimal XXXX.: Connect to pin 6 or pin F to activate decimal XXXX..

Pins 8, J - Decimal XXX.X: Connect to pin 6 or pin F to activate decimal XXX.X.

Pins 9, K - Decimal XX.XX: Connect to pin 6 or pin F to activate decimal XX.XX.

Pins 10, L - Decimal X.XXX: Connect to pin 6 or pin F to activate decimal X.XXX.

Calibration Procedure

The first step is to disengage the ZERO Pot and scale down the Signal Span input to produce the desired Digital Display Span output.

Signal Span is defined as the total change of signal input that would be required for a specific change of the Digital Display. The largest Signal Span that can be specified with a 4 to 20mA input is 16mA. A 4mA Signal Span proportionately scaled can meet full scale display accuracy.

Digital Display Span is defined as the exact total in counts, that the display would change within a specific Signal Span. The largest Digital Display Span that can be displayed is -1999 to +1999 (4000 counts). 16mA can not display +4000, so instead 4mA can be scaled to +1000.

The second step is to select a Zero Offset Range and offset the Digital Display Span with the ZERO Pot, until the desired reading is displayed.

Maximum offset is -3000 to +2000 counts. A Digital Display Span of 4000 counts requires an offset of -3000 to display -1999 to +1999.

For example: A 4 to 20mA input to read -40.0°C to +199.9°C
Signal Span = 16mA, Digital Display Span = 2400 counts.

1. Remove the meter from its case and set the Zero Offset Range Header to the Calibrate position. Select the 1400 – 3000 position on the Span Adjust Header and slide the meter back into the case.
2. Connect power to the meter and apply 4mA (25% of 16mA). Adjust the SPAN Pot until the display reads +600 (25% of 2400). The meter is now scaled for a Signal Span of 16mA and a Digital Display Span of 2400 counts. In the example 4mA should read -400 and 20mA read 1999, therefore the Digital Display Span should be offset by -1000.
3. Disconnect power and remove the meter from the case, select the Negative offset position on the ZERO OFFSET RANGE Header, and slide the meter back into the case.
4. Connect power to the meter, apply 4mA and adjust the ZERO Pot until the display reads -400. With the Digital Display Span now offset by -1000 counts, the meter will read -400 for a 4mA input, and read +1999 for a 20mA input. Select decimal point 1XX.X to display -40.0 to +199.9. Then apply the self adhesive °C symbol (from the Face Plate Descriptor sheet provided) to complete the calibration.

Signal Conditioning Components

SPAN Potentiometer (Pot)

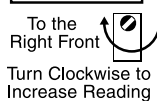

The 15 turn SPAN pot is always on the right side (as viewed from the back of the meter). Typical adjustment is 100% of the input signal range.

ZERO Potentiometer (Pot)

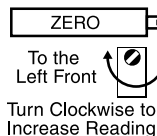

The ZERO pot when installed is always to the left of the SPAN pot (as viewed from the back of the meter). Typically it enables the input signal to be offset ±100% of full scale.

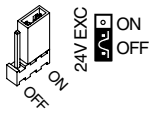

24V DC Output Header

On some modules this header enables a 24V DC 125mA (max) Excitation/Auxiliary output to be connected to Pin 3.

SPAN ADJUST Header

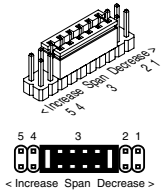

This unique five-position header expands the adjustment range of the SPAN pot into five equal 20% steps, across 100% of the input Signal Span. Any input Signal Span can then be precisely scaled down to provide any required Digital Display span from 1999 counts to 001 (one count).

	1	2	3	4	5
SPAN Adjust Header position	1	2	3	4	5
SPAN Pot %	20%	20%	20%	20%	20%
Signal Span %	20%	40%	60%	80%	100%

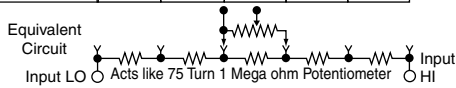

SPAN RANGE Header

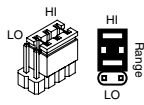

When this header is provided it works in conjunction with the SPAN ADJUST Header by splitting its adjustment range into a Hi and a Lo range. This has the effect of dividing the adjustment range of the SPAN pot into ten equal 10% steps across 100% of the input Signal Span.

	1	2	3	4	5	1	2	3	4	5
SPAN Adjust Header position	1	2	3	4	5	1	2	3	4	5
SPAN Pot %	10%	10%	10%	10%	10%	10%	10%	10%	10%	10%
Signal Span %	10%	20%	30%	40%	50%	60%	70%	80%	90%	100%

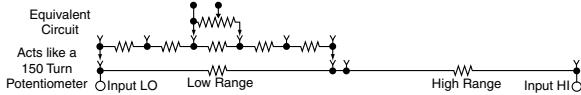

ZERO OFFSET RANGE Header

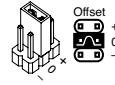

When provided, this three position header increases the ZERO pot's capability to offset the input signal, to $\pm 25\%$ of the digital display span. For example a Negative offset enables a 1 to 5V input to display 0 to full scale. The user can select negative offset, positive offset, or no offset (ZERO pot disabled for two step non-interactive span and offset calibration).

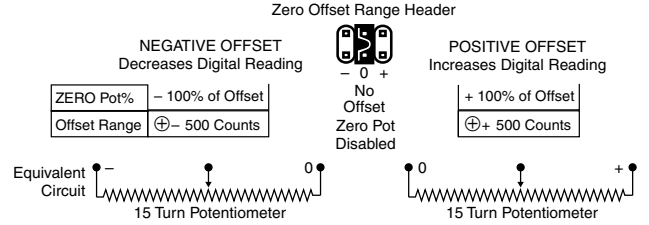

ZERO ADJUST Header

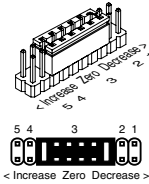

When this header is provided, it works in conjunction with the ZERO OFFSET RANGE Header, and expands the ZERO pot's offset capability into five equal negative steps or five equal positive steps. This enables virtually any degree of input signal offset required to display any desired engineering unit of measure.

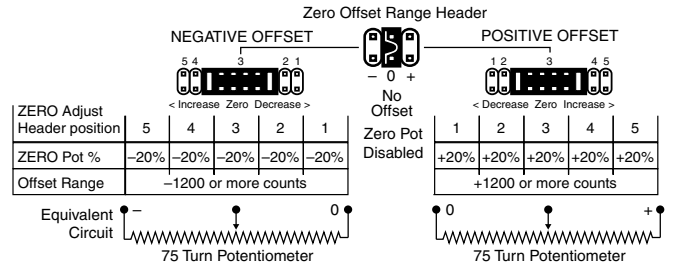

Component Layout

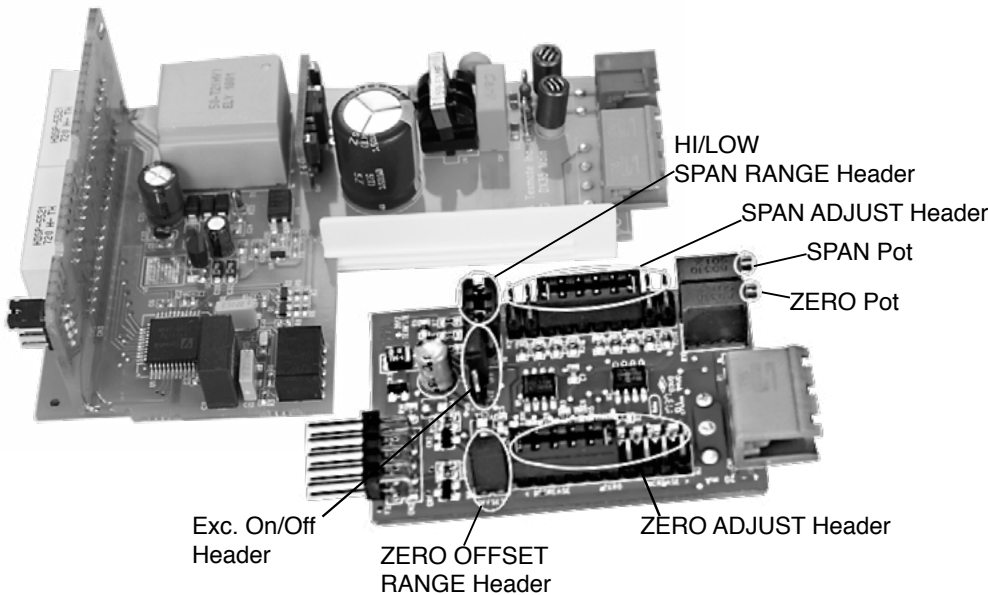

Opening Back Panel



To open back panel, insert a flat screwdriver or similar instrument in both slots on the top of the case and pry open. The DX-Series meters slide out from the rear of the case as a complete assembly.

Decimal Point Selection

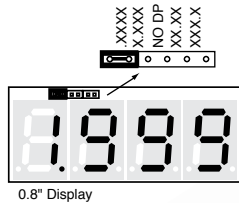
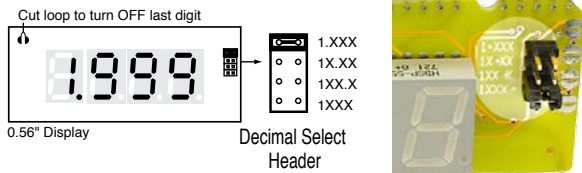

Decimal selection is made by moving the jumper to the indicated position on the header for the decimal required on the front of the display board.

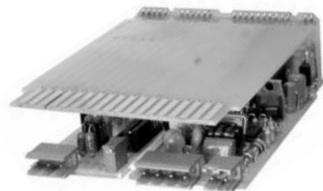

An optional output board is available that provides access to all decimal points via a rear PCB edge connector.

Optional External Decimal Point Selection Board

Connectors

This meter uses plug-in type screw terminal connectors for all input and output connections. The power supply connections (pins 14 and 15) have a unique plug and socket outline to prevent cross connection. The main board uses standard right-angled connectors.

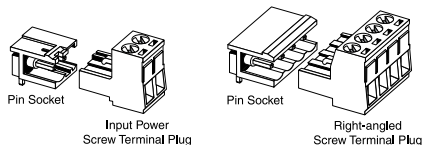

WARNING: AC and DC input signals and power supply voltages can be hazardous. Do Not connect live wires to screw terminal plugs, and do not insert, remove or handle screw terminal plugs with live wires connected.

Installation Guidelines

1. Install and wire meter per local applicable codes/regulations, the particular application, and good installation practices.
2. Install meter in a location that does not exceed the maximum operating temperature and that provides good air circulation.
3. Separate input/output leads from power lines to protect the meter from external noise. Input/output leads should be routed as far away as possible from contactors, control relays, transformers and other noisy components. Shielding cables for input/output leads is recommended with shield connection to earth ground near the meter preferred.
4. A circuit breaker or disconnect switch is required to disconnect power to the meter. The breaker/switch should be in close proximity to the meter and marked as the disconnecting device for the meter or meter circuit. The circuit breaker or wall switch must be rated for the applied voltage (e.g., 120VAC or 240VAC) and current appropriate for the electrical application (e.g., 15A or 20A).
5. See *Case Dimensions* section for panel cutout information.
6. See *Connector Pinouts* section for wiring.
7. Use 28-12 AWG wiring, minimum 90°C (HH) temperature rating. Strip wire approximately 0.3 in. (7-8 mm).
8. Recommended torque on all terminal plug screws is 4.5 lb-in (0.51 N-m).



Metal Surround Case Option

The meter's plastic case is made from fire retardant polycarbonate. A metal surround case can be ordered to enhance the meter's fire retardant capabilities and also provide shielding against electromagnetic interference (EMI). The metal case slides over the polycarbonate case and is held firmly in place by spring-type non-return clips. The Metal Surround Case must be factory installed on the polycarbonate case and once installed, it cannot be removed in the field.

With the metal case in place, the meter's standard ratchet-type mounting clips can not be used. Instead a pair of screw-type DIN standard mounting clips are provided, which clip into holes on the side of the metal case and tighten against the rear of the panel. A ground tab on the metal case enables the metal case to be easily connected to the panel ground.

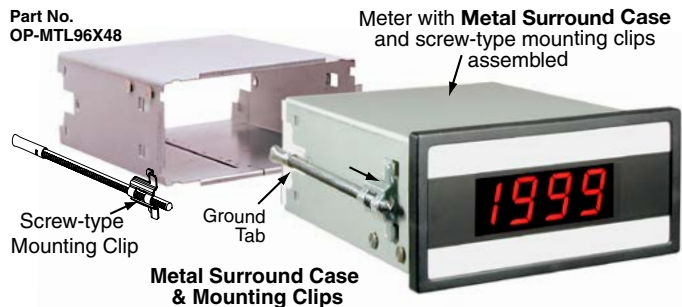

Clear Lockable Water-proof Cover

The clear lockable cover is designed to be dust and water proof to NEMA-4X, IP65 standards. The assembly consists of a base and cover with a cam hinge and key-lock fastening mechanism. An O-ring, or neoprene gasket forms a seal between the base and the panel. The cam hinge prevents the cover from closing when opened until pushed closed. The cover has a tapered recess that, when closed, forms a seal with a tapered spigot on the base. A key-lock employs a cam locking device to force the spigot into the recess, ensuring seal integrity. A safety catch keeps the cover closed even when the key is removed, and the keyhole can be used to attach a safety seal clip, preventing unauthorized opening.

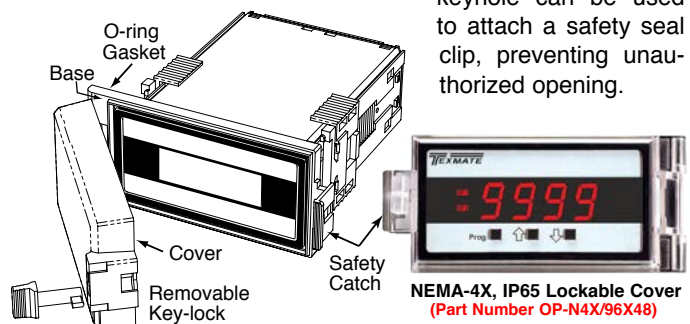

Optional Face Plate Descriptors

To customize the face plate, clear adhesive label containing various popular descriptors may be ordered. Choose the descriptor desired, peel off the adhesive backing and align the descriptor in the center right of the faceplate.



P.N.: DU-CASEDES

DX Case Dimensions and Panel Cutouts

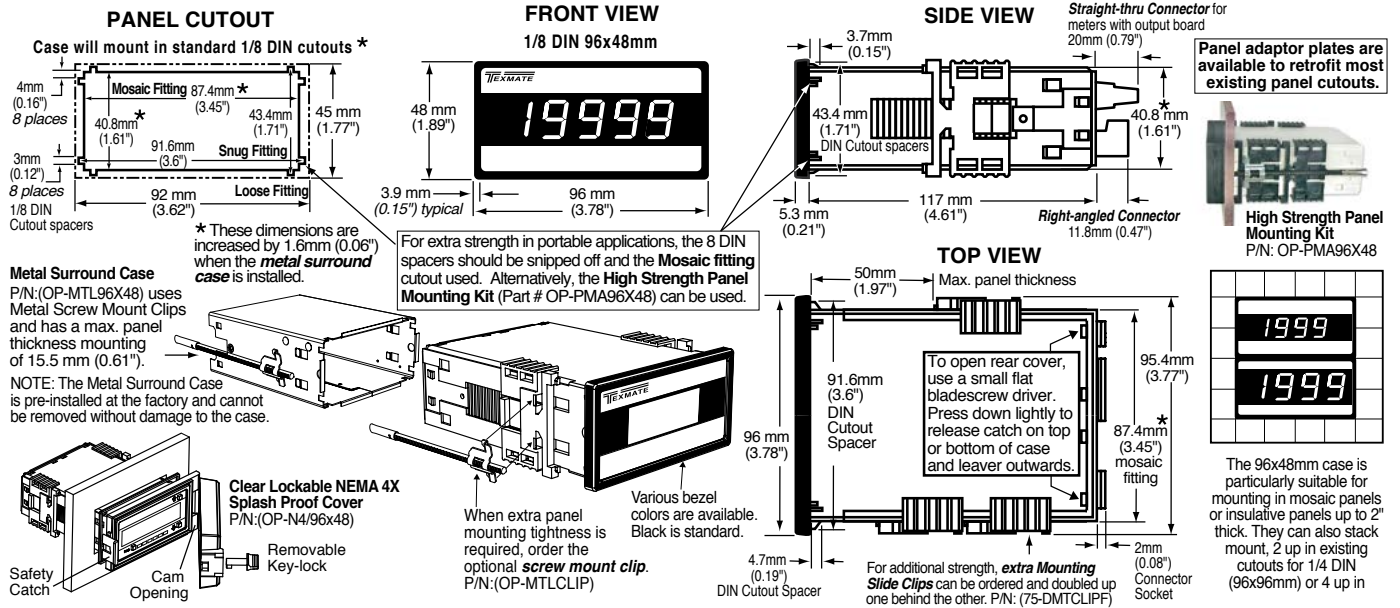

Ordering Information

Standard Options for this Model Number

Part Number	Description	List
-------------	-------------	------

► **BASIC MODEL NUMBER** Includes plug in type screw terminals, standard display and standard power supply unless optional versions are ordered.

DX-35-CL Process 4 to 20mA (100.0), IP01

Exc. option with 24V Excitation, IP02

► DISPLAY

DR ... Red LED, 0.56 inch high

DB ... Super-bright Red LED, 0.56 inch high

DG ... Green LED, 0.56 inch high

LG ... Large Green LED, 0.8 inch high

LR ... Large Red LED, 0.8 inch high

► POWER SUPPLY

PS1 .. 85-265VAC/95-300VDC

PS2 .. 15-48VAC/10-72VDC

Special Options and Accessories

Part Number	Description	List
-------------	-------------	------

► **SPECIAL OPTIONS (Specify Inputs or Outputs & Req. Reading)**

CR-CHANGE ... Calibrated Range Change to another Standard Range . . .

CS-3/3.5/4 . . . Custom display scaling within std. ranges

OP-DXEXTDP . . External Dec. Pt. W/Conn. Option-Factory Installed . . .

► **ACCESSORIES (Specify Serial # for Custom Artwork Installation)**

75-DBBZ9648F . . Extra Black Bezel for 96x48mm Case

75-DMTCLIPF . . Side Slide Brackets (2 pc) - extra set, extra strength

76-D35G-N4 . . . NEMA 4 Green LED Faceplate, Factory Installed

76-D35LG-N4 . . . NEMA 4 Large Green LED Faceplate, Factory Installed

76-D35LR-N4 . . . NEMA 4 Large Red LED Faceplate, Factory Installed

76-D35R-N4 . . . NEMA 4 Red LED Faceplate, Factory Installed

CN-L18 Dual Row 18 Pin Edge Connector, Solder Type

DN.CAS96X48B . Complete 96 X 48 mm Case with bezel

OP-MTLCLIP . . . Screw Mount Clips (2 pc) - to screw tighten slide brackets

OP-MTL96X48 . . Metal Surround Case, includes screw mounting clips

OP-N4X/96X48 . . 96x48mm clear lockable front cover-NEMA 4X, splash proof

OP-PSA/96X48 . . Panel to Case Seal Adapter with O-Ring and Foam Gasket

DU-CASEDES . . Clear adhesive descriptors label for face plate

WARRANTY

Texmate warrants that its products are free from defects in material and workmanship under normal use and service for a period of one year from date of shipment. Texmate's obligations under this warranty are limited to replacement or repair, at its option, at its factory, of any of the products which shall, within the applicable period after shipment, be returned to Texmate's facility, transportation charges pre-paid, and which are, after examination, disclosed to the satisfaction of Texmate to be thus defective. The warranty shall not apply to any equipment which shall have been repaired or altered, except by Texmate, or which shall have been subjected to misuse, negligence, or accident. In no case shall Texmate's liability exceed the original purchase price. The aforementioned provisions do not extend the original warranty period of any product which has been either repaired or replaced by Texmate.

USER'S RESPONSIBILITY

We are pleased to offer suggestions on the use of our various products either by way of printed matter or through direct contact with our sales/application engineering staff. However, since we have no control over the use of our products once they are shipped, **NO WARRANTY WHETHER OF MERCHANTABILITY, FITNESS FOR PURPOSE, OR OTHERWISE** is made beyond the repair, replacement, or refund of purchase price at the sole discretion of Texmate. Users shall determine the suitability of the proDxct for the intended application before using, and the users assume all risk and liability whatsoever in connection therewith, regardless of any of our suggestions or statements as to application or construction. In no event shall Texmate's liability, in law or otherwise, be in excess of the purchase price of the product.

Texmate cannot assume responsibility for any circuitry described. No circuit patent or software licenses are implied. Texmate reserves the right to change circuitry, operating software, specifications, and prices without notice at any time.



450 State Place • Escondido, CA 92029
Tel: 1-760-598-9899 • USA 1-800-839-6283 • 1-800-TEXMATE
Fax: 1-760-598-9828 • Email: orders@texmate.com • Web: www.texmate.com

DX-35-CL Technical Manual Copyright © 2018 Texmate Inc. All rights reserved. Published by: Texmate Inc. USA. Information in this Technical Manual is subject to change without notice due to correction or enhancement. The information described in this manual is proprietary to Texmate, Inc. and may not be copied, reproduced or transmitted, in whole or in part, in connection with the design, manufacture, or sale of apparatus, device or private label product without the express written consent of Texmate, Inc.