



LEOPARD FAMILY



0.56" or optional 0.8" large display red or green LED

DL-40JANUS

With or without an External Signal Source for Rescaling

A powerful, smart, programmable panel meter with optional Modbus RS-485 serial, analog and relays output for measurement and control applications in a 1/8 DIN 96x48mm case.

General Features

- External transmitters or signal conditioners can be eliminated by directly connecting of the sensor output to one of Texmate's 29 Plug-in Input Signal Conditioners that include:
 - AC Current
 - AC/DC Voltage
 - Load Cell
 - Pressure
 - Process
 - Prototype
 - Resistance
 - *Temperature
 - 4 to 20 mA
- *See models DL-40-RTD and DL-40-RTD for higher accuracy digitally linearized thermocouple and RTD
- Optional isolated 14 bit analog output. User or factory scalable to 4 to 20 mA, 0 to 20 mA or 0 to 10 V across any desired digital span from ± one count to the full scale range of – 1999 to 9999 (12000 counts).
- Optional Isolated Modbus RTU RS-485 serial communication with selectable baud rate (9600, 19200), address and parity.
- Auto-sensing AC/DC power supply. For voltages between **85-265 VAC / 95-300 VDC (PS1)** or 15-48 VAC / 10-72 VDC (PS2).
- 24 V DC excitation is available to power external transmitters and 5 or 10 V DC excitation is available for resistance bridge type sensors such as Load Cells and Pressure Transducers.
- Standard red or optional green or super bright red 4-digit LED display with range from –1999 to 9999 (12000 counts).
- Red or green 0.8" LED large display option
- Four annunciator LEDs provide front panel alarm status indication for up to four setpoints.
- Optional two 9 Amp Form C and two 4 Amp Form A relays or four 4 Amp Form A relays are available.
- Automatic intelligent averaging smooths noisy signals, while providing a fast display response to real input signal changes.
- Three-button programming via the front panel (UP, DOWN and PROGRAM buttons).

Software Features

- Front panel selectable four-level brightness control for digital display and setpoint LEDs.
- Four programmable setpoints.
- Relay activation can be selected to occur above (HI) or below (LO) each setpoint.
- Hysteresis setting for all four setpoints. Delay on make and delay on break for SP1 and SP2.
- Peak and Valley. View and Reset.
- Program Lock switch

Input Module Compatibility

LEOPARD FAMILY: More than 29 different Plug-in I-Series Input Signal Conditioners are approved for Texmate's Leopard Family of meters. Some examples are shown on pages 12 - 14. See www.texmate.com for an up to date listing.



LEOPARD

Specifications

Input Specs:Depends on Input signal conditioner
 A/D Converter:.....14 bit single slope
 Accuracy:.....±(0.05% of reading + 2 counts)
 Temp. Coeff.:100 ppm/°C (Typical)
 Warm up time:2 minutes
 Conversion Rate:.....5 conversions per second (Typical)
 Display:.....**4 digit 0.56" Red LED display (std),**
 0.56" or 0.8" Red, Green or Super Bright Red (optional)
 Range –1999 to 9999 counts.
 Polarity:.....Assumed positive. Displays – negative
 Decimal Selection:.....Front panel button selectable, X•X•X•X•
 Positive Overrange:.....Top segments of digital display flash
 Negative Overrange:.....Bottom segments of digital display flash
 Relay Output:Two 4 Amp Form A relays and two 9 Amp Form C, or 4 Amp form A relays.
 Analog Output:Isolated 14 bit user scalable mA or V
 AIC (mA out).....4-20 mA @ 0 to 500Ω max loop resistance.
 AIV (volts out).....0-10 V DC @ 500 Ω or higher resistance
 Power Supply:AC/DC Auto sensing wide range supply
PS1 (std).....85-265 VAC / 95-300 VDC, 50-400Hz @ 3W
 PS215-48 VAC / 10-72 VDC, 50-400Hz @ 2.5W
 Operating Temp.:.....0 to 60 °C
 Storage Temp:–20 °C to 70 °C.
 Relative Humidity:95% (non condensing)
 Case Dimensions:1/8 DIN, Bezel: 96x48 mm (3.78"x1.89")
 Depth behind bezel: 117 mm (4.61")
 Plus 11.8 mm (0.47") for Right-angled connectors, or plus 20 mm (0.79") for Straight-thru connector.
 Weight:6.5 oz., 8.5 oz when packed

Index

Auto Calibration Mode 5	Decimal Point & Brightness Selection . . 6	Lens Cover & Metal Surround Case 17	Ordering Information 18
Auto Calibration Procedure 5	General Features 1	Manual Rescaling 4	Setpoint & Relay Configuration Mode . . . 9
Case Dimensions 16	Glossary of Programming Symbols . . 2	Manual Rescaling Procedure 4	Software Features 1
Connector Pinouts 10-11	Input Module Analog Calibration . . . 15	Meter Assembly 10	Software Logic Tree 3
Controls and Indicators 2	Input Module Component Glossary 14-15	Modbus RTU & RS-485 Settings 7	Specifications 1
Digital Span Selection for Analog Range Output 6	Input Module Calibration 15-16	Modbus RTU Implementation 7	Two Point Analog Output Range Setting and Calibration 6
	Input Signal Conditioning Modules . 12-14	Modbus Address for DL-40 Registers 8	



Front Panel Buttons

Program Button

The **[P]** button is used to move from one program step to the next. When pressed at the same time as the **[↑]** button, it initiates the **calibration mode**. When pressed at the same time as the **[↓]** button, it initiates the **setpoint setting mode**.

Up Button

When in the operational display, pressing the **[↑]** button alone, allows you to view and reset the Peak and Valley (Highest and Lowest Readings.)

When in the **calibration mode** or the **setpoint setting mode** the **[↑]** button is used to increase the value of the displayed parameter.

Down Button

When in the operational display, pressing the **[↓]** button alone, allows you to view, but not change, the setting of setpoint 1,2,3 & 4.

When in the **calibration mode** or the **setpoint setting mode** the **[↓]** button is used to decrease the value of the displayed parameter.

Glossary of Programming Symbols

To explain software programming procedures, logic diagrams are used to visually assist in following the programming steps. The following symbols are used to represent various functions and associated display elements of the meter:

Symbol	Explanation
	This symbol represents the OPERATIONAL DISPLAY.
	This is the PROGRAM button.
	This is the UP button.
	This is the DOWN button.
	When a button is shown, press and release it to go onto the next step in the direction indicated by the arrow. When two or more buttons are shown, each with an arrow, this indicates that there is a number of programming choices.
	When two buttons are shown side by side and enclosed by a dotted line, they must be pressed at the same time then released to go onto the next programming step.
	If the display is shown with XXXX it means the value displayed will be the previously set value. When a number is shown it indicates the initial factory default setting or a specific "example number".

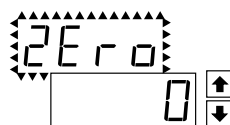

When two displays are shown together with bursts, this indicates that the display is toggling (flashing) between the name of the function and the value.

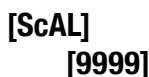

Text or numbers shown between square brackets in a procedure indicate the programming code name of the function or the value displayed on the meter display.

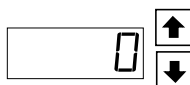

When the **[↑]** and **[↓]** buttons are shown together, the display value can be increased by pressing and releasing the **[↑]** button or decreased by pressing and releasing the **[↓]** button.

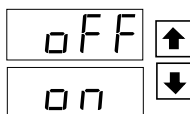

When the **[↑]** and **[↓]** buttons are shown with two displays, either display can be selected by pressing and releasing the **[↑]** or **[↓]** buttons.

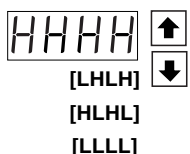

When there are more than two display selections they are shown in brackets below the first display and are also selectable by pressing and releasing the **[↑]** or **[↓]** buttons.

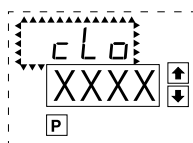

A dotted box indicates these functions are omitted or bypassed when the related hardware is not present

Software Logic Tree

The DL-40JANUS is an intelligent meter with a hierarchical software structure designed for easy programming and operation, as shown below in the software logic tree.

After the meter has been powered up, the four digits light up for three seconds and then settle to the operational display indicating the input signal.

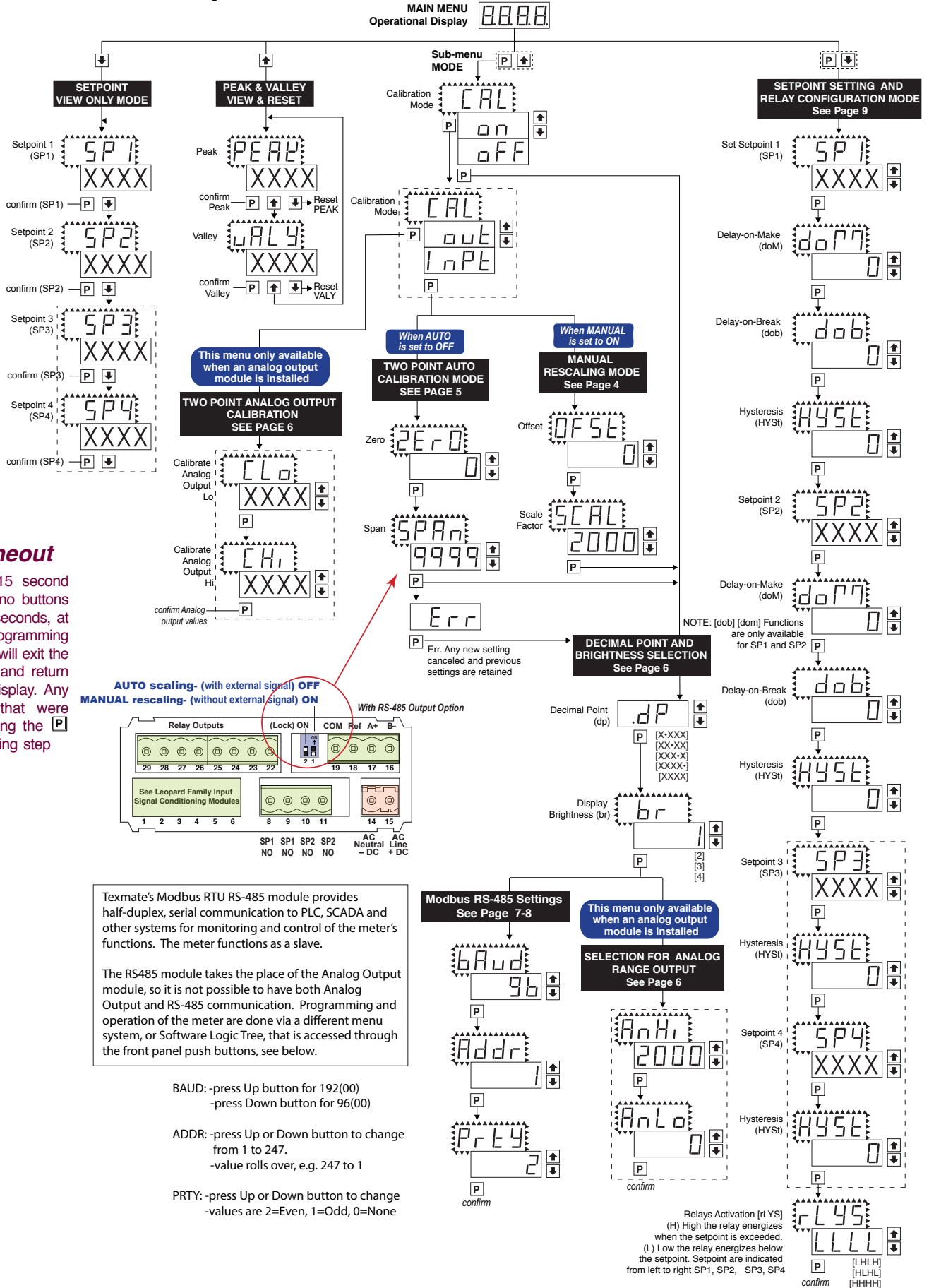

Manual Rescaling Mode

When the rear Auto/Manual switch is in the Manual position, the meter can be rescaled without applying an external signal by changing the oFSt (offset) and SCAL (scale) parameters in the user menu. A pre-calibrated Input Signal Conditioning module must be used. The meter assumes that this calibration used a true zero input (0V from conditioner to meter) resulting in a display value of 0 and a maximum input signal span (2V from conditioner to meter) resulting in a display value of the SCAL value set in the user menu. The linear equation is $y = mx + b$ where $m = (SCAL-0)/(2-0)$ and $b = oFSt$.

The default value of SCAL is 2000, but it may be set to any value between -1999 and +9999.

The internal Signal Span is limited to 3 V DC between- 1 V DC to+ 2 V DC. Any outputs from an Input Signal Conditioning module that exceed these limits will cause the meter to indicate overrange regardless of the Digital Display Span scaled. For example, an ID01 DC Volts Input Signal Conditioner can read +/-2VDC, but in the DL-40 will show under-range for a -1.2V input.

Manual Rescaling Procedure

STEP A Enter the Calibration Mode

- 1) Press the [P] and [M] buttons at the same time. Display toggles between [CAL] and [oFF].
- 2) Press and hold the [M] or [D] button. Display changes from [oFF] to [on].
- 3) Press the [P] button. Display toggles between [CAL] and [out].

STEP B Select Between Calibration of Input or Output

Note: If the analog output option is not present, Step B is skipped and the program goes directly from Step A to Step C.

- 1) Press the [M] or [D] button to select the display toggling from [CAL] to [inPt].
- 2) Press the [P] button. Display toggles between [oFSt] and the previous offset setting.

STEP C Set the Offset on the Digital Display

- 1) Using the [M] and [D] buttons, adjust the digital display to the desired offset. This is the reading that the meter will display for a zero input.
- 2) Press the [P] button. Display toggles between [SCAL] and the previous Scale factor.

STEP D Set the Scale factor on the Digital Display

- 1) Using the [M] and [D] buttons, adjust the meter display to the desired Scale factor. The default value is 2000, for which a 2V input will read 2000. If the scale factor is changed the display will change proportionately. Therefore if the Scale factor is changed to 1000 then for the same 2V input the display would read 1000.
- 2) Press the [P] button.

The Digital Calibration Procedure Mode is Now Complete.

The menu branches to the DECIMAL POINT AND BRIGHTNESS SELECTION, (see page6) and the display flashes [dP] and the previous decimal point selection.

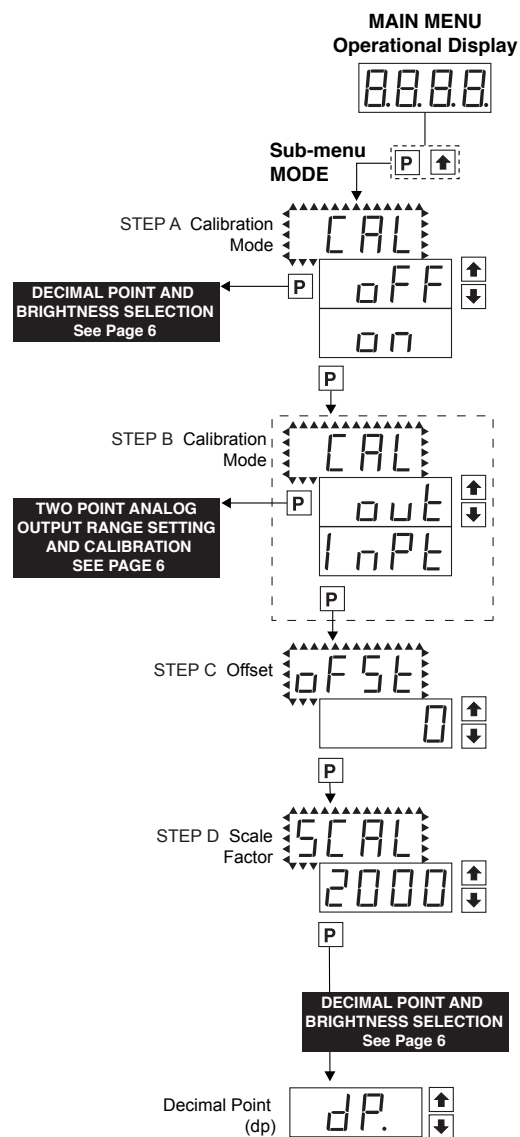

Auto Calibration Mode

When the rear Auto/Manual switch is in the Auto position, the meter can be calibrated with an automatic scale factor calculation, by applying a low input signal (InLo), entering the desired low display reading for that signal (ZERO), then applying a high input signal (InHi), and then entering the desired high display reading (SPAN). The meter then automatically calculates and programs in the requisite scale factor using a true linear ($y=mx + b$) calculation where $m = (SPAN-ZERO)/(InHi-InLo)$ and $b = ZERO$, but within the following parameters.

1. Positive and negative signals may be applied, but the difference between the high and the low signal inputs must be at least 1000 counts or Err will be indicated.
2. Positive and Negative values for the desired reading can be entered, but the scale factor created can not exceed the Digital Display Span capability of the meter which is 12,000 counts between -1999 to 9999.
3. The internal Signal Span is limited to 3 V DC between -1 V DC to +2 V DC. Any outputs from an Input Signal Conditioning module that exceed these limits will cause the meter to indicate overrange regardless of the Digital Display Span scaled.

Note: Most input signal conditioners have provisions for analog calibration and scaling. If the meter's digital scale factor is set to read zero with a zero input (shorted input), and to read 1000 with a 1.000 V input, any pre-calibrated signal conditioner with an output that does not exceed -1 V to +2 V, will read correctly in the meter without any further calibration.

Auto Calibration Procedure

STEP A Enter the Calibration Mode

- 1) Press the \square and \square buttons at the same time.
Display toggles between [CAL] and [oFF].
- 2) Press and hold the \square or \square button.
Display changes from [oFF] to [on].
- 3) Press the \square button. Display toggles between [ZEro] and the previous zero setting.

STEP B Select Between Two Point Digital Calibration of Input Signal and Two Point Analog Output

Note: If the analog output option is not present, Step B is skipped and the program goes directly from Step A to Step C.

- 1) Press the \square or \square button to select the display toggling from [CAL] to [inPt] input calibration.
- 2) Press the \square button. Display toggles between [ZEro] and the previous zero setting.

STEP C Set the Meter's Low Input Signal Reading on the Digital Display

- 1) Apply a zero or low signal to the meter.
(Positive or negative values are allowed)
- 2) Using the \square and \square buttons, adjust the meter display to the desired reading for the applied low input signal.
- 3) Press the \square button. Display toggles between [SPAN] and the previous span setting.

STEP D Set the Meter's High Input Signal Reading on the Digital Display

- 1) Apply a high input signal to the meter.
- 2) Using the \square and \square buttons, adjust the digital display to the desired reading for the applied high input signal.
- 3) Press the \square button.

The Digital Calibration Procedure Mode is Now Complete.

If the digital calibration was successfully completed, the menu branches to the DISPLAY FUNCTION CONFIGURATION MODE, (see page 7) and the display flashes [dP] and the previous setting.

ERROR Indicates Unsuccessful Calibration

If the calibration was unsuccessful, the display indicates [Err], the new calibration settings just entered will not take effect and the previously stored setting will remain.

The three most likely causes of an error during calibration are:

- 1) The full scale and zero signals were too similar. The full scale signal must be at least 1000 counts greater than the zero or low input signal (positive and negative values are allowed).
- 2) The scaling requirement exceeded the capability of the meter (-1999 to 9999).
- 3) No input signal present, or incorrect connections.

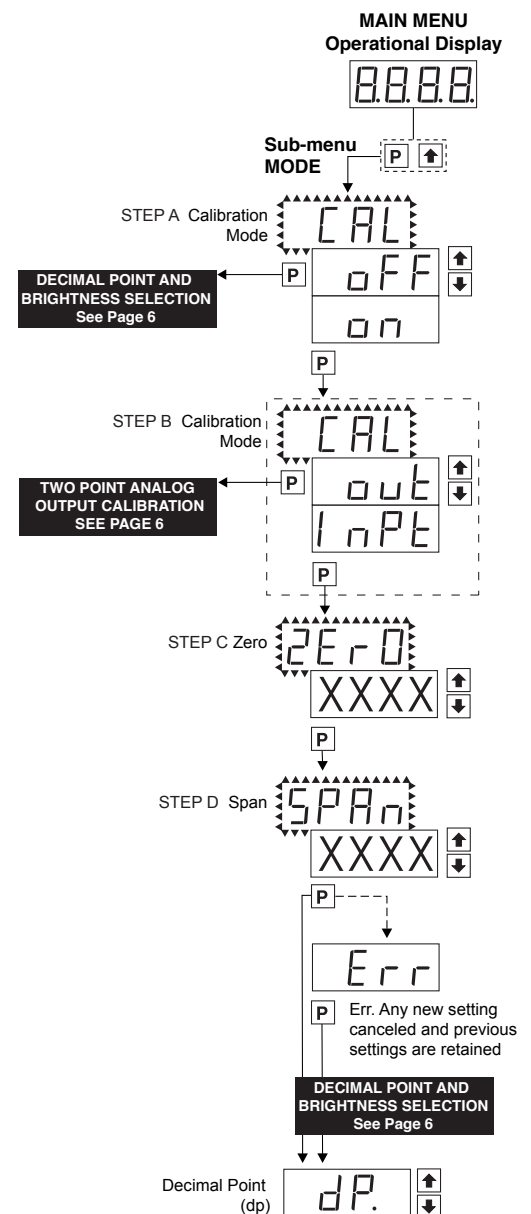

Two Point Analog Output Range Setting and Calibration

STEP A Enter the Calibration Mode

- 1) Press the **[P]** and **[↑]** buttons at the same time.
Display toggles between [CAL] and [oFF].
- 2) Press the **[↓]** or **[P]** button. Display changes from [oFF] to [on].
- 3) Press the **[P]** button. Display toggles between [CAL] and [out] input calibration.

Note: If at this point the display skips directly to toggle between [oFSt] (Manual) or [ZEro] (Auto) and the previous setting, the software is detecting that the optional analog output hardware is NOT installed.

STEP B Enter the Analog [oUT] Output Mode

- 1) Press the **[P]** button. Display toggles between [CLo] and an internal scale factor.

STEP C Set or Calibrate the [CLo] Low Analog Output Range

- 1) Select the voltage or current loop output header position on the output module. (See Component Layout on page 9).
- 2) Connect a multimeter to pins 16 and 17 on the output module. (See Rear Panel Pinouts on page 8). Using the **[↑]** and **[↓]** buttons, adjust the analog output to the desired low value as shown on the multimeter display. cLo may be adjusted to any value from -0.3 mA to 17 mA (mA output selected) or from -0.6 V to 8 V (volt output selected)
- 3) Press the **[P]** button. Display toggles between [CHi] and an internal scale factor.

STEP D Set or Calibrate the [CHi] High Analog Output Range

- 1) Using the **[↑]** and **[↓]** buttons, adjust the analog output to the desired high value as shown on the multimeter display. CHi may be adjusted to any value from 17 mA to 21 mA (mA output selected) or from 8 V to 10.3 V (volt output selected)
- 2) Press the **[P]** button. The display exits the calibration mode and returns to the operational display.

Note: Having established the Low and High range of the analog output, the digital span can now be selected which will set the two digital points between which the analog output will occur. (See Digital Span Selection below).

Decimal Point and Brightness Selection

STEP A Enter the Decimal Point and Brightness Mode Through the Sub Menu [CAL] [oFF]

- 1) Press the **[P]** and **[↑]** buttons at the same time.
Display toggles between [CAL] and [oFF].
- 2) Press the **[P]** button. Display shows previous [dP] selection.

STEP E Set the Decimal Point

- 1) Using the **[↑]** and **[↓]**, adjust the display to the desired decimal point setting.
- 2) Press the **[P]** button. Display toggles between [br] and the previous [br] setting.

STEP F Set the Display Brightness

- 1) Using the **[↑]** and **[↓]** buttons, adjust the display to the desired brightness setting (4 is the brightest setting).
- 2) Press the **[P]** button. Display brightness changes to new setting and display toggles between [AnHi] and the previous [AnHi] setting.

Digital Span Selection for Analog Range Output

STEP G Setting the Digital Span Point for Analog High Output

- 1) Using the **[↑]** and **[↓]** buttons, adjust the display to the desired digital value which sets the point at which the selected analog high output range will occur.
- 2) Press the **[P]** button. Display toggles between [AnLo] and previous [AnLo] setting.

STEP H Setting the Digital Span Point for Analog Low Output

- 1) Using the **[↑]** and **[↓]** buttons, adjust the display to the desired digital value which sets the point at which the selected analog low output range will occur.
- 2) Press the **[P]** button. The display exits the calibration mode and returns to the operational display.

Note: Any two digital scale points from -1999 to 9999 can be selected. The digital scale points for analog high and analog low can be reversed for reversed 20-4 mA output. The span of the digital scale can be as small as two counts however small spans cause the 16 bit D to A to increment in stair case steps.

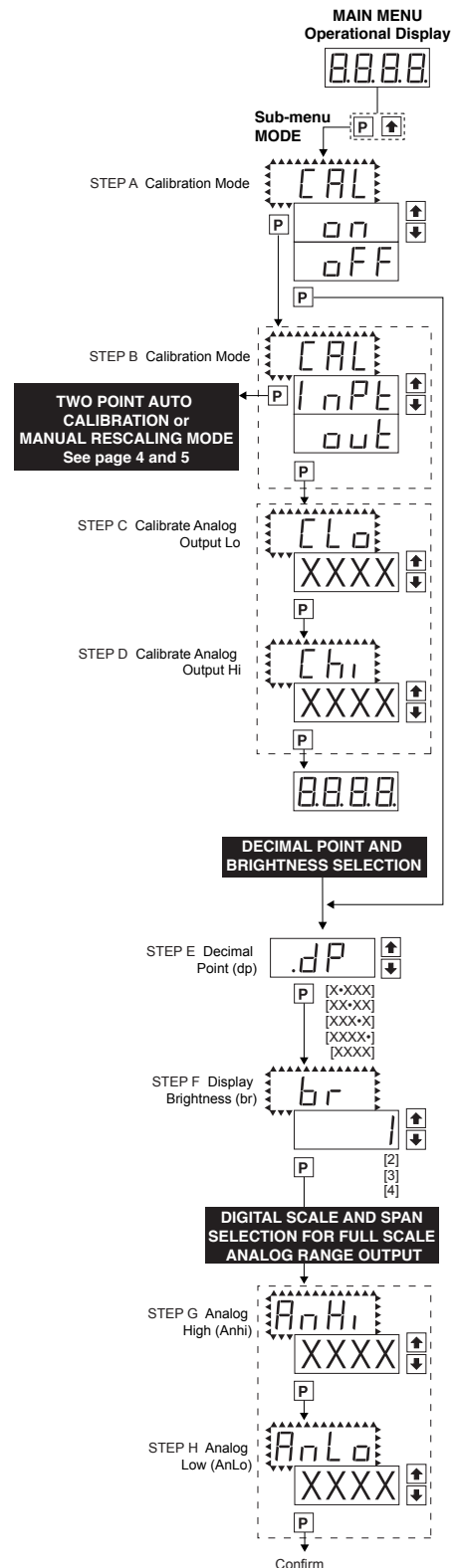

Modbus RTU & RS-485 Communication Settings

The Modbus/RS-485 communication settings sub-menu allows you to set the following parameters:

a) Baud Rate – this is the baud rate of the RS-485 serial communication between the meter (slave) and Modbus master. Options are 9600 (default, meter shows “96”) and 19200 (meter shows “192”).

b) Address – this is the meter’s Modbus address on the RS-485 loop. Typically, RS-485 limits the number of devices on the loop to 32, but the DL-40 supports the full Modbus address range of 1-247. Address 1 is the default value.

c) Parity – this is the parity setting for the RS-485 serial communication between the meter (slave) and Modbus master. Options are: None (display shows “0”); Odd (display shows “1”); Even (default, display shows “2”).

The meter’s response time to a read command from the master is 40-45msec (typically 42msec). The response time for a write command is 70-75msec (typically 72msec). This is due to the module having to communicate to the meter’s core firmware to complete the desired command. Exception responses are handled directly by the module and typically have a response time of 3msec.

Modbus RTU Implementation

The DL-40 Modbus communication module supports the following Modbus commands:

- a) Read Holding Register (0x03)
- b) Write Single Register (0x06)

Modbus addresses for DL-40JANUS registers are shown on the next page

The following are some things to note about particular registers:

- a) Modicon address 40001 RELAY has the bit values for Sp3 & Sp4 and LED3 & LED4 reversed. There is an historical reason for this, and we have chosen to maintain backward compatibility in case customer’s want to send their meters in for a Modbus upgrade (at a nominal fee).
- b) Modicon addresses 40002 INP, 40026 PEAK, 40027 VALY, 40029 ZERO, 40029 SPAN return a 2 byte hexadecimal value of the meter’s display (in counts) and does not include the decimal point. If you need the decimal value with decimal point, you will need to read the register, convert it to decimal, read 40024 (see below) to determine decimal location, then combine the two. Display counts are in Two’s Complement notation.
 - a. Hex values for 0 to 9999 are 0x0000 to 0x270F.
 - b. Hex values for -1 to -1999 are 0xFFFF to 0xF831.
 - c. Over-range is indicated by a returned value of 9999 (0x270F).
 - d. Under-range is indicated by a returned value of -1999 (0xF831).
- c) In order for Sp3 and Sp4 set point settings to work, the DL-40 must have the optional Output Carrier Board installed (P/N SA-DL/OM-CB).
- d) All Delay on Make (DoM), Delay on Break (DoB) and Hysteresis values are in units of whole seconds.

e) Modicon address 40023 RLYMOD uses the following values to set the relay activation mode (letter sequence is SP1, SP2, SP3, SP4):

- a. 0 for HHHH
- b. 1 for HLHL
- c. 2 for LHLH
- d. 3 for LLLL

e. H means relay is energized if input is equal to or exceeds setpoint; L means relay is energized if input is less than setpoint.

f. Note that the meter will not show the last two letters if the Output Carrier Board option is not installed.

f) Modicon address 40023 DP uses the following values to set the display decimal point location:

- a. 0 for XXXX (none)
- b. 1 for XXXX.
- c. 2 for XXX.X
- d. 3 for XX.XX
- e. 4 for X.XXX

g) Modicon address 40025 BRIGHT must be a value between 1 (most dim) to 4 (most bright).

h) Modicon addresses 40028 and 40029 will have different meanings depending on the Auto calibration or Manual rescaling operational selection (see Auto Calibration Mode or Manual Rescaling Mode above). These are explained in the register table below.

i) Modicon addresses 40030 IZERO and 40031 ISPAN return hexadecimal values related to the Auto Mode calibration of the meter. They do not necessarily match expected values due to variations and tolerances in the measurement circuit components, e.g., calibrating with a value of zero volts for the ZERO value may return a value of 0xFFFFE (-2). These registers have no meaning in Manual Rescaling Mode).

Modbus Addresses for DL-40 Registers

MODICON ADDRESS	MODICON ADDRESS	TYPE	R/W	MIN.	MAX.	Register	DESCRIPTION
40001	0x0000	UINT16	R	-	-	RELAY	B_0 SP1 Status B_1 SP2 Status B_3 SP4 Status B_2 SP3 Status B_4 LED1 Status B_5 LED2 Status B_7 LED4 Status B_6 LED3 Status
40002	0x0001	SINT16	R	-1999	9999	INP	Hexadecimal value of displayed value
40003	0x0002	UINT16	R	96/192	-	BAUD	Modbus baud rate stored as 96 for 9600 or 192 for 19200, set by user via menu interface.
40004	0x0003	UINT16	R	1	247	ADDR	Modbus meter address stored as a value between 1 - 247, set by user via menu interface.
40005	0x0004	UINT16	R	0	2	PARITY	Modbus parity value stored as a value of 0 (no parity), 1 (odd parity) or 2 (even parity), set by user via menu interface.
40011	0x000A	SINT16	R/W	-1999	9999	PRES1	Setpoint 1 setting
40012	0x000B	UINT16	R/W	0	9999	P1DOM	Setpoint 1 DoM setting
40013	0x000C	UINT16	R/W	0	9999	P1DOB	Setpoint 1 DoB setting
40014	0x000D	UINT16	R/W	0	9999	HYST1	Setpoint 1 Hysteresis setting
40015	0x000E	SINT16	R/W	-1999	9999	PRES2	Setpoint 2 setting
40016	0x000F	UINT16	R/W	0	9999	P2DOM	Setpoint 2 DoM setting
40017	0x0010	UINT16	R/W	0	9999	P2DOB	Setpoint 2 DoB setting
40018	0x0011	UINT16	R/W	0	9999	HYST2	Setpoint 2 Hysteresis setting
40019	0x0012	SINT16	R/W	-1999	9999	PRES3	Setpoint 3 setting
40020	0x0013	UINT16	R/W	0	9999	HYST3	Setpoint 3 Hysteresis setting
40021	0x0014	SINT16	R/W	-1999	9999	PRES4	Setpoint 4 setting
40022	0x0015	UINT16	R/W	0	9999	HYST4	Setpoint 4 Hysteresis setting
40023	0x0016	UINT16	R/W	0	3	RLYMOD	Relay activation polarity (H, L, disabled, e.g., HHHH)
40024	0x0017	UINT16	R/W	0	4	DP	Decimal Point setting
40025	0x0018	UINT16	R/W	1	4	BRIGHT	Brightness setting
40026	0x0019	UINT16	R/W	-	-	PEAK	Peak (maximum) measured value, writing any value resets this register
40027	0x001A	UINT16	R/W	-	-	VALY	Valley (minimum) measured value, writing any value resets this register
40028	0x001B	SINT16	R	-1999	9999	ZERO (Auto Mode Only)	Displayed value for the minimum input signal value that is applied during Auto Mode calibration
40029	0x001C	SINT16	R	-1999	9999	SPAN (Auto Mode Only)	Displayed value for the maximum input signal value that is applied during Auto Mode calibration
40028	0x001B	SINT16	R	-1999	9999	OFST (Manual Mode Only)	Displayed value for the Offset in Manual Rescaling Mode
40029	0x001C	SINT16	R	-1999	9999	SCAL (Manual Mode Only)	Displayed value for the Scale in Manual Rescaling Mode
40030	0x001D	UINT16	R	N/A	N/A	IZERO	Calibrated "zero" measurement for displayed ZERO in Auto Mode, has no meaning in Manual mode
40031	0x001E	UINT16	R	N/A	N/A	ISPAN	Calibrated "span" measurement for displayed maximum input SPAN in Auto Mode, has no meaning in Manual mode

Setpoint Setting and Relay Configuration Mode

The following programming steps are required to enter the setpoint values and configure the relay functions in a meter with four relays using four setpoints. Generally if less than four relays are installed the software auto detects missing relays and deletes reference to them from the menu. In some cases setpoints without relays are operational for display only purposes.

STEP A Enter the Setpoint Mode

- 1) Press the **[P]** and **[↓]** buttons at the same time.
Display toggles between [SP1] and the previous [SP1] setting.

STEP B Set Setpoint 1 (SP1)

- 1) Using the **[↑]** and **[↓]** buttons, adjust the display to the desired SP1 value.
- 2) Press the **[P]** button. Display toggles between [doM] and the previous [doM] setting.

STEP C Set the SP1 Delay-on-Make (doM) Delay Time Setting

- 1) Using the **[↑]** and **[↓]** buttons, adjust the display to the desired [doM] value (0 to 9999 seconds). The reading must continuously remain in an alarm condition until this delay time has elapsed before the relay will make contact (energize).
- 2) Press the **[P]** button. Display toggles between [dob] and the previous [dob] setting.

STEP D Set the SP1 Delay-on-Break (dob) Delay Time Setting

- 1) Using the **[↑]** and **[↓]** buttons, adjust the display to the desired [dob] value (0 to 9999 seconds). The reading must continuously remain in a non-alarm condition until this delay time has elapsed before the relay will break contact (de-energize).
- 2) Press the **[P]** button. Display toggles between [HYSt] and the previous [HYSt] setting.

STEP E Set the Hysteresis Setting for Setpoint 1

- 1) Using the **[↑]** and **[↓]** buttons, adjust the display to the desired hysteresis [hYSt] value.
 - 2) Press the **[P]** button. Display toggles between [SP2] and the previous [SP2] setting.
- NOTE:** Half of the Hysteresis value selected is applied above and below the setpoint.

NOTE: Steps F, G, H and J have functionally the same procedure as steps B, C, D, and E shown above.

STEP F Set Setpoint 2 (SP2)

STEP G Set the SP2 Delay-on-Make (doM) Delay Time Setting

STEP H Set the SP2 Delay-on-Break (dob) Delay Time Setting

STEP I Set the Hysteresis Setting for Setpoint 2

- 1) Using the **[↑]** and **[↓]** buttons, adjust the display to the desired hysteresis [HYSt] value.
- 2) Press the **[P]** button. Display toggles between [SP3] and the previous [SP4] setting.

STEP J Set Setpoint 3 (SP3) (No [doM] or [dob])

- 1) Using the **[↑]** and **[↓]** buttons, adjust the display to the desired SP3 value.
- 2) Press the **[P]** button. Display toggles between [HYSt] and the previous [HYSt] setting.

STEP K Set the Hysteresis Setting for Setpoint 3

- 1) Using the **[↑]** and **[↓]** buttons, adjust the display to the desired hysteresis [HYSt] value.
- 2) Press the **[P]** button. Display toggles between [SP4] and the previous [SP4] setting.

STEP L Set Setpoint 4 (SP4) (No [doM] or [dob])

- 1) Using the **[↑]** and **[↓]** buttons, adjust the display to the desired SP4 value.
- 2) Press the **[P]** button. Display toggles between [HYSt] and 0.

STEP M Set the Hysteresis Setting for Setpoint 4

- 1) Using the **[↑]** and **[↓]** buttons, adjust the display to the desired hysteresis [HYSt] value.
- 2) Press the **[P]** button. Display toggles between [rLYS] and the previous relay setting.

STEP N Set Relay Activation mode [rLYS]

(H) High the relay energizes when the setpoint is exceeded. (L) Low the relay energizes below the setpoint. The setpoint is indicated from left to right SP1, SP2, SP3, SP4.

- 1) Using the **[↑]** and **[↓]** buttons, adjust the reading on the display to the desired relay settings: [LLLL], [LHLH], [HLHL], [HHHH].

If only 2 relays installed [LH--], [HL--], [HH--], [LL--].

- 2) Press the **[P]** button.

The meter exits the setpoint mode and returns to the operational display.

The Setpoint Relay programming mode is now complete.

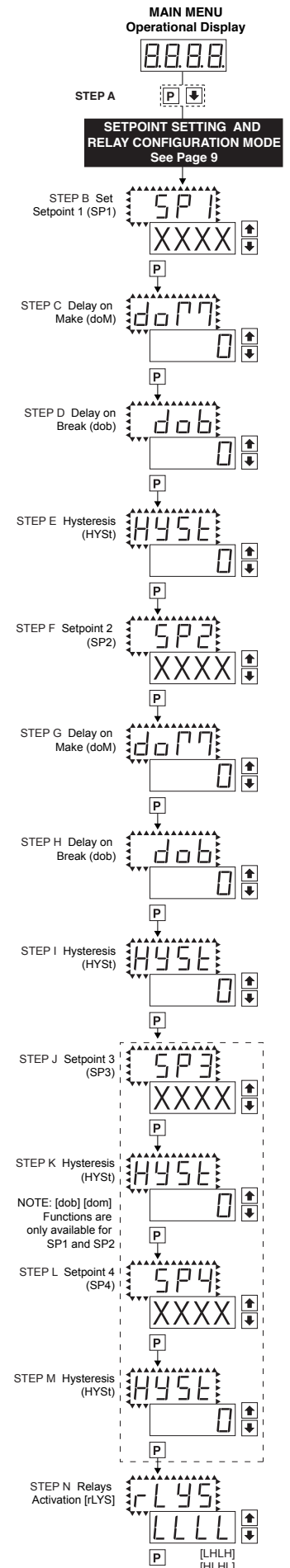

Pinout Diagram

The Rear View of the Meter diagram shows the meter with the relay configuration: dual 9 Amp Form C and dual 4 Amp Form A relays. An analog output module is also shown as installed.

The DL-40JANUS uses plug-in type screw terminal connectors for all input and output connections. The power supply connections (pins 14 and 15) have a unique plug and socket outline to prevent cross connection. The main board and input signal conditioner use right-angled connectors as standard. The output module uses straight-thru connectors as standard.



WARNING: AC and DC input signals and power supply voltages can be hazardous. Do Not connect live wires to screw terminal plugs, and do not insert, remove or handle screw terminal plugs with live wires connected.

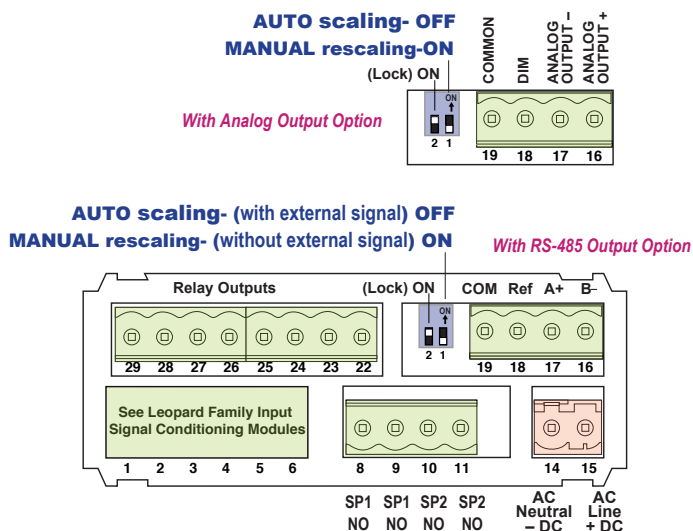

Auto-sensing AC/DC power supply. For voltages between 85-265 V AC / 95-370 V DC (PS1) or 18-48 V AC / 10-72 V DC (PS2).

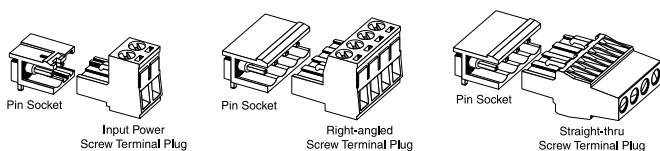

Standard plug-in screw terminal connectors provided by Texmate:

Input Signal – Pins 1 to 6

Pins 1 to 6 are reserved for the input signal conditioner. See the data sheet for the selected input signal conditioner.

Pins 8 to 12 – Relay Output Pins

Note: If relays for setpoints 1 & 2 are installed on the main board, and a relay output module is used that also has relays in the setpoints 1 & 2 positions, the duplicate relays will operate in unison.

Pin 8 SP1 NO.
Pin 9 SP1 NO. Normally Open 4 Amp Form A.
Pin 10 SP2 NO.
Pin 11 SP2 NO. Normally Open 4 Amp Form A.
Pin 12 NO CONNECTION.

Pins 14 and 15 – AC/DC Power Input

Auto-sensing AC/DC power supply. For voltages between 85-265 V AC/95-370 V DC (PS1) or 18-48 V AC/10-72 V DC (PS2).

Pin 14 AC/DC Neutral. Neutral power supply line.

Pin 15 AC/DC line. Live power supply line.

Analog and RS-485 Output Board Pins

Pins 16 and 17 – Analog Output

Pin 16 Positive (+) analog output.

Pin 17 Negative (-) analog output.

Pins 18 to 21 – Rear Panel Function Pins

Pins 18 to 21 provide functions that can be implemented with an external switch. Their pin definitions are:

Pin 18 **DIM.** By connecting the display dim (DIM) pin to the COMMON pin, the display brightness setting is halved.

Pin 19 **COMMON.** To activate the LOCK or DIM functions from the rear of the meter, the respective pins have to be connected to the COMMON pin. This pin is connected to the internal power supply ground.

Switch 1 **AUTO/MANUAL SCALING Mode.** When switch 1 is set to ON position, the Manual Scaling is selected. When switch 1 is set to OFF, the Auto Scaling is selected, and this is the default position.

Switch 2 **LOCK.** By setting the LOCK pin to the ON position, the meter's programmed parameters can be viewed but not changed.

Meter Assembly

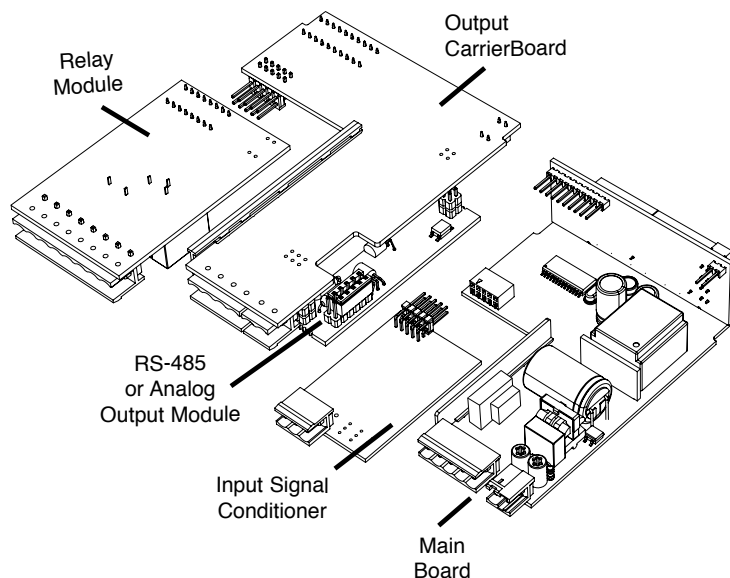

Pins 22 to 29 – Relay Output Module Pins

Relay Modules with 2 Non-Isolated 4A Form A Relays, and 2 Non-Isolated 9A Form C Relays

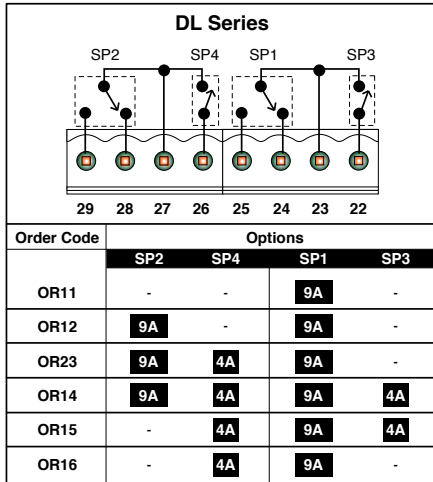

Relay Modules with 4 Isolated 4A Form A Relays

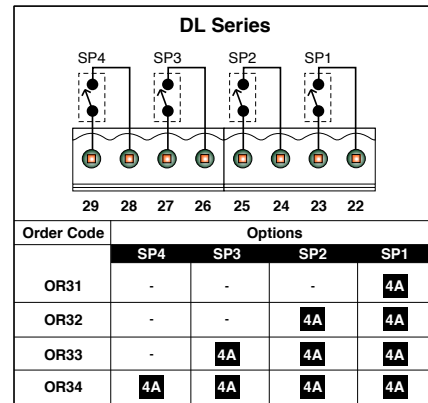

Relay Modules with 4 Independent 400V 210mA DC only SSRs

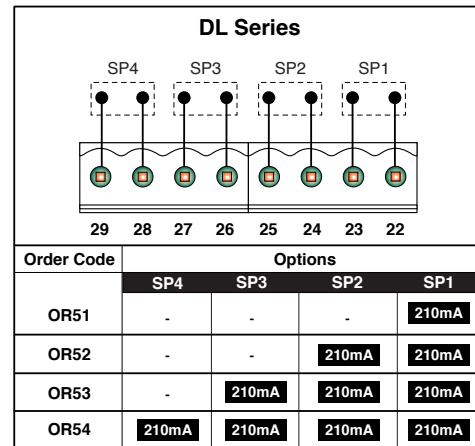

Installation Guidelines

Installation

1. Install and wire meter per local applicable codes/regulations, the particular application, and good installation practices.
2. Install meter in a location that does not exceed the maximum operating temperature and that provides good air circulation.
3. Separate input/output leads from power lines to protect the meter from external noise. Input/output leads should be routed as far away as possible from contactors, control relays, transformers and other noisy components. Shielding cables for input/output leads is recommended with shield connection to earth ground near the meter preferred.
4. A circuit breaker or disconnect switch is required to disconnect power to the meter. The breaker/switch should be in close proximity to the meter and marked as the disconnecting device for the meter or meter circuit. The circuit breaker or wall switch must be rated for the applied voltage (e.g., 120VAC or 240VAC) and current appropriate for the electrical application (e.g., 15A or 20A).

5. See *Case Dimensions* section for panel cutout information.
6. See *Connector Pinouts* section for wiring.
7. Use 28-12 AWG wiring, minimum 90°C (HH) temperature rating. Strip wire approximately 0.3 in. (7-8 mm).
8. Recommended torque on all terminal plug screws is 4.5 lb-in (0.51 N-m).

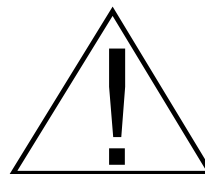

I-Series Input Signal Conditioning Modules









Many additional input modules are available and others are constantly being developed. Check with your local distributor or www.texmate.com for updated information.

Pre-calibrated **I-Series** input modules, that have span or zero potentiometers, can be interchanged between any **I-Series** compatible meter, without recalibration, because all of the analog scaling and reference circuitry is self-contained within the module. Where appropriate, all the standard ranges shown are designed to be header selectable by the user, and Texmate's unique

SPAN ADJUST Header facilitates scaling to almost any required engineering unit. See Input Module Component Glossary and Calibration on pages 14 and 15. Also see Manual Rescaling on page 4 and Auto Calibration on page 5.

Unless otherwise specified Texmate will ship all modules pre-calibrated with factory preselected ranges and/or scalings as shown in **BOLD** type. Other pre-calibrated standard ranges or custom ranges may be ordered. Factory installed custom scaling and other custom options are also available (see Ordering Information, Special Options on last page).

Symbols Indicate Module Compatibility Within Meter Families

 TIGER Family	 LEOPARD Family	 LYNX Family
 LEOPARD Family	 LYNX Family	 TIGER Family
 LYNX Family	 TIGER Family	 LEOPARD Family
ALL MODELS	SOME MODELS	MODEL SPECIFIC



WARNING: AC and DC input signals and power supply voltages can be hazardous. Do Not insert, remove or handle modules with live wires connected to any terminal plugs.

IA06: AC Volts True RMS, 300/600V AC

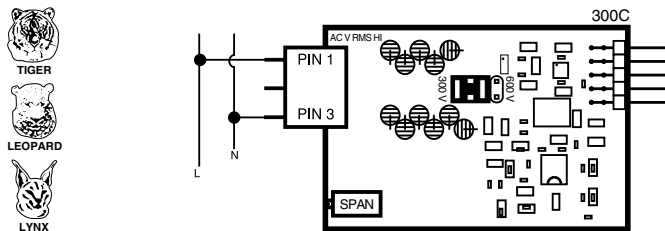

ID01: DC Volts, 2/20/200V/Custom w/24V DC Exc

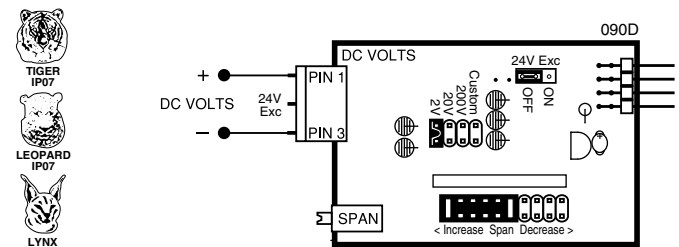

IA07: AC Volts True RMS, 200mV/2V/20V AC

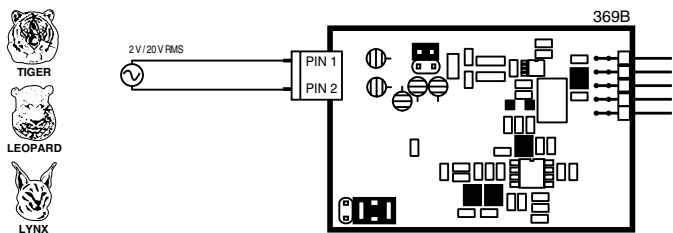

ID02: DC Millivolts, 20/50/100/200mV DC w/24V DC Exc

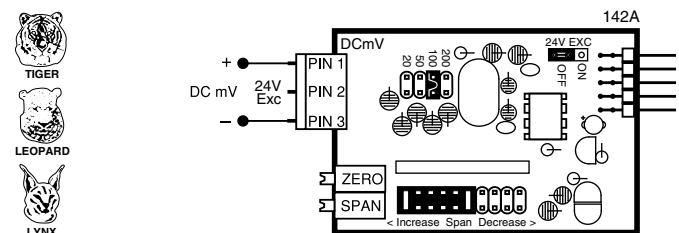

IA08: AC Milliamps True RMS, 2/20/200mA AC

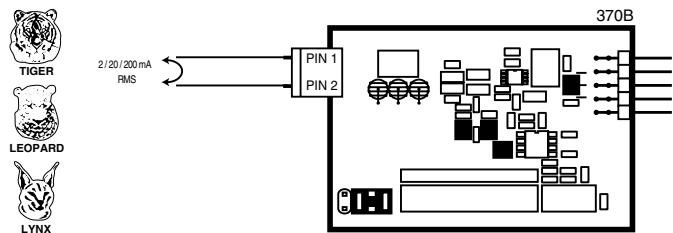

ID03: DC Milliamps, 2/20/200mA DC w/24V DC Exc

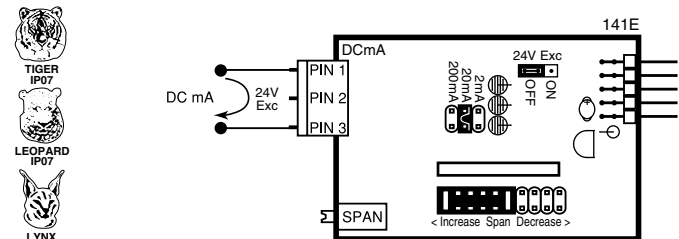

IA09: AC Amps True RMS, 1 Amp AC

IA11: AC Amps True RMS, 5 Amp AC

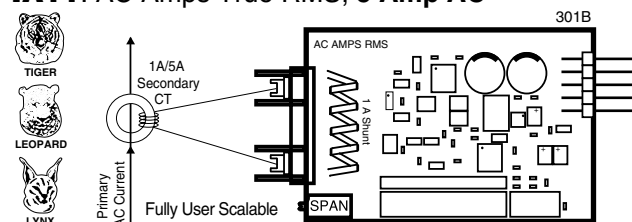

ID04: DC Amps, 5A DC

ID09: DC Amps, 1A DC

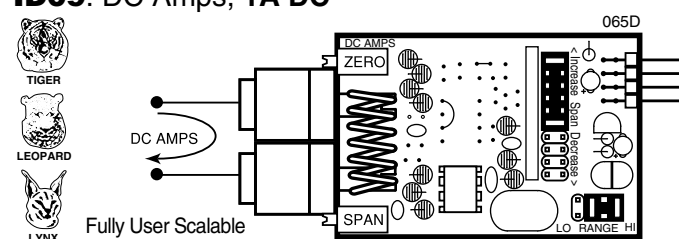

I-Series Input Signal Conditioning Modules

ID05: DC Volts 2/20/200/Custom V DC with Offset and 24V Exc.

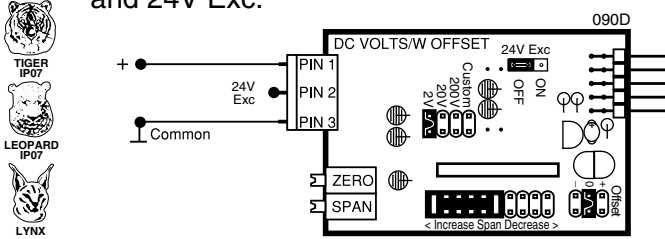

ID07: DC Milliamps, 2/20/200mA DC with Offset and 24V Exc

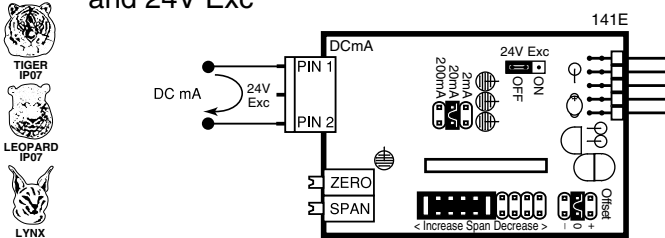

IF02: Line Frequency

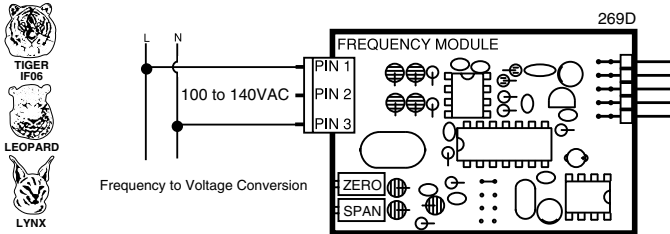

IGYZ: Universal Direct Pressure (Absolute or Differential/Gage) See below for ordering code options

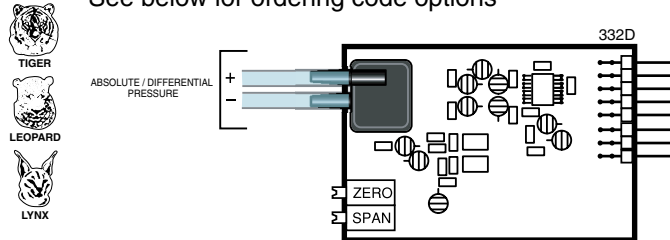

Direct Pressure (IGYX, IGY & IGYZ) Ordering Code Options

I G → For Single Channel IGYX with two digital inputs, the last digit of order code is always X.

Sensor Range	CH1 Order Code	CH2 Order Code
1 psi Absolute	A	A
1 psi Differential	B	B
5 psi Absolute	C	C
5 psi Differential	D	D
15 psi Absolute	E	E
15 psi Differential	F	F
30 psi Absolute	G	G
30 psi Differential	H	H
100 psi Absolute	J	J
100 psi Differential	K	K

For Universal Direct Pressure IGYZ, the last digit of order code is always Z.

IP01: Process Loop, 4-20mA
IP02: Process Loop, 4-20mA with 24VDC EXC

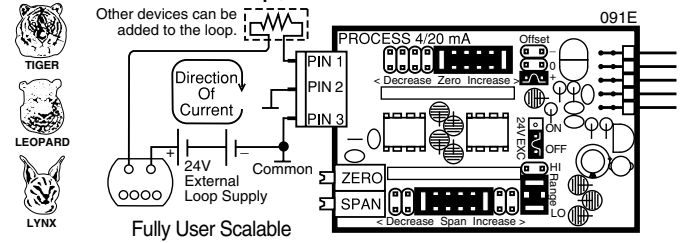

IP03: Process Input, 1-5V DC with Offset, 24V Exc

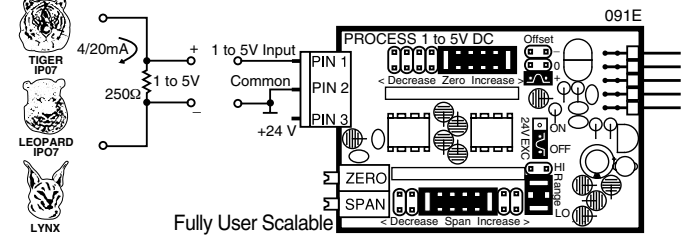

IP07: Universal Process Input
2V/5V/10V/20V/200V/2mA/20mA/Custom

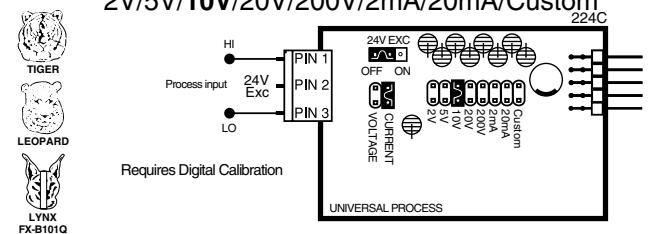

IR02: 3 wire Potentiometer 1KΩ min (0-F.S.)

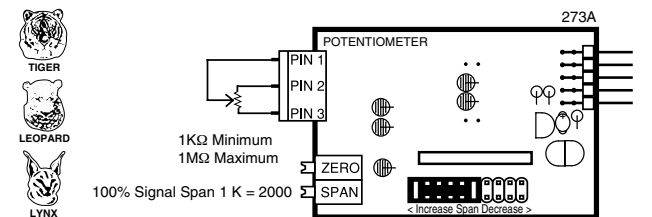

IR03: Linear Potentiometer 1KΩ min

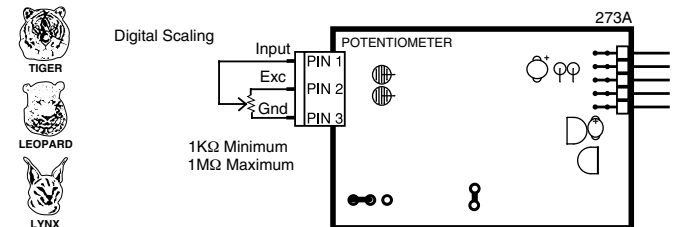

IR04: Resistance 2KΩ (Lynx only)
IR05: Resistance 2KΩ (Leopard only)

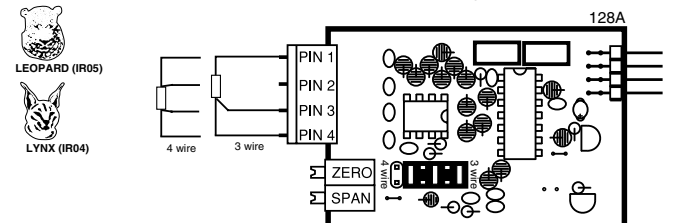

I-Series Input Signal Conditioning Modules

IS01: Strain Gage 5/10VDC Exc., 20/2mV/V, 4/6-wire

IS02: Pressure/Load Cell 5/10VDC Exc., 20/2mV/V, 4/6-wire

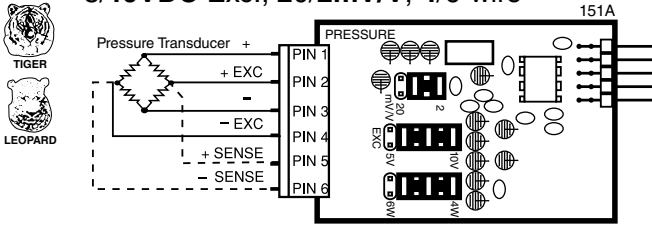

IS04: Pressure/Load Cell Ext Exc., 20/2mV/V, 4/6-wire

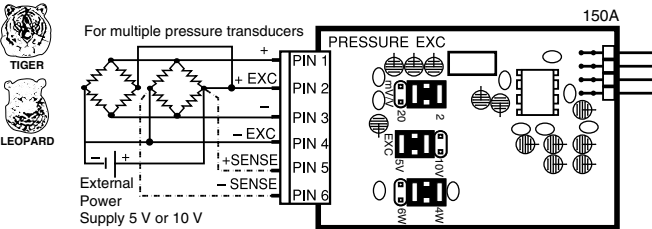

IS05: Pressure/Load Cell 20/2mV/V, 5/10V Exc 4-wire

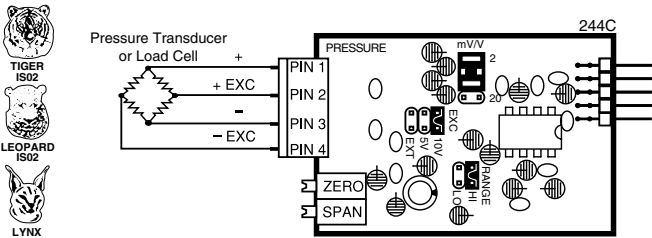

IS06: Pressure/Load Cell Ext Exc., 20/2mV/V, 4-wire

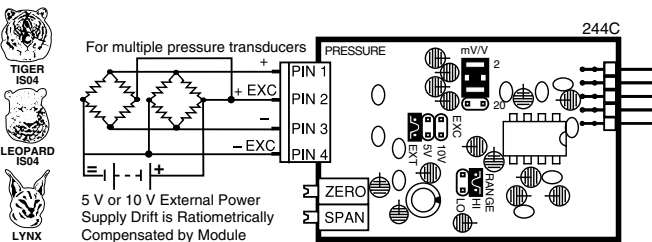

IT03: RTD, 100Ω Pt. 2/3/4-wire (-200 to 800°C)

IT04: RTD, 100Ω Pt. 2/3/4-wire (-200 to 1470°F)

IT05: RTD, 100Ω Pt. 2/3/4-wire (-199.9 to 199.9°F)

IT14: RTD, 100Ω Pt. 2/3/4-wire (-199.9 to 199.9°C)

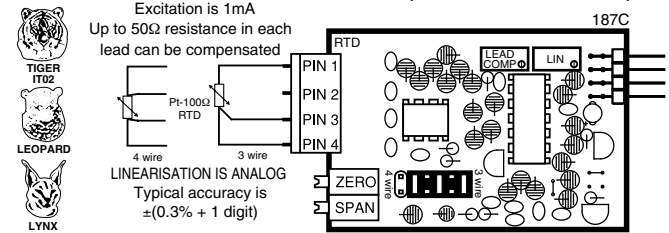

IT06: Thermocouple, J Type (0-1400 F)

IT08: Thermocouple, J Type (0-760 C)

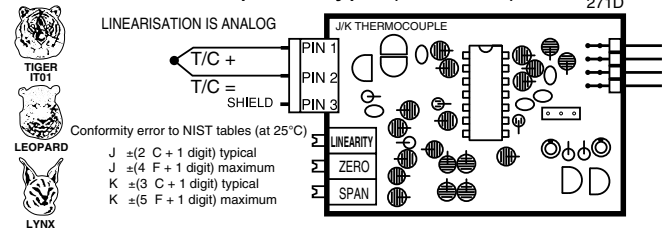

IT07: Thermocouple, K Type (0-1999 °F)

IT09: Thermocouple, K Type (0-1260 °C)

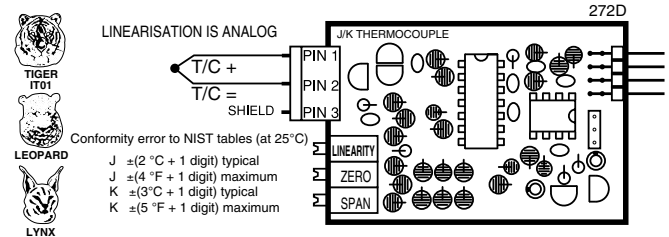

For higher accuracy digitally linearized RTD (P385 or P392) and Thermocouples (J/K/R and T), see the special Leopard Temperature meters DL-40-RTD and DL-40-RTD which use only two special thermocouple modules which are not compatible with regular Leopard Family meters.

IT-10 Thermocouple J/K/R/T, °C/°F, 1°/0.1° resolution
User Selectable Accuracy ±0.05% + 2 digits.

IT-11 RTD 100Ω Pt, 3/4 wire, °C/°F, 1°/0.1° resolution
User Selectable Accuracy ±0.05% + 2 digits.

Input Module Component Glossary

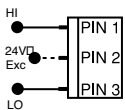

Input and Output Pins

On most modules Pin 1 is the Signal High input and Pin 3 is the Signal Low input. Typically Pin 2 is used for Excitation Voltage output.



24V DC Output Header

On some modules this header enables a 24V DC 25mA (max) Excitation/Auxiliary output to be connected to Pin 2.

INPUT RANGE Header

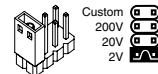

Range values are marked on the PCB. Typically two to four positions are provided, which are selected with either a single or multiple jumper clip. When provided, a custom range position is only functional when the option has been factory installed.

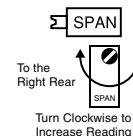

SPAN Potentiometer (Pot)

If provided, the 15 turn SPAN pot is always on the right side (as viewed from the rear of the meter). Typical adjustment is 20% of the input signal range.

SPAN ADJUST Header

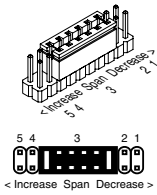

This unique five-position header expands the adjustment range of the SPAN pot into five equal 20% steps, across 100% of the input Signal Span. Any input Signal Span can then be precisely scaled down to provide any required Digital Display span from 1999 counts to 001 (one count).

SPAN Adjust Header position	1	2	3	4	5
SPAN Pot %	20%	20%	20%	20%	20%
Signal Span %	20%	40%	60%	80%	100%



SPAN RANGE Header

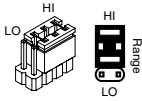

When this header is provided it works in conjunction with the SPAN ADJUST Header by splitting its adjustment range into a Hi and a Lo range. This has the effect of dividing the adjustment range of the SPAN pot into ten equal 10% steps across 100% of the input Signal Span.

SPAN Adjust Header position	1	2	3	4	5	1	2	3	4	5
SPAN Pot %	10%	10%	10%	10%	10%	10%	10%	10%	10%	10%
Signal Span %	10%	20%	30%	40%	50%	60%	70%	80%	90%	100%

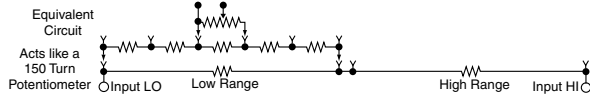

ZERO Potentiometer (Pot)

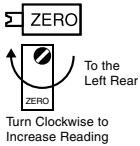

If provided, the ZERO pot is always to the left of the SPAN pot (as viewed from the rear of the meter). Typically it enables the input signal to be offset $\pm 5\%$ of full scale (-100 to +100 counts).

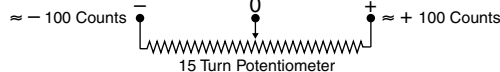

Input Module Calibration Examples

IA06 AC-Volts True RMS, 200/600V AC

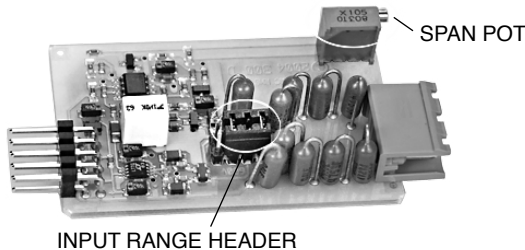

IA11 AC-Amps True RMS

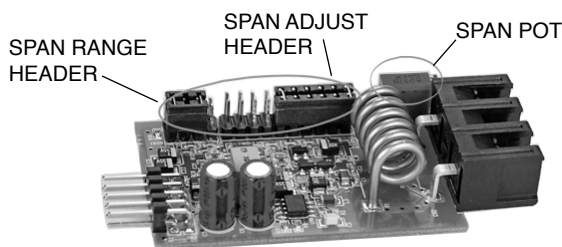

ZERO OFFSET RANGE Header

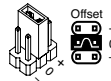

When provided, this three position header increases the ZERO pot's capability to offset the input signal, to $\pm 25\%$ of the digital display span. For example a Negative offset enables a 1 to 5V input to display 0 to full scale. The user can select negative offset, positive offset, or no offset (ZERO pot disabled for two step non-interactive span and offset calibration).

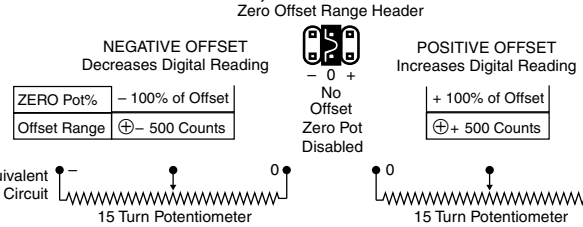

ZERO ADJUST Header

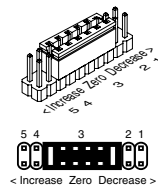

When this header is provided, it works in conjunction with the ZERO OFFSET RANGE Header, and expands the ZERO pot's offset capability into five equal negative steps or five equal positive steps. This enables virtually any degree of input signal offset required to display any desired engineering unit of measure.

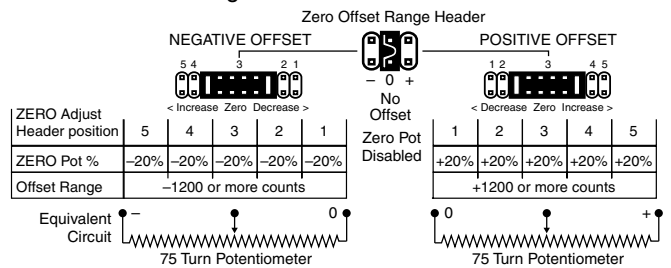

Input Module Analog Calibration

In addition to the analog calibration capabilities that enable many modules to be interchanged between different meters without loss of accuracy the Leopard Family of meters have enhanced Digital Calibration functions. See Page 4-5.

Basic standard range calibration of direct reading modules that utilize either Auto Zero or a ZERO pot, an INPUT RANGE Header and or a SPAN pot.

- 1 If the module has an INPUT RANGE Header, reposition the jumper clip to select the desired input signal range.
2. Apply a zero input or short the input pins. The display will auto zero, or if the module has a ZERO pot, it should be adjusted until the display reads zero.
- 3 Apply a known input signal that is at least 20% of the full scale input range and adjust the SPAN pot until the display reads the exact input value. For negative inputs, Leopard Family Meters will display negative overrange at 50% of full scale range.
- 4 Decimal Points. The selection or positioning of decimal points has no effect on the calibration of the modules

Wide range scaling, in engineering units not requiring offsets, with modules that utilize auto-zero or a ZERO pot, a SPAN RANGE Header and or a SPAN ADJUST Header.

Texmate's unique SPAN ADJUST and SPAN RANGE Headers provide the circuit equivalent of an ultra-precision one megohm 75 or 150 turn potentiometer that can infinitely scale down any Input Signal SPAN to provide any full scale Digital Display Span from 1999 (counts) to 001 (one count).

Input Module Calibration Procedures Continued

If the module has an INPUT RANGE Header, and the required full scale Digital Display Span (counts) is to be larger than the directly measured value of the input Signal Span, then the next lower range on the INPUT RANGE Header should be selected. The resulting over range Signal Span is then scaled down, by selecting the position of the SPAN RANGE Header and or the SPAN ADJUST Header, which will reduce the input Signal Span to a percentage, that the required Digital Display Span can be reached by calibration with the SPAN pot.

Example A: 0 to 10 V to read 0 to 1800 gallons.

Signal Span = 10V, Digital Display Span = 1800 counts

- 1 Select the 2 V INPUT RANGE Header position. This will provide a digital display of 1800 counts with an input of only 1.8 V which is $(1.8 \div 10) = 18\%$ of the examples 10 V Signal Span.
- 2 To scale down the Signal Span to 18% select the 20% Signal Span position on the SPAN ADJUST Header (position 1) or if the module has a SPAN RANGE Header, select (LO Range) and 20% Signal Span position on the SPAN ADJUST Header (position 2).
- 3 Apply a zero input or short the input pins. The display will auto zero, or if the module has a ZERO pot, it should be adjusted until the display reads zero.
- 4 Apply 10 V and adjust the SPAN pot until the display reads 1800.

Large offset scaling and calibration of process signal inputs with modules that utilize ZERO ADJUST Headers and or ZERO OFFSET RANGE Headers.

Texmate's unique ZERO OFFSET RANGE Header enables the use of a simple two step scaling and calibration procedure for those process signals that require large offsets. This eliminates the back and forth interaction, between zero and span settings, that is often required to calibrate less finely engineered products.

The first step is to set the ZERO OFFSET RANGE Header to the center position (No Offset) and scale down the Input Signal Span to a percentage that will enable calibration with the SPAN pot to reach the required Digital Display Span.

The second step is to set the ZERO ADJUST and or ZERO OFFSET RANGE Header to provide a positive or negative offset of sufficient counts that calibration with the ZERO pot will offset the Digital Display Span to produce the required digital reading.
Example B: 1 to 5 V to read -100 to 1500 °C.

Signal Span = 4V, Digital Display Span = 1600 counts

- 1 If the module has an INPUT RANGE Header the 2 V position should be selected. This will provide a digital display of 1600 counts for an input of 1.6 V which is $(1.6 \div 4) = 40\%$ of the examples 4 V signal span. To scale down the Signal Span to 40% select the 40% Signal Span position on the SPAN ADJUST Header (position 2).
- 2 If the module is a Process Input 1-5 V DC type, select the (Hi Range) position on the SPAN RANGE Header and the 100% Signal Span position on the SPAN ADJUST Header (position 5, max increase). This will provide a digital display of 1600 counts for an input of 4V which is 100% of the examples 4V Signal Span.
- 3 Set the ZERO OFFSET RANGE Header to the center position (no offset). Apply 1 V and adjust the SPAN pot until the display reads 400 . A 4V input would then read 1600 counts.
- 4 Set the ZERO OFFSET RANGE Header to the negative offset position. If the module has a ZERO ADJUST Header select the position that will provide a negative offset of ≈ -500 counts. Apply 1 V and adjust the ZERO pot until the display reads -100. Apply 5 V and check that the display reads 1500.

Example C: 4 to 20 mA to read 00.0 to +100.0%

Signal Span = 16 mA, Digital Display Span = 1000 counts.

- 1 The full scale Signal Span of the Process Input 4-20 mA modules is 0 to 20 mA for a full scale Digital Display Span of 0 to 2000 counts. This will provide a digital display of 1000 counts with an input of only 10 mA which is $(10 \div 16) = 62.5\%$ of the examples 16 mA signal span.
- 2 To scale down the Signal Span to 62.5% select the (Hi Range) Position on the Span Range Header and the 70% Signal Span position on the SPAN ADJUST Header (position 2).
- 3 Set the ZERO OFFSET RANGE Header to the center position (no offset). Apply 4 mA and adjust the SPAN pot until the display reads 250 . A 16 mA input would then read 1000 counts.
- 4 Set the ZERO OFFSET RANGE Header to the positive offset position. If the module has a ZERO ADJUST Header select the position that will provide a negative offset of ≈ -250 counts. Apply 4 mA and adjust the ZERO pot until the display reads 000. Apply 20 mA and check that the display reads 1000. Select decimal point XXX.X to display 00.0 to 100.0.

Case Dimensions

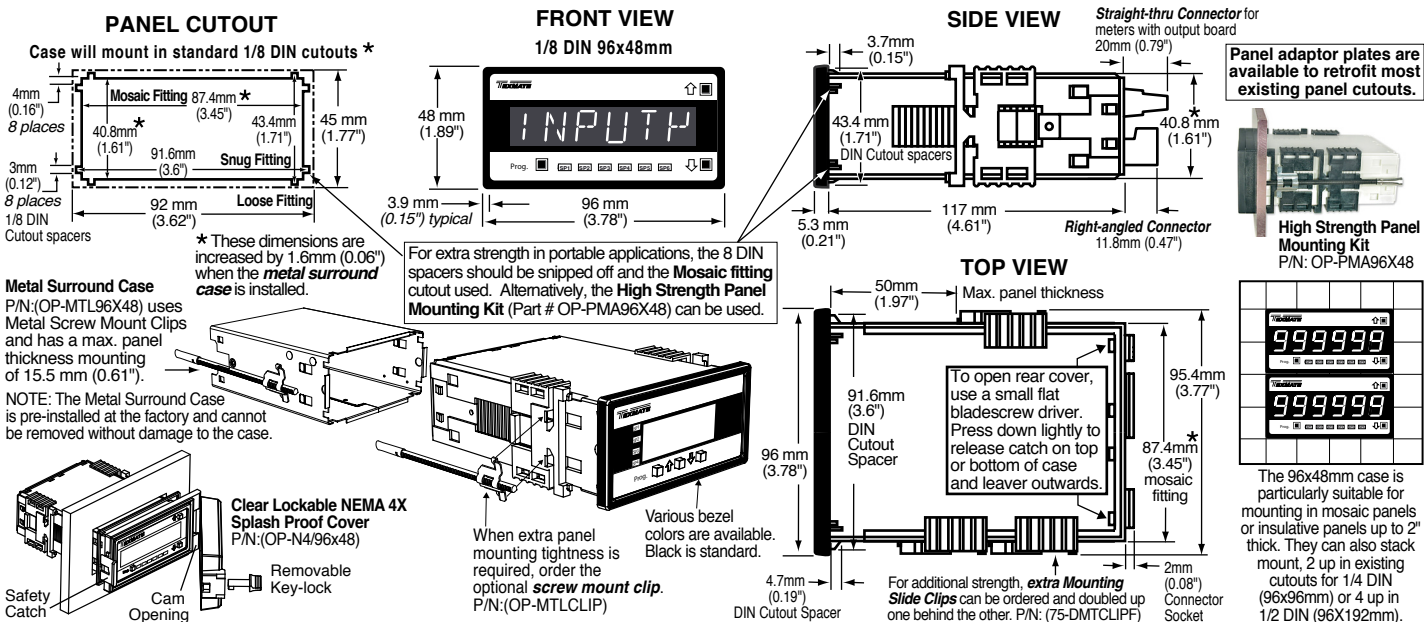

Clear Lockable Water-proof Lens Cover OP-N4X/96X48

Clear Lockable NEMA 4X Dust and Splash Proof Cover PN: OP-N4/96x48



The clear lockable cover is designed to be dust and water proof to NEMA-4X, IP65 standards. The assembly consists of a base and cover with a cam hinge and key-lock fastening mechanism. An O-ring, or neoprene gasket forms a seal between the base and the panel. The cam hinge prevents the cover from closing when opened until pushed closed. The cover has a tapered recess that, when closed, forms a seal with a tapered spigot on the base. A key-lock employs a cam locking device to force the spigot into the recess, ensuring seal integrity. A safety catch keeps the cover closed even when the key is removed, and the keyhole can be used to attach a safety seal clip, preventing unauthorized opening.

Metal Surround Case Option OP-MTL96X48

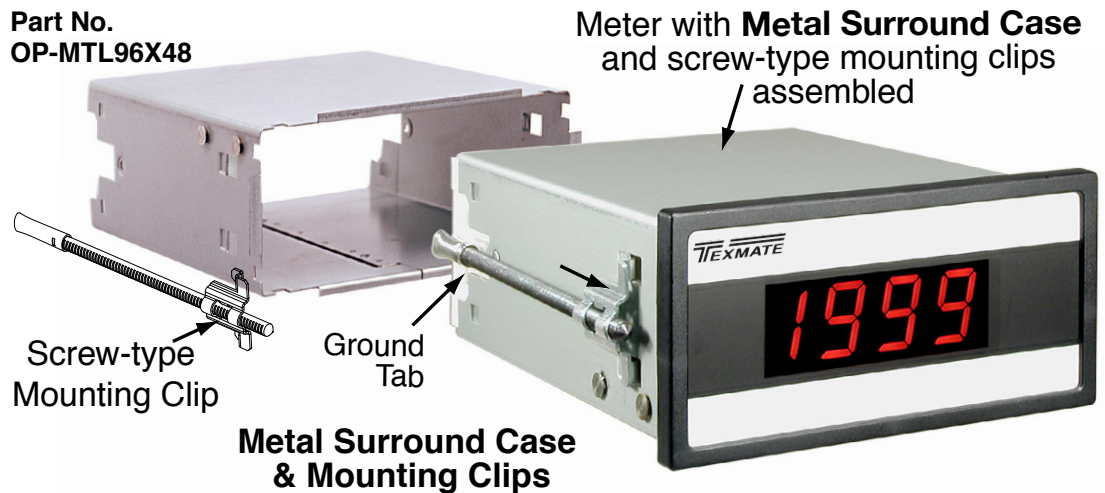

The meter's plastic case is made from fire retardant polycarbonate. A metal surround case can be ordered to enhance the meter's fire retardant capabilities and also provide shielding against electromagnetic interference (EMI). The metal case slides over the polycarbonate case and is held firmly in place by spring-type non-return clips. The Metal Surround Case must be factory installed on the polycarbonate case and once installed, it cannot be removed in the field.

With the metal case in place, the meter's standard ratchet-type mounting clips can not be used. Instead a pair of screw-type DIN standard mounting clips are provided, which clip into holes on the side of the metal case and tighten against the rear of the panel. A ground tab on the metal case enables the metal case to be easily connected to the panel ground.

Ordering Information

BASIC MODEL # **DISPLAY** **POWER SUPPLY** **INPUT MODULES** **ANALOG OUTPUT*** **RELAY OUTPUT*** **OPTIONS / ACCESSORIES**

DL-40JANUS — — — — — — — **OA**

Add to the basic model number the order code suffix for each standard option required. The last suffix is to indicate how many different special options and or accessories that you may require to be included with this product. Please see our website, www.texmate.com to configure a meter and see current pricing.

► BASIC MODEL NUMBER

DL-40JANUS . . .96x48, Leopard, 4 Digit

Standard Options for this Model Number

Order Code Suffix Description

► DISPLAY

- DR** Red LED, 0.56 inch high
- DB** Super-bright Red LED, 0.56 inch high
- DG** Green LED, 0.56 inch high
- LG** Large Green LED, 0.8 inch high
- LR** Large Red LED, 0.8 inch high

► POWER SUPPLY

- PS1** **.85 - 265VAC / 95 - 370VDC**
- PS2** 18 - 48VAC / 10 - 72VDC

► INPUT MODULES (Partial List. See www.texmate.com)

Unless otherwise specified Texmate will ship all modules precalibrated with factory preselected ranges and/or scalings as shown in **BOLD** type

- IA06** . . AC-Volts True RMS, 200/**600V AC**
- IA07** . . AC-Volts True RMS, 200mV/**2V/20V AC**
- IA08** . . AC-mA True RMS, **2/20/200mA AC**
- IA09** . . AC-Amps True RMS, **0-1 Amp AC (0-100.00)**
- IA11** . . AC-Amps True RMS, **0-5 Amp AC (0-100.00)**
- ID01** . . DC-Volts, **2/20/200V/Custom w/24V DC Exc.**
- ID02** . . DC-Millivolt, **20/50/100/200mV DC w/24V DC Exc**
- ID03** . . DC-Milliamp, **2/20/200mA DC w/24V DC Exc**
- ID04** . . DC-Amps, **5A DC**
- ID05** . . DC-Volts **2/20/200/Custom V DC w/Offset and 24V Exc.**
- ID07** . . DC-Milliamp, **2/20/200mA DC w/Offset and 24V Exc**
- ID09** . . DC-Amps, **1A DC**
- IF02** . . Line Frequency, 50-500VAC, 199.9Hz, or optional 400Hz
- IGYZ*** . . Universal Direct Pressure
- *View the **IG-Ordering Code** on page 13 to determine the value for Y & Z (IGAZ to IGKZ)
- IP01** . . Process Loop, **4-20mA(0-100.00)**
- IP02** . . Process Loop, **4-20mA(0-100.00)** w/24VDC Exc
- IP03** . . Process Input, **1-5V DC(0-100.00)** w/Offset, 24V Exc.
- IP07** . . Universal Process **2V/5V/10V/20V/200V/2mA/20mA/Custom**
- \$**
- IP01** . . Prototype Board for Custom Design
- IR02** . . 3-Wire Potentiometer 1KΩ min (0-F.S.)
- IR03** . . Linear Potentiometer, 3-wire, 1KΩ min
- IR05** . . Resistance 2KΩ
- IS01** . . Strain Gage 5/10VDC Exc., 20/2mV/V, 4/6-wire
- IS02** . . Pressure 5/10VDC Exc., 20/2mV/V, 4/6-wire
- IS04** . . Pressure Ext Exc., 20/2mV/V, 4/6-wire
- IS05** . . Pressure/Load Cell 20/2mV/V, 5/10V Exc 4-wire
- IS06** . . Pressure/Load Cell Ext Exc., 20/2mV/V, 4-wire

► ANALOG OUTPUT

- AIV** Isolated 14 Bit Voltage Output, 0-10VDC
- AIC** Isolated 14 Bit Current Output, 0-20mA and 4-20mA, pls. specify

► MODBUS RTU RS-485 SERIAL OUTPUT

S485 . . Isolated Modbus RTU RS-485 serial output

► RELAY OUTPUT

Note: R1 and R2 are located on the main board, and are generally used when only two Form A Relays or less are required and an Analogy Output is not required.

- R1** Single 5A Form A Relay
- R2** Dual 5A Form A Relays

► RELAY OUTPUT MODULES

- OR11** . . One 9 Amp Form C Relay, Isolated
- OR15** . . One 9 Amp Form C and Two 4 Amps Form A Relays
- OR16** . . One 9 Amp Form C and One 4 Amp Form A Relays
- OR12** . . Two 9 Amp Form C Relays, Isolated
- OR14** . . Two 9 Amp Form C and Two 4 Amps Form A Relays
- OR23** . . Two 9 Amp Form C and One 4 Amp Form A Relay, Isolated
- OR31** . . One 4 Amp Form A Relay, Isolated
- OR32** . . Two 4 Amp Form A Relays, Isolated
- OR33** . . Three 4 Amp Form A Relays, Isolated
- OR34** . . Four 4 Amp Form A Relays, Isolated

Solid State Relay (SSR) Output Modules DC Only

- OR51** . . One 400V DC Solid State Relay (SSR) 210mA
- OR52** . . Two 400V DC Solid State Relays (SSR) 210mA
- OR53** . . Three 400V DC Solid State Relays (SSR) 210mA
- OR54** . . Four 400V DC Solid State Relays (SSR) 210mA

Special Options and Accessories (OA's)

Part Number Description

► SPECIAL OPTIONS (Specify Inputs or Outputs & Req. Reading)

- SA-DL/OM-CB** Output Module Carrier Board, DL series
- ZR** Range Change from Standard Range shown in **BOLD** type
- ZS** Custom display scaling within standard ranges
- ZS-AO** Custom scaling of analog output for digital meters & bargraphs.

► ACCESSORIES (Specify Serial # for Custom Artwork Installation)

- 75-DBBZ9648F** Black Bezel for 96x48mm Case
- 75-DMTCLIPF** Side Slide Brackets (2 pc) - extra set, extra strength
- 76-DL40G-N4** "Touch" Green LED Faceplate, NEMA 4, Factory install
- 76-DL40LG-N4** "Touch" Large Green LED Faceplate, NEMA 4, Factory install
- 76-DL40LR-N4** "Touch" Large Red LED Faceplate, NEMA 4, Factory install
- 76-DL40R-N4** "Touch" Red LED Faceplate, NEMA 4, Factory install
- ART-FS-S/D**NRC for artwork & set-up Faceplate/Desc.
- ART-FS-001**Install Custom Faceplate per meter - 1 color
- OP-MTLCLIP**Screw Mounting Clips (2 pc) - to screw tighten slide brackets
- OP-MTL96X48** Metal Surround Case, includes screw mounting clips
- OP-N4X/96X48**96x48mm clear lockable front cover-NEMA 4X, splash proof

Prices subject to change without notice.

WARRANTY

Texmate warrants that its products are free from defects in material and workmanship under normal use and service for a period of one year from date of shipment. Texmate's obligations under this warranty are limited to replacement or repair, at its option, at its factory, of any of the products which shall, within the applicable period after shipment, be returned to Texmate's facility, transportation charges pre-paid, and which are, after examination, disclosed to the satisfaction of Texmate to be thus defective. The warranty shall not apply to any equipment which shall have been repaired or altered, except by Texmate, or which shall have been subjected to misuse, negligence, or accident. In no case shall Texmate's liability exceed the original purchase price. The aforementioned provisions do not extend the original warranty period of any product which has been either repaired or replaced by Texmate.

USER'S RESPONSIBILITY

We are pleased to offer suggestions on the use of our various products either by way of printed matter or through direct contact with our sales/application engineering staff. However, since we have no control over the use of our products once they are shipped, **NO WARRANTY WHETHER OF MERCHANTABILITY, FITNESS FOR PURPOSE, OR OTHERWISE** is made beyond the repair, replacement, or refund of purchase price at the sole discretion of Texmate. Users shall determine the suitability of the product for the intended application before using, and the users assume all risk and liability whatsoever in connection therewith, regardless of any of our suggestions or statements as to application or construction. In no event shall Texmate's liability, in law or otherwise, be in excess of the purchase price of the product.

Texmate cannot assume responsibility for any circuitry described. No circuit patent or software licenses are implied. Texmate reserves the right to change circuitry, operating software, specifications, and prices without notice at any time.



1934 Kellogg Ave. Carlsbad CA 92008 USA
 Tel: 1-760-598-9899 • USA 1-800-839-6283 • That's 1-800-TEXMATE
 • Email: sales@texmate.com • Web: www.texmate.com

Texmate also has a branch in Taiwan.

DL-40JANUS Technical Manual Copyright © 2021 Texmate Inc. All rights reserved. Published by: Texmate Inc. USA. Information in this Technical Manual is subject to change without notice due to correction or enhancement. The information described in this manual is proprietary to Texmate, Inc. and may not be copied, reproduced or transmitted, in whole or in part, in connection with the design, manufacture, or sale of apparatus, device or private label product without the express written consent of Texmate, Inc.