



LYNX FAMILY

# BX-45 Lynx Panel Meter 4 1/2 DIGIT 0.56" LED in a 1/16 DIN Case

A versatile panel meter that utilizes many different types of plug-in signal conditioners.

## General Features

- External transmitters or signal conditioners can be eliminated by directly connecting the sensor to more than 33 **I-Series** Plug-in Input Signal Conditioners that include:
 

- AC Current	- Process
- AC Voltage	- Prototype
- DC Current	- Resistance
- DC Voltage	- Strain-gage
- Load Cell	- Temperature
- Pressure	- 4 to 20 mA
- Precalibrated **I-Series** input modules, that have span or zero potentiometers, can be interchanged between any **I-Series** compatible meter, without recalibration, because all of the analog scaling and reference circuitry is self-contained within the module.
- 24 V DC excitation is available to power external transmitters and 5 or 10 V DC excitation is available for strain-gages, load cells and resistance bridge type sensors.
- Auto-sensing AC/DC power supply. For voltages between **85-265 V AC / 95-300 V DC (PS1)** or 15-36 V AC / 10-72 V DC (PS2).
- Standard red or optional green or super bright red 4 1/2-digit 0.56" LED with display range -19999 to 19999 (40000 counts).
- Display brightness may be externally controlled.
- 1/16 DIN (96 x 24mm ) case easily mounts in thin or thick panels (up to 2").
- UL Listed.

## Input Module Compatibility

**LYNX FAMILY:** More than 33 different Plug-in **I-Series** Input Signal Conditioners are approved for Texmate's Lynx Family of meters. As shown on pages 3 to 5.



LYNX

See [www.texmate.com](http://www.texmate.com) for an up to date listing.

## Specifications

**Input Specs:** .....Depends on input signal conditioner  
**A/D Converter:** .....16 bit dual slope  
**Accuracy:** .....±(0.05% of reading + 3 counts)  
**Temp. Coeff:** .....100 ppm/°C (Typical)  
**Warm up time:** .....2 minutes  
**Conversion Rate:** .....3 conversions per second (Typical)  
**Display:** .....**4 1/2 digit 0.56" Red LED display (std)**,  
 0.56" Green or Super Bright Red (optn).  
 Range -19999 to 19999 counts.  
**Polarity:** .....Assumed positive. Displays - negative  
**Decimal Selection:** .....Header under face plate, X•X•X•X•X  
**Positive Overrange:** .....All digits flash.  
**Negative Overrange:** - negative sign and all digits flash  
**Power Supply:** .....AC/DC Auto sensing wide range supply  
**PS1 (std)** .....**85-265 VAC, 50-400Hz / 95-300 VDC @ 1.5W**  
**PS2** .....15-48 VAC, 50-400Hz / 10-72 VDC @ 1.5W  
**Operating Temp:** .....0 to 50 °C  
**Storage Temp:** .....-20 °C to 70 °C.  
**Relative Humidity:** .....95% (non condensing)  
**Case Dimensions:** .....1/16 DIN, Bezel: 96x24mm(3.78"x0.95")  
 Depth behind bezel 122.2 mm (4.83")  
 Plus 12.7mm (0.5") for Right-angled connector.  
**Weight:** .....7 oz., 9 oz when packed

## Index

Case Dimensions . . . . .	7	Input Module Calibration Procedures . . . . .	6-7
Component Layout . . . . .	3	Input Module Compatibility . . . . .	1
Connector Pinouts . . . . .	2	Input Module Component Glossary . . . . .	6
Connectors . . . . .	2	Installation Guidelines . . . . .	8
Functional Diagram . . . . .	2	Ordering Information . . . . .	8
General Features . . . . .	1	Pin Descriptions . . . . .	2
I-Series Input Signal Conditioning Modules . . . . .	3-5	Specifications . . . . .	1

## Functional Diagram

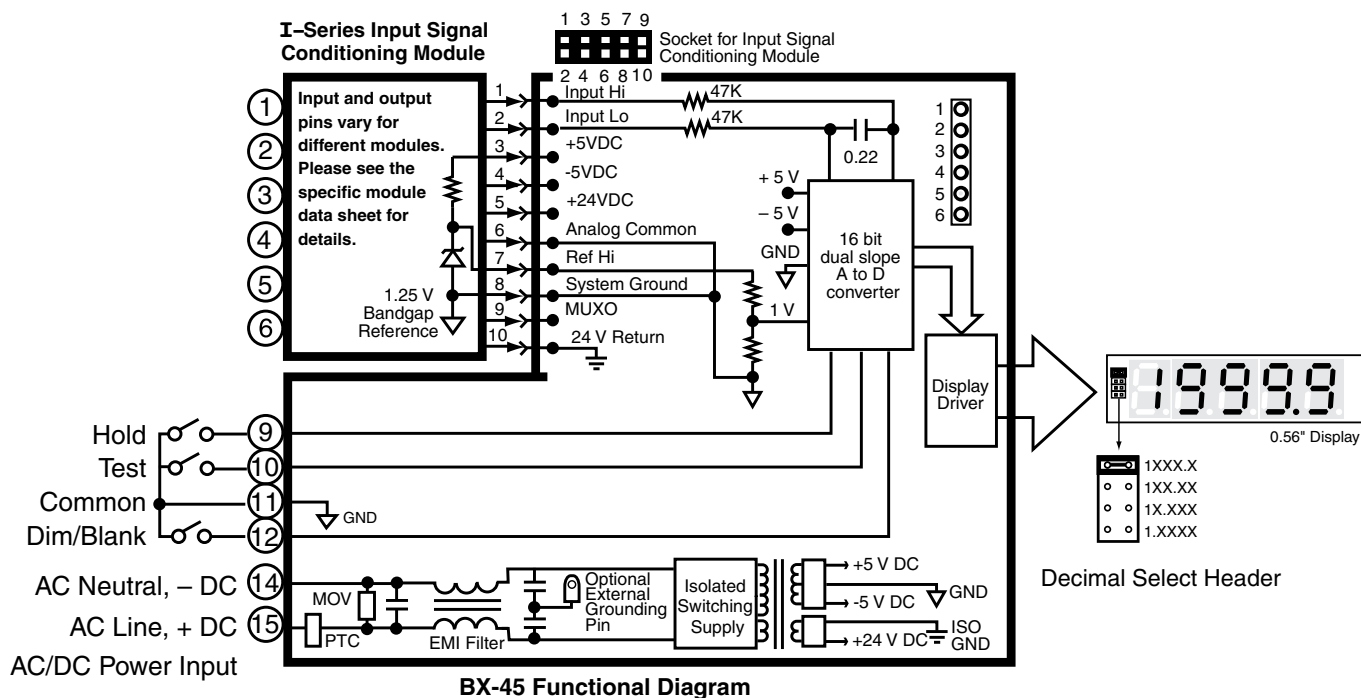

## Connector Pinouts

This meter comes standard with screw terminal plug connections.

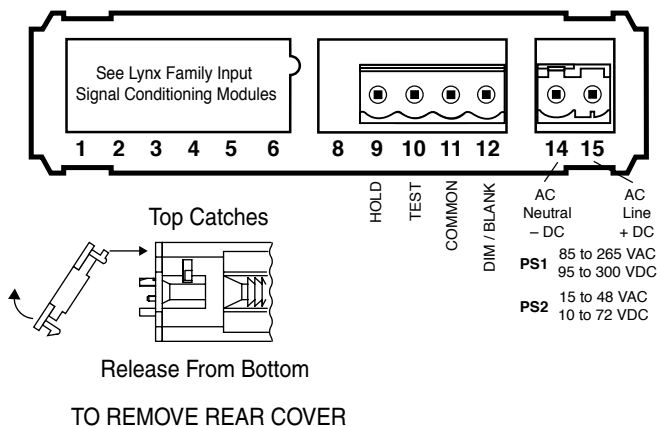

## Connectors

This meter uses plug-in type screw terminal connectors for all input and output connections. The power supply connections (pins 14 and 15) have a unique plug and socket outline to prevent cross connection. The main board uses standard right-angled connectors.

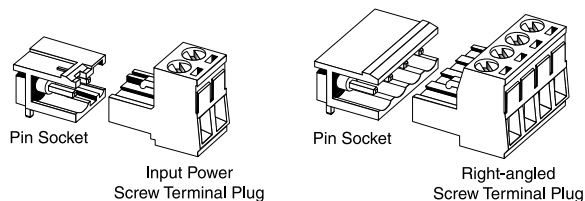

**WARNING:** AC and DC input signals and power supply voltages can be hazardous. Do Not connect live wires to screw terminal plugs, and do not insert, remove or handle screw terminal plugs with live wires connected.



## Pin Descriptions

**Pins 1 to 6** - Input Module: See the individual pin out of the input signal conditioning module selected. Usually Pin 1 is the Signal Input High pin and Pin 3 is the Signal Input Low pin. All calibration and scaling functions are performed on the individual input signal conditioner module. See pages 6 and 7.

**Pin 9** - Hold: If this pin is left unconnected the meter will operate in a free running mode. When this pin is connected to the Common Pin 11, the meter display will be latched. A/D conversions will continue, but the display will not be updated until Pin 9 is disconnected from Pin 11.

**Pin 10** - Display Test: When this pin is connected to the Common Pin 11, all segments of the display light up and 1888 is displayed. This is used to detect any missing segments in the display.

**Pin 11** - Common: To Hold, Test or Dim the display, the respective pins have to be connected to this Common Pin.

**Pin 12** - Dim/Blank: When this pin is connected to the Common Pin 11 the display is blanked out. If it is connected through an external 1KΩ pot, the display may be dimmed.

**Pin 14 & 15** - AC/DC Power Input: These pins are the power pins of the meter and they only accept a special polarized screw terminal plug that can not be inserted into any other input socket. The standard meter has a auto sensing AC/DC power supply that operates from 85-265 VAC/95-300 VDC (PS1 Std). An optional isolated low voltage power supply that operates from 15-48 VAC/10-72 VDC (PS2) is also available.

# Component Layout

## BX-45-XX-PS1 (High Voltage)

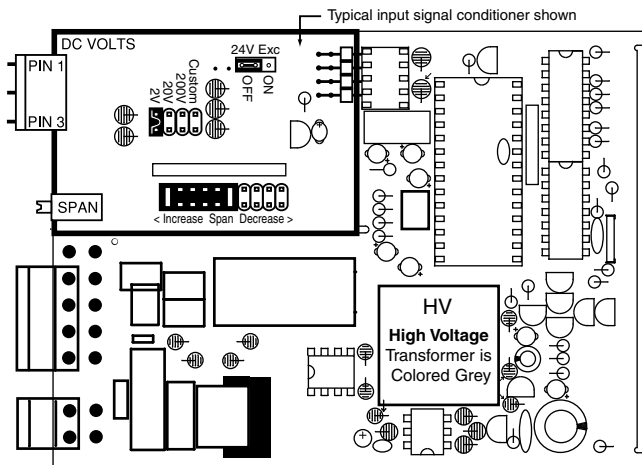

## BX-45-XX-PS2 (Low Voltage)

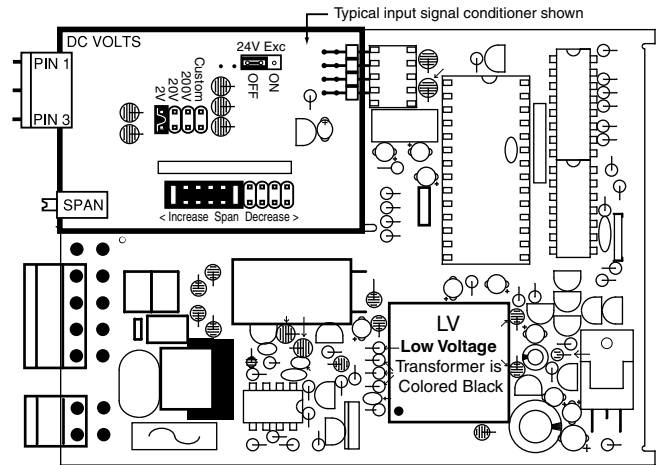

# I-Series Input Signal Conditioning Modules

Many additional input modules are available and others are constantly being developed. Check with your local distributor or [www.texmate.com](http://www.texmate.com) for updated information.

Precalibrated **I-Series** input modules, that have span or zero potentiometers, can be interchanged between any **I-Series** compatible meter, without recalibration, because all of the analog scaling and reference circuitry is self-contained within the module. Where appropriate, all the standard ranges shown are designed to be header selectable by the user, and Texmate's unique SPAN ADJUST Header facilitates scaling to almost any required engineering unit. See Input Module Component Glossary and Calibration on pages 6 and 8.

Unless otherwise specified Texmate will ship all modules precalibrated with factory preselected ranges and/or scalings as shown in **BOLD** type. Other precalibrated standard ranges or custom ranges may be ordered. Factory installed custom scaling and other custom options are also available (see Ordering Information, Special Options on last page).

### Symbols Indicate Module Compatibility Within Meter Families

TIGER Family	TIGER Family	TIGER Family
LEOPARD Family	LEOPARD Family	LEOPARD Family
LYNX Family	LYNX Family	LYNX Family
<b>ALL MODELS</b>	<b>SOME MODELS</b>	<b>MODEL SPECIFIC</b>

### IA03: AC Milliamps Scaled RMS, 2/20/200mA AC

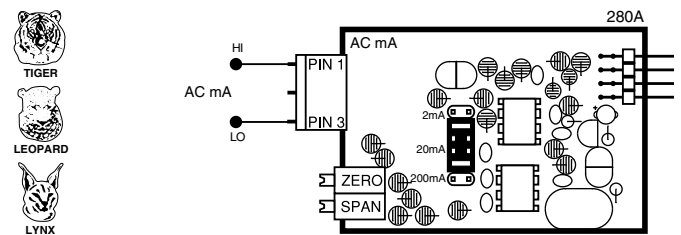

### IA01: AC Volts Scaled RMS, 200/300V AC

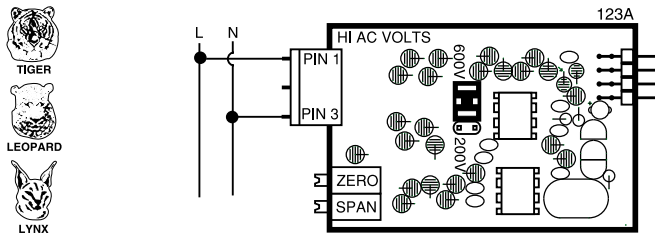

### IA04: AC Amps Scaled RMS, 1 Amp AC

### IA05: AC Amps Scaled RMS, 5 Amp AC

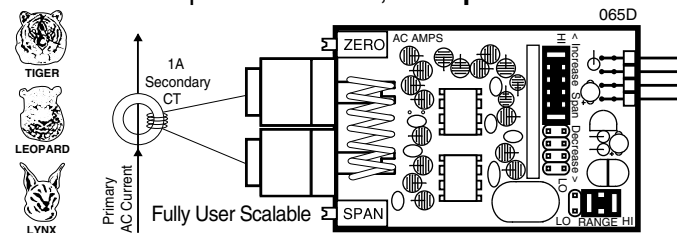

### IA02: AC Volts Scaled RMS, 200mV/2V/20V AC

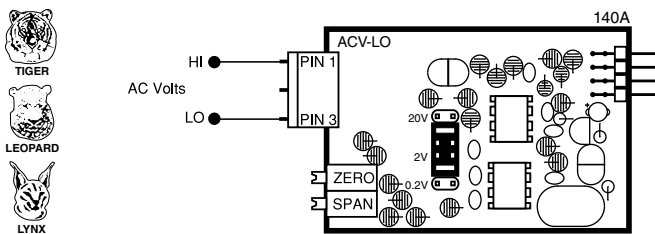

### IA06: AC Volts True RMS, 300V AC

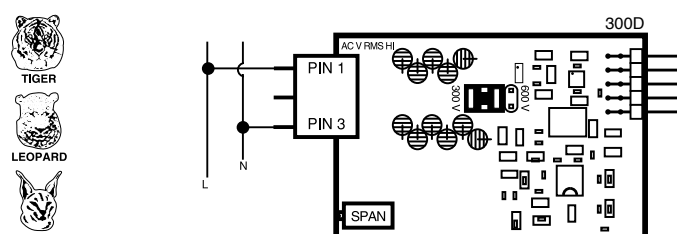

**IA07:** AC Volts True RMS, 200mV/2V/20V AC

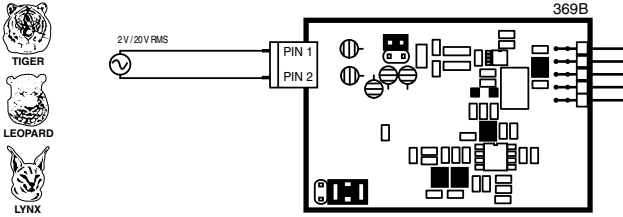

**IA08:** AC Milliamps True RMS, 2/20/200mA AC

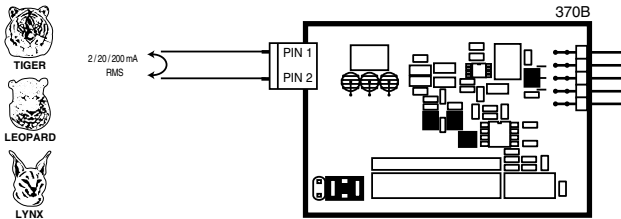

**IA09:** AC Amps True RMS, 1 Amp AC

**IA11:** AC Amps True RMS, 5 Amp AC

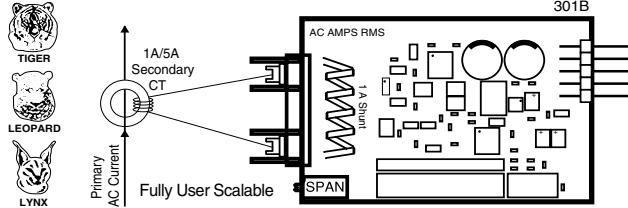

**IA10:** AC Millivolts, Scaled RMS, 100mV AC

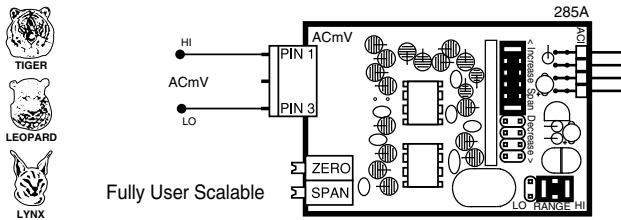

**IA12:** AC Millivolt RMS Sigma Delta

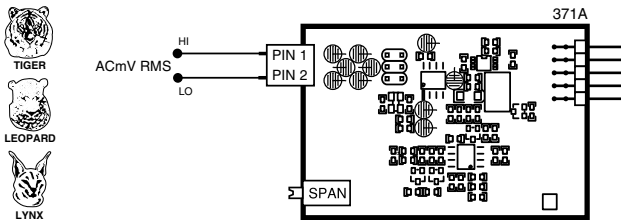

**ID01:** DC Volts, 2/20/200V/Custom w/24V DC Exc

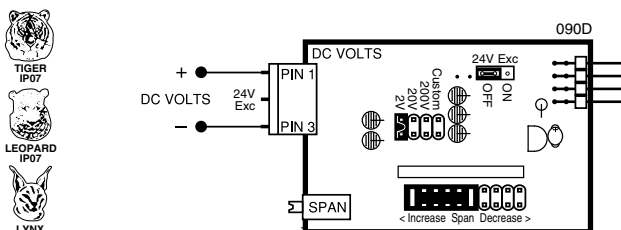

**ID02:** DC Millivolts, 20/50/100/200mV DC w/24V DC Exc

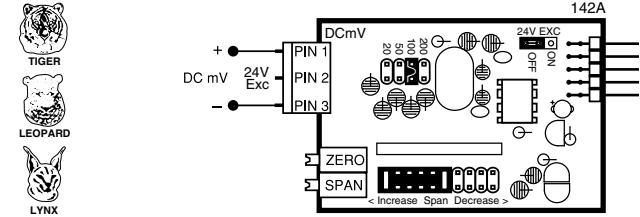

**ID03:** DC Milliamps, 2/20/200mA DC w/24V DC Exc

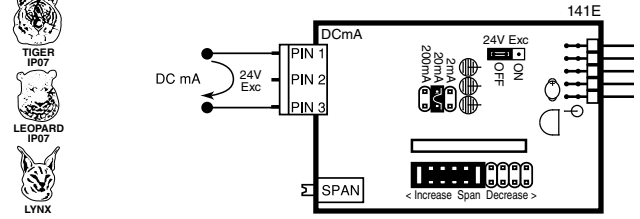

**ID04:** DC Amps, 5A DC

**ID09:** DC Amps, 1A DC

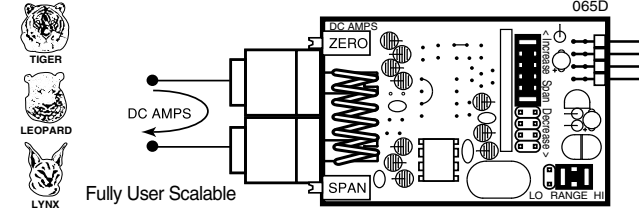

**ID05:** DC Volts 2/20/200/Custom V DC with Offset and 24V Exc.

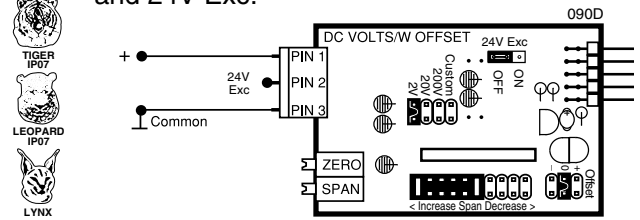

**ID07:** DC Milliamps, 2/20/200mA DC with Offset and 24V Exc

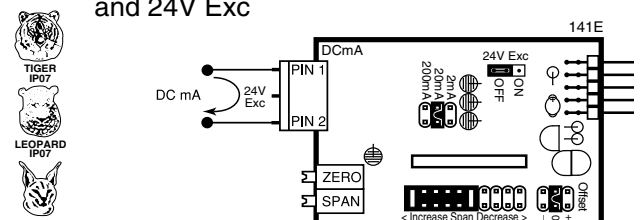

**IF02:** Line Frequency

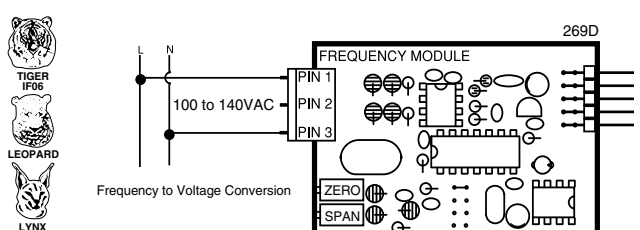

**IGYZ:** Universal Direct Pressure (Absolute or Differential/Gage)  
See below for ordering code options

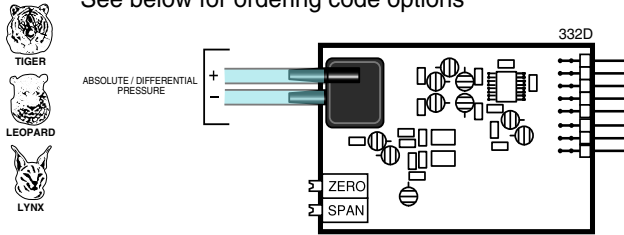

Direct Pressure (IGYX, IGYG & IGYZ) Ordering Code Options

Sensor Range	CH1 Order Code	CH2 Order Code
1 psi Absolute	A	A
1 psi Differential	B	B
5 psi Absolute	C	C
5 psi Differential	D	D
15 psi Absolute	E	E
15 psi Differential	F	F
30 psi Absolute	G	G
30 psi Differential	H	H
100 psi Absolute	J	J
100 psi Differential	K	K

For Single Channel IGYX with two digital inputs, the last digit of order code is always X.  
For Universal Direct Pressure IGYZ, the last digit of order code is always Z.

**IP01:** Process Loop, 4-20mA  
**IP02:** Process Loop, 4-20mA with 24VDC EXC

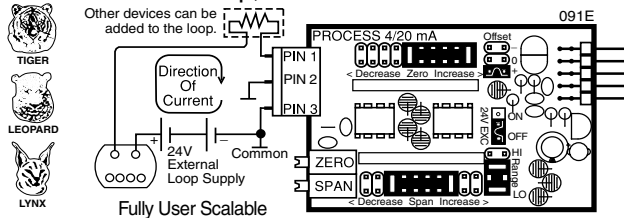

**IP03:** Process Input, 1-5V DC with Offset, 24V Exc

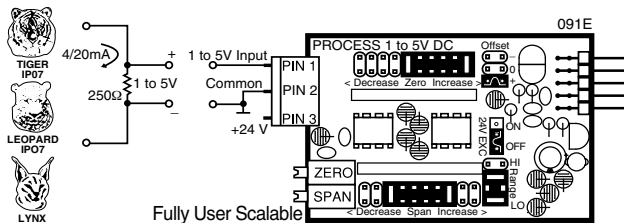

**IR02:** 3 wire Potentiometer 1KΩ min (0-F.S.)

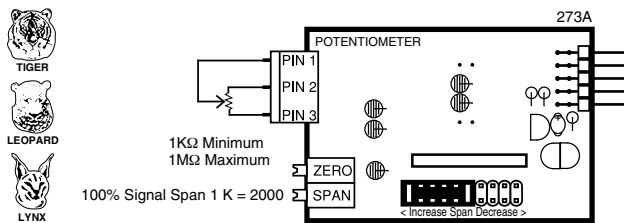

**IR03:** Linear Potentiometer 1KΩ min

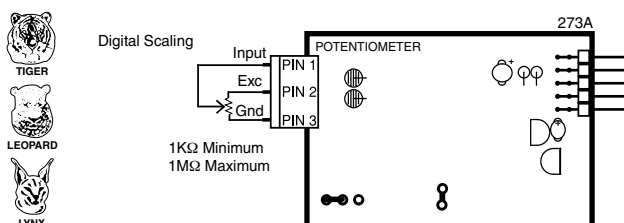

**IR04:** Resistance 2KΩ (Lynx only)  
**IR05:** Resistance 2KΩ (Leopard only)

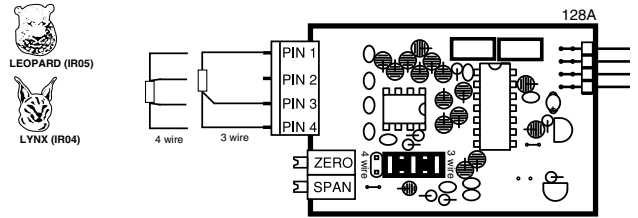

**IS05:** Pressure/Load Cell 20/2mV/V, 5/10V Exc 4-wire

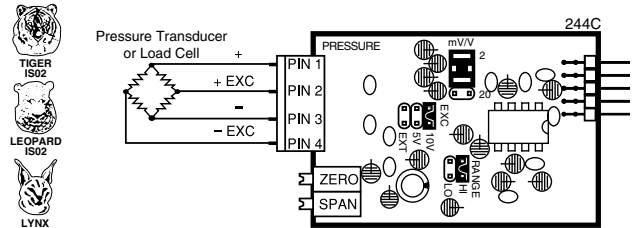

**IS06:** Pressure/Load Cell Ext Exc., 20/2mV/V, 4-wire

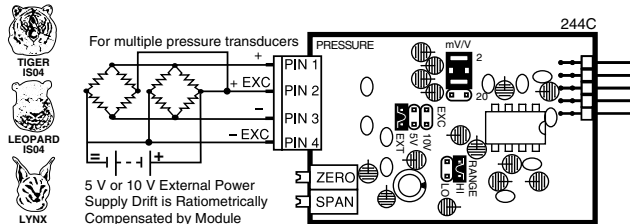

**IT03:** RTD, 100Ω Pt. 2/3/4-wire (-200 to 800°C)  
**IT04:** RTD, 100Ω Pt. 2/3/4-wire (-200 to 1470°F)  
**IT05:** RTD, 100Ω Pt. 2/3/4-wire (-199.9 to 199.9°F)  
**IT14:** RTD, 100Ω Pt. 2/3/4-wire (-199.9 to 199.9°C)

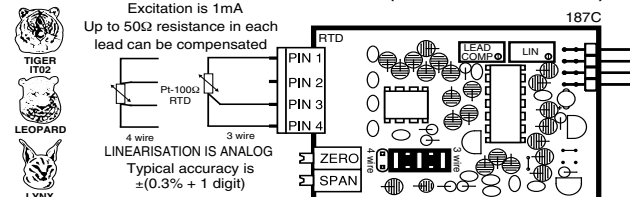

**IT06:** Thermocouple, J Type (0-1400 F)

**IT08:** Thermocouple, J Type (0-760 C)

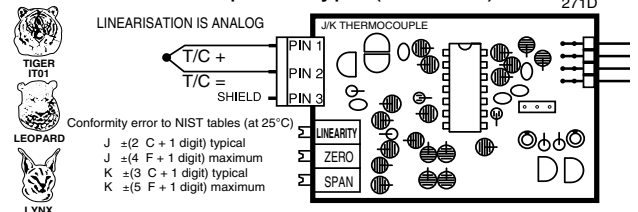

**IT07:** Thermocouple, K Type (0-1999 °F)

**IT09:** Thermocouple, K Type (0-1260 °C)

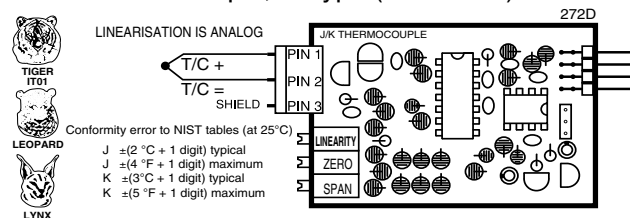

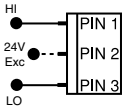

## Input and Output Pins

On most modules Pin 1 is the Signal High input and Pin 3 is the Signal Low input. Typically Pin 2 is used for Excitation Voltage output.

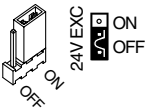

## 24V DC Output Header

On some modules this header enables a 24V DC 25mA (max) Excitation/Auxiliary output to be connected to Pin 2.



## INPUT RANGE Header

Range values are marked on the PCB. Typically two to four positions are provided, which are selected with either a single or multiple jumper clip. When provided, a custom range position is only functional when the option has been factory installed.

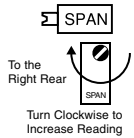

## SPAN Potentiometer (Pot)

If provided, the 15 turn SPAN pot is always on the right side (as viewed from the rear of the meter). Typical adjustment is 20% of the input signal range.

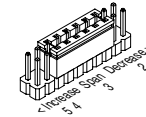

## SPAN ADJUST Header

This unique five-position header expands the adjustment range of the SPAN pot into five equal 20% steps, across 100% of the input Signal Span. Any input Signal Span can then be precisely scaled down to provide any required Digital Display span from 19999 counts to 0001 (one count).

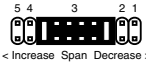

SPAN Adjust Header position	1	2	3	4	5
SPAN Pot %	20%	20%	20%	20%	20%
Signal Span %	20%	40%	60%	80%	100%

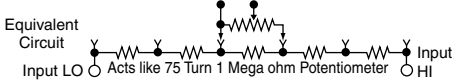

## SPAN RANGE Header

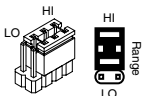

When this header is provided it works in conjunction with the SPAN ADJUST Header by splitting its adjustment range into a Hi and a Lo range. This has the effect of dividing the adjustment range of the SPAN pot into ten equal 10% steps across 100% of the input Signal Span.

SPAN Adjust Header position	Span Adjust Header					Span Range Header				
	1	2	3	4	5	1	2	3	4	5
SPAN Pot %	10%	10%	10%	10%	10%	10%	10%	10%	10%	10%
Signal Span %	10%	20%	30%	40%	50%	60%	70%	80%	90%	100%

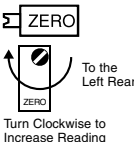

## ZERO Potentiometer (Pot)

If provided, the ZERO pot is always to the left of the SPAN pot (as viewed from the rear of the meter). Typically it enables the input signal to be offset  $\pm 5\%$  of full scale (-1000 to +1000 counts).

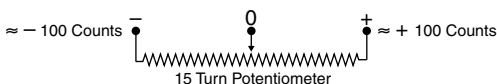

## ZERO OFFSET RANGE Header

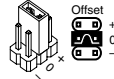

When provided, this three position header increases the ZERO pot's capability to offset the input signal, to  $\pm 25\%$  of the digital display span. For example a Negative offset enables a 1 to 5V input to display 0 to full scale. The user can select negative offset, positive offset, or no offset (ZERO pot disabled for two step non-interactive span and offset calibration).

NEGATIVE OFFSET Decreases Digital Reading		POSITIVE OFFSET Increases Digital Reading	
ZERO Pot%	- 100% of Offset	No Offset Zero Pot Disabled	+ 100% of Offset
Offset Range	$\approx - 5000$ Counts		$\approx + 5000$ Counts

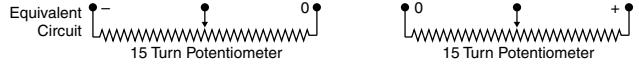

## ZERO ADJUST Header

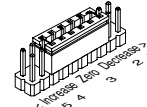

When this header is provided, it works in conjunction with the ZERO OFFSET RANGE Header, and expands the ZERO pot's offset capability into five equal negative steps or five equal positive steps. This enables virtually any degree of input signal offset required to display any desired engineering unit of measure.

ZERO Adjust Header position	Zero Adjust Header NEGATIVE OFFSET					Zero Offset Range Header - 0 + No Offset Zero Pot Disabled	Zero Adjust Header POSITIVE OFFSET				
	5	4	3	2	1		1	2	3	4	5
ZERO Pot %	-20%	-20%	-20%	-20%	-20%		+20%	+20%	+20%	+20%	+20%
Offset Range	$\approx -75\%$ of display span						$\approx +50\%$ of display span				

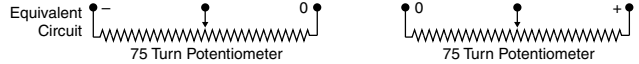

## Input Module Calibration



**WARNING:** AC and DC input signals and power supply voltages can be hazardous. Do Not insert, remove or handle modules with live wires connected to any terminal plugs.

Basic standard range calibration of direct reading modules that utilize either Auto Zero or a ZERO pot, an INPUT RANGE Header and or a SPAN pot.

- 1 If the module has an INPUT RANGE Header, reposition the jumper clip to select the desired input signal range.
- 2 Apply a zero input or short the input pins. The display will auto zero, or if the module has a ZERO pot, it should be adjusted until the display reads zero.
- 3 Apply a known input signal that is at least 20% of the full scale input range and adjust the SPAN pot until the display reads the exact input value.
- 4 Decimal Points. The selection or positioning of decimal points has no effect on the calibration of the modules

Wide range scaling, in engineering units not requiring offsets, with modules that utilize auto-zero or a ZERO pot, a SPAN RANGE Header and or a SPAN ADJUST Header.

Texmate's unique SPAN ADJUST and SPAN RANGE Headers provide the circuit equivalent of an ultra-precision one megohm 75 or 150 turn potentiometer that can infinitely scale down any Input Signal SPAN to provide any full scale Digital Display Span from 19999 (counts) to 0001 (one count).

## Input Module Calibration Procedures Continued

If the module has an INPUT RANGE Header, and the required full scale Digital Display Span (counts) is to be larger than the directly measured value of the input Signal Span, then the next lower range on the INPUT RANGE Header should be selected. The resulting over range Signal Span is then scaled down, by selecting the position of the SPAN RANGE Header and or the SPAN ADJUST Header, which will reduce the input Signal Span to a percentage, that the required Digital Display Span can be reached by calibration with the SPAN pot.

**Example A:** 0 to 10 V to read 0 to 18000 gallons.

Signal Span = 10V, Digital Display Span = 18000 counts

- 1 Select the 2 V INPUT RANGE Header position. This will provide a digital display of 18000 counts with an input of only 1.8 V which is  $(1.8 \div 10) = 18\%$  of the examples 10 V Signal Span.
- 2 To scale down the Signal Span to 18% select the 20% Signal Span position on the SPAN ADJUST Header (position 1) or if the module has a SPAN RANGE Header, select (LO Range) and 20% Signal Span position on the SPAN ADJUST Header (position 2).
- 3 Apply a zero input or short the input pins. The display will auto zero, or if the module has a ZERO pot, it should be adjusted until the display reads zero.
- 4 Apply 10 V and adjust the SPAN pot until the display reads 18000.

### Large offset scaling and calibration of process signal inputs with modules that utilize ZERO ADJUST Headers and or ZERO OFFSET RANGE Headers.

Texmate's unique ZERO OFFSET RANGE Header enables the use of a simple two step scaling and calibration procedure for those process signals that require large offsets. This eliminates the back and forth interaction, between zero and span settings, that is often required to calibrate less finely engineered products.

The first step is to set the ZERO OFFSET RANGE Header to the center position (No Offset) and scale down the Input Signal Span to a percentage that will enable calibration with the SPAN pot to reach the required Digital Display Span.

The second step is to set the ZERO ADJUST and or ZERO OFFSET RANGE Header to provide a positive or negative offset of sufficient counts that calibration with the ZERO pot will offset the Digital Display Span to produce the required digital reading.

**Example B:** 1 to 5 V to read -100.0 to 1500.0 °C.

Signal Span = 4V, Digital Display Span = 16000 counts

- 1 If the module has an INPUT RANGE Header the 2 V position should be selected. This will provide a digital display of 16000 counts for an input of 1.6 V which is  $(1.6 \div 4) = 40\%$  of the examples 4 V signal span. To scale down the Signal Span to 40% select the 40% Signal Span position on the SPAN ADJUST Header (position 2).
- 2 If the module is a Process Input 1-5 V DC type, select the (Hi Range) position on the SPAN RANGE Header and the 100% Signal Span position on the SPAN ADJUST Header (position 5, max increase). This will provide a digital display of 16000 counts for an input of 4V which is 100% of the examples 4V Signal Span.
- 3 Set the ZERO OFFSET RANGE Header to the center position (no offset). Apply 1 V and adjust the SPAN pot until the display reads 400 . A 4V input would then read 16000 counts.
- 4 Set the ZERO OFFSET RANGE Header to the negative offset position. If the module has a ZERO ADJUST Header select the position that will provide a negative offset of  $\approx -500$  counts. Apply 1 V and adjust the ZERO pot until the display reads -100. Apply 5 V and check that the display reads 15000. Select decimal point 1XXX.X to display -100.0 to 1500.0.

**Example C:** 4 to 20 mA to read 00.00 to +100.00%

Signal Span = 16 mA, Digital Display Span = 10000 counts.

- 1 The full scale Signal Span of the Process Input 4-20 mA modules is 0 to 20 mA for a full scale Digital Display Span of 0 to 20000 counts. This will provide a digital display of 10000 counts with an input of only 10 mA which is  $(10 \div 16) = 62.5\%$  of the examples 16 mA signal span.
- 2 To scale down the Signal Span to 62.5% select the (Hi Range) Position on the Span Range Header and the 70% Signal Span position on the SPAN ADJUST Header (position 2).
- 3 Set the ZERO OFFSET RANGE Header to the center position (no offset). Apply 4 mA and adjust the SPAN pot until the display reads 2500 . A 16 mA input would then read 10000 counts.
- 4 Set the ZERO OFFSET RANGE Header to the positive offset position. If the module has a ZERO ADJUST Header select the position that will provide a negative offset of  $\approx -2500$  counts. Apply 4 mA and adjust the ZERO pot until the display reads 0000. Apply 20 mA and check that the display reads 10000. Select decimal point 1XX.XX to display 00.00 to 100.00

## Case Dimensions

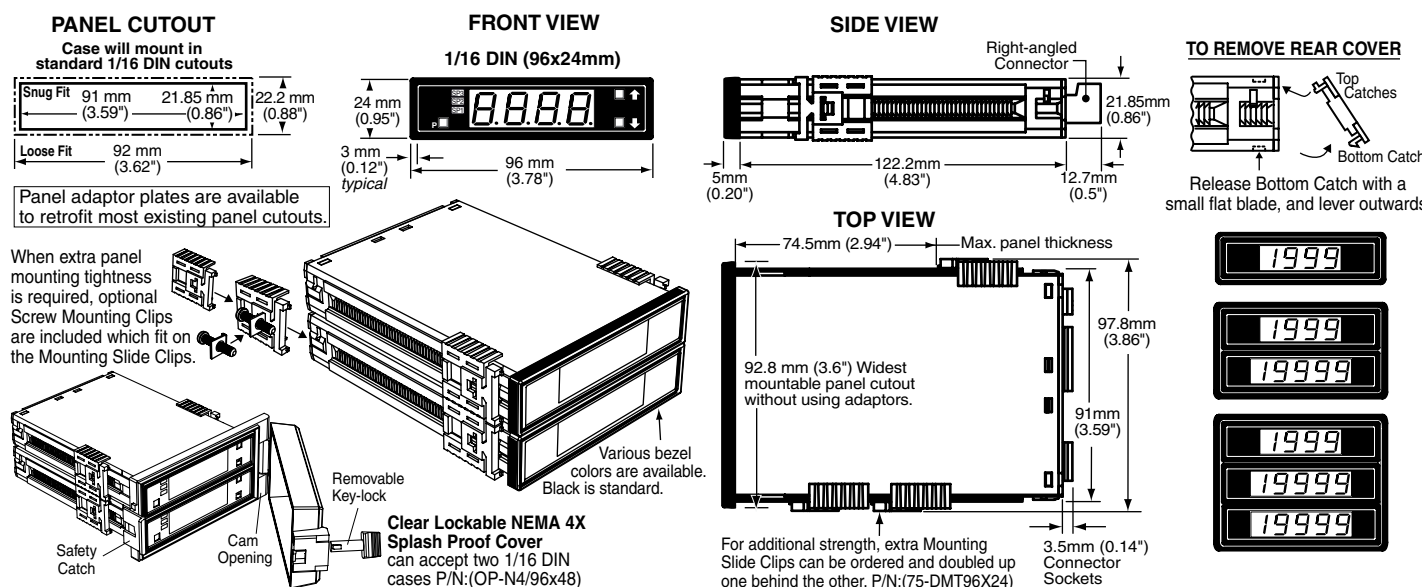

### Installation

1. Install and wire meter per local applicable codes/regulations, the particular application, and good installation practices.
2. Install meter in a location that does not exceed the maximum operating temperature and that provides good air circulation.
3. Separate input/output leads from power lines to protect the meter from external noise. Input/output leads should be routed as far away as possible from contactors, control relays, transformers and other noisy components. Shielding cables for input/output leads is recommended with shield connection to earth ground near the meter preferred.
4. A circuit breaker or disconnect switch is required to disconnect power to the meter. The breaker/switch should be in close proximity to the meter and marked as the disconnecting device for the meter or meter circuit. The circuit breaker or wall switch must be rated for the applied voltage (e.g., 120VAC or 240VAC) and current appropriate for the electrical application (e.g., 15A or 20A).
5. See *Case Dimensions* section for panel cutout information.
6. See *Connector Pinouts* section for wiring.
7. Use 28-12 AWG wiring, minimum 90°C (HH) temperature rating. Strip wire approximately 0.3 in. (7-8 mm).
8. Recommended torque on all terminal plug screws is 4.5 lb-in (0.51 N-m).

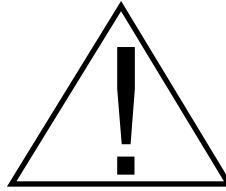



# Ordering Information

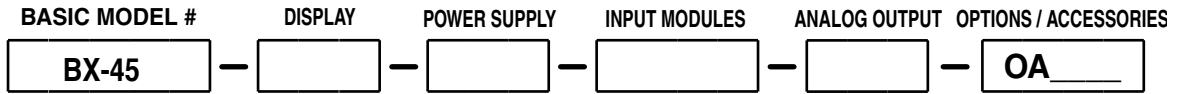

**Ordering Example: BX-45-DR-PS1-IA01-OA2, the 2 OA's are, CR-CHANGE and a 75-DMTC96X24**

**► BASIC MODEL NUMBER**

**BX-45** . . . . 96x24mm, Lynx, 4.5 Digit . . . . .

**Standard Options for this Model Number**

<i>Order Code Suffix</i>	<i>Description</i>	<i>List</i>
--------------------------	--------------------	-------------

**► DISPLAY**

**DR** . . . Red LED, 0.56 inch high . . . . .  
**DB** . . . Super-bright Red LED, 0.56 inch high . . . . .  
**DG** . . . Green LED, 0.56 inch high . . . . .

**► POWER SUPPLY**

**PS1** . . . 85-265VAC/95-300VDC . . . . .  
**PS2** . . . 15-48VAC/10-72VDC . . . . .

**► INPUT MODULES (Partial List. See www.texmate.com)**

Unless otherwise specified Texmate will ship all modules pre calibrated with factory preselected ranges and/or scalings as shown in **BOLD** type.

IA01 . . . AC-Volts Scaled RMS, 200/**300V AC** . . . . .  
 IA02 . . . AC-Volts Scaled RMS, 200mV/**2V/20V AC** . . . . .  
 IA03 . . . AC-mA Scaled RMS, **2/20/200mA AC** . . . . .  
 IA04 . . . AC-Amps Scaled RMS, **0-1 Amp AC (0-100.00)** . . . . .  
 IA05 . . . AC-Amps Scaled RMS, **0-5 Amp AC (0-100.00)** . . . . .  
 IA06 . . . AC-Volts True RMS, 200/**300V AC** . . . . .  
 IA07 . . . AC-Volts True RMS, 200mV/**2V/20V AC** . . . . .  
 IA08 . . . AC-mA True RMS, **2/20/200mA AC** . . . . .  
 IA09 . . . AC-Amps True RMS, **0-1 Amp AC (0-100.00)** . . . . .  
 IA10 . . . AC-Millivolt, Scaled RMS, **100mV AC** . . . . .  
 IA11 . . . AC-Amps True RMS, **0-5 Amp AC (0-100.00)** . . . . .  
 IA12 . . . AC-Millivolt, True RMS, **100mV AC** . . . . .  
 ID01 . . . DC-Volts, **2/20/200V**/Custom w/24V DC Exc . . . . .  
 ID02 . . . DC-Millivolt, 20/50/**100/200mV DC** w/24V DC Exc . . . . .  
 ID03 . . . DC-Milliamp, **2/20/200mA DC** w/24V DC Exc . . . . .  
 ID04 . . . DC-Amps, **5A DC** . . . . .  
 ID05 . . . DC-Volts **2/20/200/Custom V DC** w/Offset and 24V Exc. . . . .  
 ID07 . . . DC-Milliamp, **2/20/200mA DC** w/Offset and 24V Exc . . . . .  
 ID09 . . . DC-Amps, **1A DC** . . . . .  
 IF02 . . . Line Frequency, 50-500VAC, 199.9Hz, or optional 400Hz . . . . .  
 IGYZ\* . . Universal Direct Pressure . . . . .

\*View the IG- Ordering Code on page 5 to determine the value for Y & Z (IGAZ to IGKZ)

IP01 . . Process Loop, **4-20mA(0-100.00)** . . . . .  
 IP02 . . Process Loop, **4-20mA(0-100.00)** w/24VDC Exc. . . . .  
 IP03 . . Process Input, **1-5V DC(0-100.00)** w/Offset, 24V Exc . . . . .  
 IR02 . . 3-Wire Potentiometer 1KΩ min (0-F.S.) . . . . .  
 IR03 . . Linear Potentiometer, 3-wire, 1KΩ min . . . . .  
 IR04 . . Resistance 2KΩ . . . . .  
 IS04 . . Pressure Ext Exc., 20/2mV/V, **4/6-wire** . . . . .  
 IS05 . . Pressure/Load Cell 20/2mV/V, 5/10V Exc 4-wire . . . . .  
 IS06 . . Pressure/Load Cell Ext Exc., 20/2mV/V, 4-wire . . . . .  
 IT03 . . RTD, 100Ω Pt. **2/3/4-wire (-200 to 800°F)** . . . . .  
 IT04 . . RTD, 100Ω Pt. **2/3/4-wire (-200 to 1470°F)** . . . . .  
 IT05 . . RTD, 100Ω Pt. **2/3/4-wire (-190.0 to 199.0°F)** . . . . .  
 IT06 . . Thermocouple, J Type **(0-1400 °F)** . . . . .  
 IT07 . . Thermocouple, K Type **(0-1999°F)** . . . . .  
 IT08 . . Thermocouple, J Type **(0-760 °C)** . . . . .  
 IT09 . . Thermocouple, K Type **(0-1260°C)** . . . . .  
 IT14 . . RTD, 100Ω Pt. **2/3/4-wire (-199.0 to 199.0°C)** . . . . .

**Special Options and Accessories (OA's)**

<i>Part Number</i>	<i>Description</i>	<i>List</i>
--------------------	--------------------	-------------

**► SPECIAL OPTIONS (Specify Input & Req. Reading)**

**CR-CHANGE** . . Calibrated Range Change to another Standard Range. . . . .  
**CS-4.5/5/6** . . . Custom display scaling within std. ranges . . . . .  
**CSS-SETUP** . . . NRC to set-up custom special scaling beyond the std. range. . . . .  
**CSS-56/INSTL** . Installation, specify serial #CSS . . . . .

**► ACCESSORIES (Specify Serial # for Custom Artwork Installation)**

**75-DMTC96X24** Side Slide Brackets (2 pc) - extra set, extra strength . . . . .  
**75-DBBZ96X24** Extra Black Bezel for 96x24mm Case . . . . .  
**ART-FS-S/D/C** . . . NRC for artwork & set-up Faceplate/Desc/Co.Logo. . . . .  
**ART-FS-S/D** . . . NRC for artwork & set-up Faceplate/Desc. . . . .  
**ART-FS-001** . . . Install Custom Faceplate per meter - 1 color . . . . .  
**93-PLUG2P-DP** . Extra Screw Terminal Conn., 2 Pin Power Plug . . . . .  
**93-PLUG2P-DR** . Extra Screw Terminal Conn., 2 Pin Plug . . . . .  
**93-PLUG3P-DR** . Extra Screw Terminal Conn., 3 Pin Plug . . . . .  
**93-PLUG4P-DR** . Extra Screw Terminal Conn., 4 Pin Plug . . . . .  
**DN.CAS96X24L** Extra Complete 96x24mm Case with bezel . . . . .  
**OP-MTLCLIP** . . . Screw Mounting Clips (2 pc) to screw tighten slide brackets . . . . .  
**75-DTP96X24** . . Black Metal Trim Plate (96x24mm Case) 1 Meter . . . . .  
**75-DTP2X9624** . Black Metal Trim Plate (96x24mm Case) 2 Meters . . . . .  
**75-DTP3X9624** . Black Metal Trim Plate (96x24mm Case) 3 Meters . . . . .

*Many other options and accessories are available. See full price list for more details. Prices subject to change without notice.*

**WARRANTY**

Texmate warrants that its products are free from defects in material and workmanship under normal use and service for a period of one year from date of shipment. Texmate's obligations under this warranty are limited to replacement or repair, at its option, at its factory, of any of the products which shall, within the applicable period after shipment, be returned to Texmate's facility, transportation charges pre-paid, and which are, after examination, disclosed to the satisfaction of Texmate to be thus defective. The warranty shall not apply to any equipment which shall have been repaired or altered, except by Texmate, or which shall have been subjected to misuse, negligence, or accident. In no case shall Texmate's liability exceed the original purchase price. The aforementioned provisions do not extend the original warranty period of any product which has been either repaired or replaced by Texmate.

**USER'S RESPONSIBILITY**

We are pleased to offer suggestions on the use of our various products either by way of printed matter or through direct contact with our sales/application engineering staff. However, since we have no control over the use of our products once they are shipped, **NO WARRANTY WHETHER OF MERCHANTABILITY, FITNESS FOR PURPOSE, OR OTHERWISE** is made beyond the repair, replacement, or refund of purchase price at the sole discretion of Texmate. Users shall determine the suitability of the product for the intended application before using, and the users assume all risk and liability whatsoever in connection therewith, regardless of any of our suggestions or statements as to application or construction. In no event shall Texmate's liability, in law or otherwise, be in excess of the purchase price of the product.

Texmate cannot assume responsibility for any circuitry described. No circuit patent or software licenses are implied. Texmate reserves the right to change circuitry, operating software, specifications, and prices without notice at any time.



450 State Place • Escondido, CA 92029

Tel: 1-760-598-9899 • USA 1-800-839-6283 • That's 1-800-TEXMATE  
 Fax: 1-760-598-9828 • Email: orders@texmate.com • Web: www.texmate.com

Texmate has authorized distributors throughout the USA and in 28 other countries.

**For product details visit [www.texmate.com](http://www.texmate.com)**

Local Distributor Address