



Optional ▲
Green LED display

Optional ▲
Custom Faceplate

**3 1/2 Digit with 0.56" LEDs
in a 1/16 DIN Case**

BX-35-PROCESS

4-20mA / 0-10V process

Easily user scaled, this meter is ideal for 4-20mA process loop / 0-10V measurement and indication in any engineering unit of measure.

Compatibility

The BX-Series have a matching DIN case style that is complementary to the Leopard and Tiger family of meters. BX-Meters are the OEM's choice for switchboard and process indication. Each model is dedicated to a specific application and designed for quick and easy installation.



Typical Application Connections

4 to 20mA Process Loop Measurement

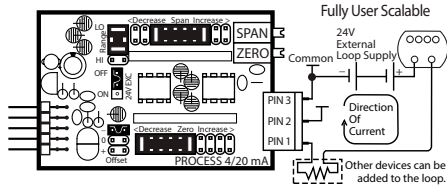

Order IP02, if you require the loop excitation voltage (24VDC@100mA) to be supplied by the meter.

ID01: DC Volts, 2/20/200V/Custom w/24V DC Exc

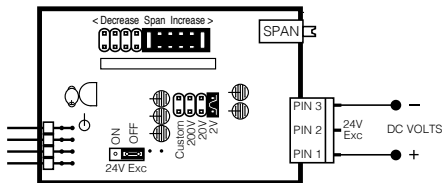

ID05: DC Volts 2/20/200/Custom V DC with Offset and 24V Exc.

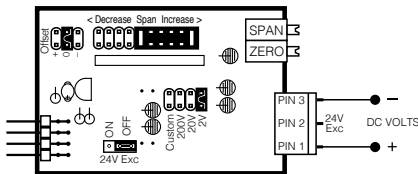

General Features

The BX-35-PROCESS is cost-effective 4-20mA process loop / 0-10V measuring meter. It is easily user adjustable to any reading between -1999 and +1999 without component changes. The unique set of Signal Conditioning Components incorporated in this meter, enables the use of a simple two step scaling and calibration procedure, which eliminates the back and forth interaction between zero and span settings, which is often required to calibrate less finely engineered products.

Specifications

Input Configuration:..... Series connection to 4-20mA process loop or Single ended 0-10V DC.

Full Scale Ranges:..... User adjustable to any scaling between -1999 to +1999

A/D Converter:..... 12 bit dual slope

Accuracy:..... ±(0.05% of reading + 3 counts)

Temp. Coeff.:..... 100 ppm/°C (Typical)

Warm up time:..... 2 minutes

Conversion Rate:..... 3 conversions per second (Typical)

Display:..... **3 1/2 digit 0.56" Red LED display (std)**, 0.56" GREEN or Super Bright RED are optional. Range -1999 to 1999 counts.

Decimal Selection:..... Header under face plate, X•X•X•X

Positive Overrange:..... 1 (MSD) is displayed with all other digits blank.

Power Supply:..... AC/DC Auto sensing wide range supply

PS1 (std)..... **85-265 VAC, 50-400Hz / 95-300 VDC @1.5W**

PS2..... 15-48 VAC, 50-400Hz / 10-72 VDC @4.0W

Operating Temp.:..... 0 to 50 °C

Storage Temp.:..... -20 °C to 70 °C.

Relative Humidity:..... 95% (non condensing)

Case Dimensions:..... 1/16 DIN Bezel: 96x24mm (3.78"x0.95")

Depth behind bezel 122.2 mm (4.83")

Plus 12.7mm (0.5") for Right-angled connector..

Weight:..... 7 oz., 9 oz when packed.

Certification:..... UL Listed.

BX-Series, the OEMs choice for switchboard and process indication

BX-35-ACA..... AC amps, Scales RMS (True RMS Opt.). (5 Amp Internal Shunt), 3.5digit

BX-35-ACV..... AC volts, Scaled RMS (True RMS Opt.). 199.9/300V AC Header

.....Selectable Ranges, 3.5 digit

BX-35-DCA..... DC mV ±50mV, ±100mV, ±200mV Header Selectable Ranges, 3.5 digit

BX-35-DCV..... DC volts ±2V/±20V/±200V Header Selectable Ranges, 3.5 digit

BX-35-PROCESS..... Process 4 to 20mA (100.0), easily user scalable, 3.5 digit w/Exc. opt

BX-35-HZ..... AC Line Frequency 15.0Hz to 199.9Hz. Up to 300V AC input, 3.5 digit

BX-35-TC-KF or JF K or J Thermocouple with °F, optional °C, 3.5 digit

BX-35-RTD-F..... 100Ω platinum RTD, 3 or 4 wire, °F in 1° resolution, optional °C, 3.5 digit

BX-35-PRESSURE..... Pressure, Load Cell 20mV/2mV/V, 5/10V Exc 4-wire 3.5 digit

BX-45-ACA..... AC amps, Scales RMS (True RMS Opt.). (5 Amp Internal Shunt), 4.5digit

BX-45-ACV..... AC volts, Scaled RMS (True RMS Opt.). 199.9/300.0V AC Header

.....Selectable Ranges, 4.5 digit

BX-45-DCA..... DC mV ±50mV, ±100mV, ±200mV Header Selectable Ranges, 4.5 digit

BX-45-DCV..... DC volts ±2V/±20V/±200V Header Selectable Ranges, 4.5 digit

BX-45-PROCESS..... Process 4 to 20mA (100.00), easily user scalable, 4.5 digit w/Exc. opt

BX-45-TC-KF..... K Thermocouple with °F, optional °C, 4.5 digit

BX-45-TC-JF..... J Thermocouple with °F, optional °C, 4.5 digit

BX-45-RTD-F..... 100Ω platinum RTD, 3 or 4 wire, °F in 1° resolution, optional °C, 4.5 digit

BX-45-PRESSURE..... Pressure, Load Cell 20mV/2mV/V, 5/10V Exc 4-wire 4.5 digit

Connector Pinouts

This meter uses plug-in type screw terminal connectors for all connections.

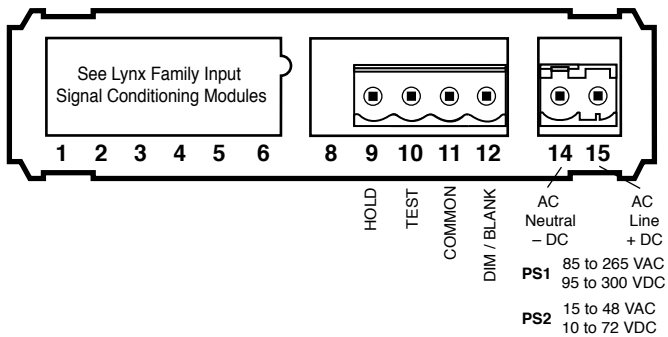

Pin Descriptions

Pins 1 to 3 - Input

Pin 9 - Hold: If this pin is left unconnected the meter will operate in a free running mode. When this pin is connected to the Common Pin 11, the meter display will be latched. A/D conversions will continue, but the display will not be updated until Pin 9 is disconnected from Pin 11.

Pin 10 - Display Test: When this pin is connected to the Common Pin 11, all segments of the display light up and 1888 is displayed. This is used to detect any missing segments in the display.

Pin 11 - Common: To Hold, Test or Dim the display, the respective pins have to be connected to this Common Pin.

Pin 12 - Dim/Blank: When this pin is connected to the Common Pin 11 the display is blanked out. If it is connected through an external 1KΩ pot, the display may be dimmed.

Pin 14 & 15 - AC/DC Power Input: These pins are the power pins of the meter and they only accept a special polarized screw terminal plug that can not be inserted into any other input socket. The standard meter has a auto sensing AC/DC power supply that operates from 85-265 VAC/95-300 VDC (PS1 Std). An optional isolated low voltage power supply that operates from 15-48 VAC/10-72 VDC (PS2) is also available.

Connectors

This meter uses plug-in type screw terminal connectors for all input and output connections. The power supply connections (pins 14 and 15) have a unique plug and socket outline to prevent cross connection. The main board uses standard right-angled connectors.

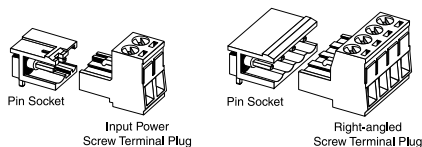

WARNING: AC and DC input signals and power supply voltages can be hazardous. Do Not connect live wires to screw terminal plugs, and do not insert, remove or handle screw terminal plugs with live wires connected.

Component Layout

MAIN BOARD

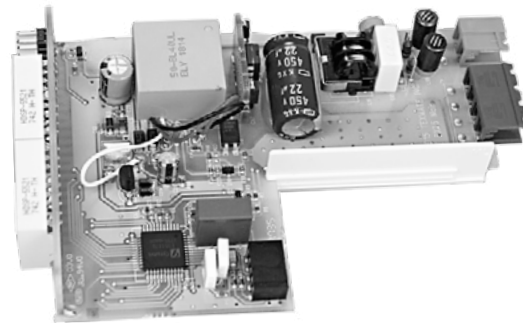

4-20mA INPUT MODULE

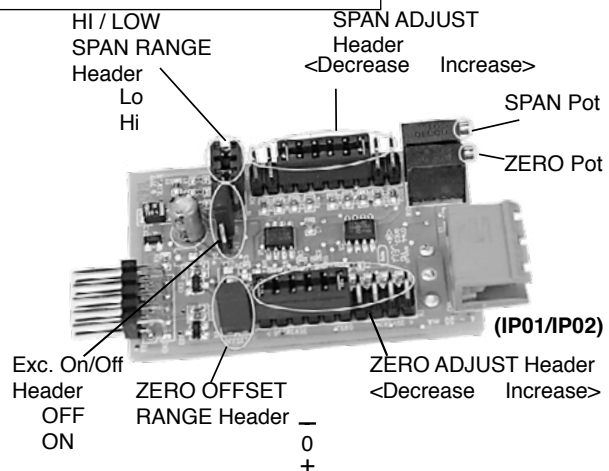

0-10V INPUT MODULE

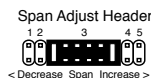
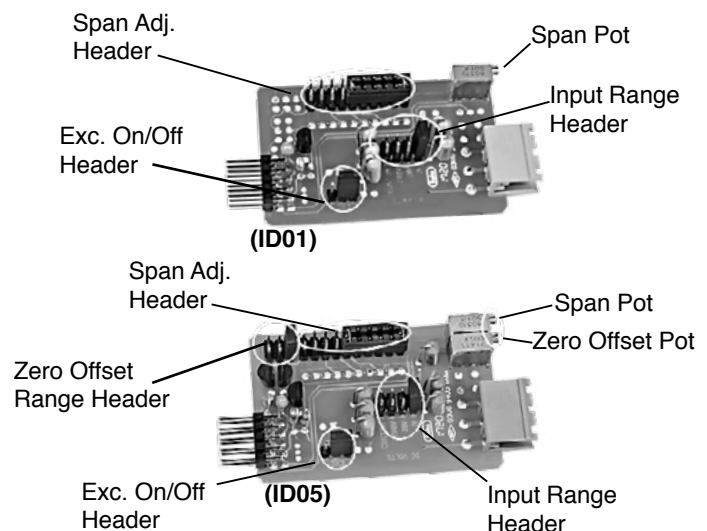

SPAN Adjust Header position	1	2	3	4	5
SPAN Pot %	10%	10%	10%	10%	10%
Signal Span %	20%	40%	60%	80%	100%

Calibration Procedure for 0-10V input

1. Select the required full scale voltage range, by repositioning the jumper clip on the range select header.
2. Apply an input of 0 millivolts. Adjust the zero offset pot until the meter reads 0000.
4. Apply a known high input signal that is within the full scale voltage range selected.
5. Adjust the Span Pot until the meter displays the required reading for the signal being applied.
6. The BX-35-PROCESS is now calibrated and ready for use.
(Whenever a new range is selected, re-calibration is required to meet the specified accuracy).

Calibration Procedure for 4-20mA input

The first step is to disengage the ZERO Pot and scale down the Signal Span input to produce the desired Digital Display Span output.

Signal Span is defined as the total change of signal input that would be required for a specific change of the Digital Display. The largest Signal Span that can be specified with a 4 to 20mA input is 16mA. A 4mA Signal Span proportionately scaled can meet full scale display accuracy.

Digital Display Span is defined as the exact total in counts, that the display would change within a specific Signal Span. The largest Digital Display Span that can be displayed is -1999 to +1999 (4000 counts). 16mA can not display +4000, so instead 4mA can be scaled to +1000.

The second step is to select a Zero Offset Range and offset the Digital Display Span with the ZERO Pot, until the desired reading is displayed.

Maximum offset is -3000 to +2000 counts. A Digital Display Span of 4000 counts requires an offset of -3000 to display -1999 to +1999.

For example: A 4 to 20mA input to read -40.0°C to +199.9°C
Signal Span = 16mA, Digital Display Span = 2400 counts.

1. Remove the meter from its case and set the Zero Offset Range Header to the Calibrate position. Select the 1400 – 3000 position on the Span Adjust Header and slide the meter back into the case.
2. Connect power to the meter and apply 4mA (25% of 16mA). Adjust the SPAN Pot until the display reads +600 (25% of 2400). The meter is now scaled for a Signal Span of 16mA and a Digital Display Span of 2400 counts. In the example 4mA should read -400 and 20mA read 1999, therefore the Digital Display Span should be offset by -1000.
3. Disconnect power and remove the meter from the case, select the Negative offset position on the ZERO OFFSET RANGE Header, and slide the meter back into the case.
4. Connect power to the meter, apply 4mA and adjust the ZERO Pot until the display reads -400. With the Digital Display Span now offset by -1000 counts, the meter will read -400 for a 4mA input, and read +1999 for a 20mA input. Select decimal point 1XX.X to display -40.0 to +199.9. Then apply the self adhesive °C symbol (from the Face Plate Descriptor sheet provided) to complete the calibration.

Signal Conditioning Compensets

INPUT RANGE Header

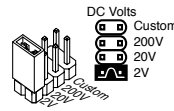

Range values are marked on the PCB. Three positions are provided. After selecting a new range with the single jumper clip, re-calibration is required.

SPAN Potentiometer (Pot)

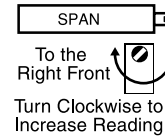

The 15 turn SPAN pot is always on the right side (as viewed from the front of the meter). Typical adjustment is 100% of the input signal range.

ZERO Potentiometer (Pot)

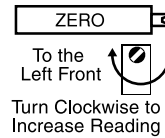

The ZERO pot is always to the left of the SPAN pot (as viewed from the front of the meter). Typically it enables the displayed reading to be offset ± 100 counts.

ZERO OFFSET RANGE Header

When provided, this three position header increases the ZERO pot's capability to offset the input signal, to $\pm 25\%$ of the digital display span. For example a Negative offset enables a 1 to 5V input to display 0 to full scale. The user can select negative offset, positive offset, or no offset (ZERO pot disabled for two step non-interactive span and offset calibration).

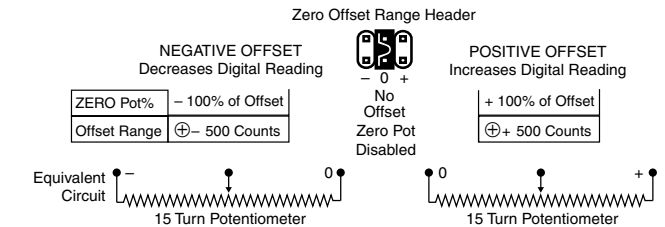

ZERO ADJUST Header

When this header is provided, it works in conjunction with the ZERO OFFSET RANGE Header, and expands the ZERO pot's offset capability into five equal negative steps or five equal positive steps. This enables virtually any degree of input signal offset required to display any desired engineering unit of measure.

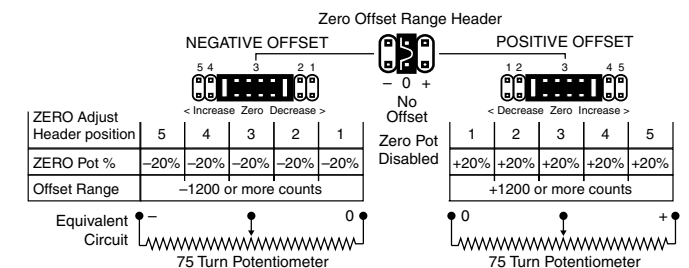

24V DC Output Header

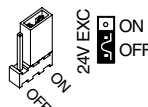

On some modules this header enables a 24V DC 125mA (max) Excitation/Auxiliary output to be connected to Pin 3.

SPAN ADJUST Header

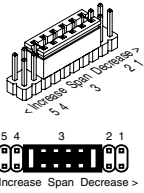

This unique five-position header expands the adjustment range of the SPAN pot into five equal 20% steps, across 100% of the input Signal Span. Any input Signal Span can then be precisely scaled down to provide any required Digital Display span from 1999 counts to 001 (one count).

SPAN Adjust Header position	1	2	3	4	5
SPAN Pot %	20%	20%	20%	20%	20%
Signal Span %	20%	40%	60%	80%	100%



SPAN RANGE Header

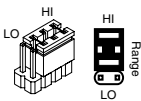

When this header is provided it works in conjunction with the SPAN ADJUST Header by splitting its adjustment range into a Hi and a Lo range. This has the effect of dividing the adjustment range of the SPAN pot into ten equal 10% steps across 100% of the input Signal Span.

SPAN Adjust Header position	1	2	3	4	5	1	2	3	4	5
SPAN Pot %	10%	10%	10%	10%	10%	10%	10%	10%	10%	10%
Signal Span %	10%	20%	30%	40%	50%	60%	70%	80%	90%	100%

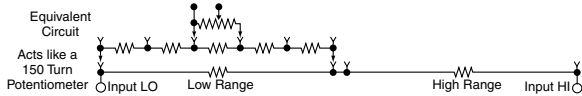

Installation Guidelines

1. Install and wire meter per local applicable codes/regulations, the particular application, and good installation practices.
2. Install meter in a location that does not exceed the maximum operating temperature and that provides good air circulation.
3. Separate input/output leads from power lines to protect the meter from external noise. Input/output leads should be routed as far away as possible from contactors, control relays, transformers and other noisy components. Shielding cables for input/output leads is recommended with shield connection to earth ground near the meter preferred.
4. A circuit breaker or disconnect switch is required to disconnect power to the meter. The breaker/switch should be in close proximity to the meter and marked as the disconnecting device for the meter or meter circuit. The circuit breaker or wall switch must be rated for the applied voltage (e.g., 120VAC or 240VAC) and current appropriate for the electrical application (e.g., 15A or 20A).
5. See *Case Dimensions* section for panel cutout information.
6. See *Connector Pinouts* section for wiring.
7. Use 28-12 AWG wiring, minimum 90°C (HH) temperature rating. Strip wire approximately 0.3 in. (7-8 mm).
8. Recommended torque on all terminal plug screws is 4.5 lb-in (0.51 N-m).



Decimal Point Selection

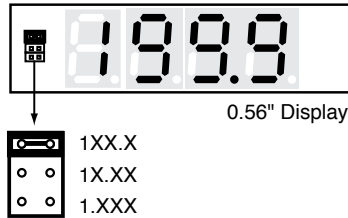

Decimal selection is made by moving the jumper to the indicated position on the header for the decimal required on the front of the display board.

Decimal Select Header

Opening Back Panel

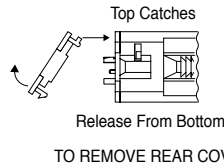

To open back panel, insert a flat screwdriver or similar instrument in both slots on the top of the case and pry open. The BX-Series meters slide out from the rear of the case as a complete assembly.

Clear Lockable Water-proof Cover

The clear lockable cover is designed to be dust and water proof to NEMA-4X, IP65 standards. The assembly consists of a base and cover with a cam hinge and key-lock fastening mechanism. An O-ring, or neoprene gasket forms a seal between the base and the panel. The cam hinge prevents the cover from closing when opened until pushed closed. The cover has a tapered recess that, when closed, forms a seal with a tapered spigot on the base. A key-lock employs a cam locking device to force the spigot into the recess, ensuring seal integrity. A safety catch keeps the cover closed even when the key is removed, and the keyhole can be used to attach a safety seal clip, preventing unauthorized opening.

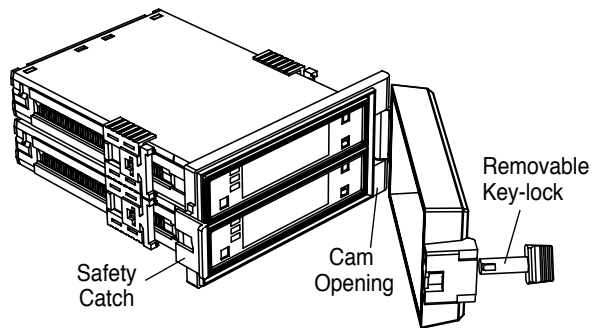

Clear Lockable NEMA 4X Splash Proof Cover
can accept two 1/16 DIN cases P/N:(OP-N4/96x48)

Face Plate Descriptors



To customize the face plate, clear adhesive label containing various popular descriptors may be ordered. Choose the descriptor desired, peel off the adhesive backing and align the descriptor in the center right of the faceplate.

P.N.: 75-DESCRIPTR

BX Case Dimensions and Panel Cutouts

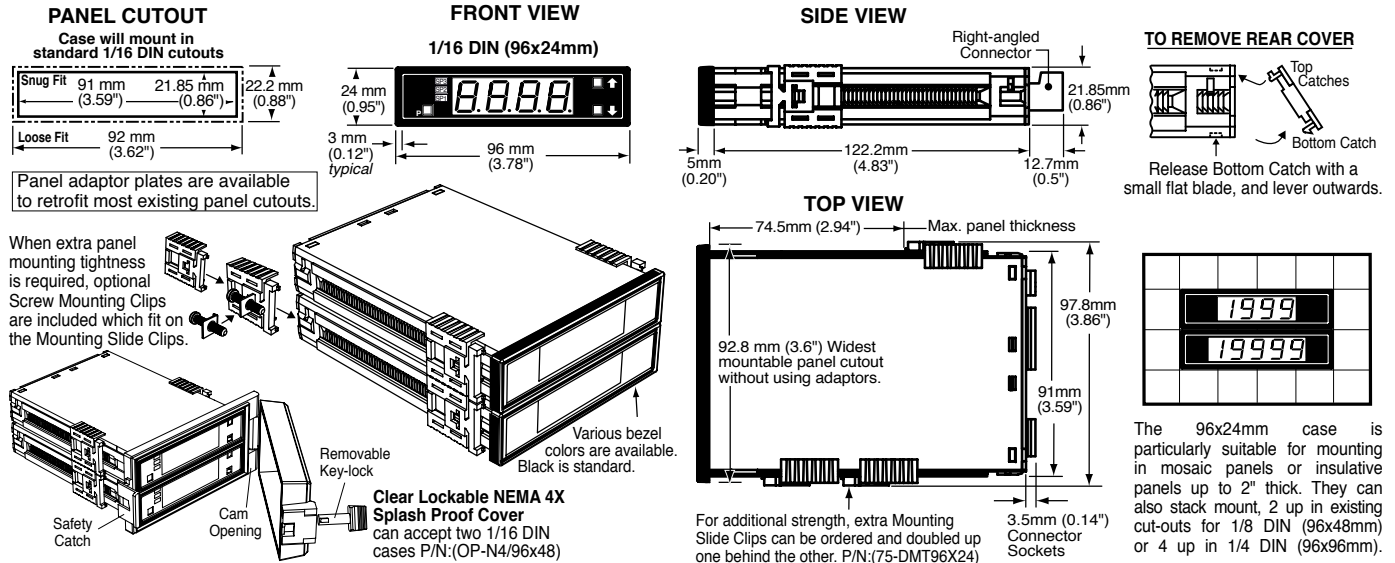

Ordering Information

Standard Options for this Model Number

Part Number	Description	List
-------------	-------------	------

► **BASIC MODEL NUMBER** Includes plug in type screw terminals, standard display and standard power supply unless optional versions are ordered.
BX-35-PROCESS . 4-20mA or 0-10 V, 96x24m, 3.5 digits

► DISPLAY

DR . . . Red LED, 0.56 inch high	
DB . . . Super-bright Red LED, 0.56 inch high	
DG . . . Green LED, 0.56 inch high	

► POWER SUPPLY

PS1 . . 85-265VAC/95-300VDC	
PS2 . . 15-48VAC/10-72VDC	

► INPUT MODULES (Partial List. See www.texmate.com)

Unless otherwise specified Texmate will ship all modules precalibrated with factory preselected ranges and/or scalings as shown in **BOLD** type.

IP01 . . Process Loop, 4-20mA(0-100.0)	\$42
IP02 . . Process Loop, 4-20mA(0-100.0) w/24VDC Exc.	\$53
ID01 . . DC-Volts, 2/20/200V/Custom w/24V DC Exc	\$32
ID05 . . DC-Volts 2/20/200/Custom V DC w/Offset and 24V Exc.	\$53

Special Options and Accessories

Part Number	Description	List
-------------	-------------	------

► SPECIAL OPTIONS (Specify Inputs or Outputs & Req. Reading)

ZR	Range Change from Standard Range shown in BOLD type	
ZS	Custom display scaling within standard ranges	

► ACCESSORIES (Specify Serial # for Custom Artwork Installation)

75-DBBZ96X24	Black Bezel for 96x24mm Case	
75-DMTC96X24	Side Slide Brackets (2 pc) - extra set, extra strength	
ART-FS-S/D	NRC for artwork & set-up Faceplate/Desc.	
ART-FS1	Install Custom Faceplate per meter - 1 color	
93-PLUG2P-DP	Extra Screw Terminal Conn., 2 Pin Power Plug	
93-PLUG2P-DR	Extra Screw Terminal Conn., 2 Pin Plug	
93-PLUG3P-DR	Extra Screw Terminal Conn., 3 Pin Plug	
93-PLUG4P-DR	Extra Screw Terminal Conn., 4 Pin Plug	
DN.CAS96X24L	Complete 96x24mm Case with bezel	
OP-MTLCLIP	Screw Mounting Clips (2 pc) to screw tighten slide brackets	
75-DTP96X24	Black Metal Trim Plate (96x24mm Case) 1 Meter	
75-DTP2X9624	Black Metal Trim Plate (96x24mm Case) 2 Meters	
75-DTP3X9624	Black Metal Trim Plate (96x24mm Case) 3 Meters	
OP-PMA/SWB-2	Switch Board Panel Mounting Adapter 2 Meters	
OP-PMA/SWB-2	Switch Board Panel Mounting Adapter 3 Meters	
75-DESCRIPTR	Clear adhesive descriptors label for face plate	

WARRANTY

Texmate warrants that its products are free from defects in material and workmanship under normal use and service for a period of one year from date of shipment. Texmate's obligations under this warranty are limited to replacement or repair, at its option, at its factory, of any of the products which shall, within the applicable period after shipment, be returned to Texmate's facility, transportation charges pre-paid, and which are, after examination, disclosed to the satisfaction of Texmate to be thus defective. The warranty shall not apply to any equipment which shall have been repaired or altered, except by Texmate, or which shall have been subjected to misuse, negligence, or accident. In no case shall Texmate's liability exceed the original purchase price. The aforementioned provisions do not extend the original warranty period of any product which has been either repaired or replaced by Texmate.

USER'S RESPONSIBILITY

We are pleased to offer suggestions on the use of our various products either by way of printed matter or through direct contact with our sales/application engineering staff. However, since we have no control over the use of our products once they are shipped, **NO WARRANTY WHETHER OF MERCHANTABILITY, FITNESS FOR PURPOSE, OR OTHERWISE** is made beyond the repair, replacement, or refund of purchase price at the sole discretion of Texmate. Users shall determine the suitability of the proDxct for the intended application before using, and the users assume all risk and liability whatsoever in connection therewith, regardless of any of our suggestions or statements as to application or construction. In no event shall Texmate's liability, in law or otherwise, be in excess of the purchase price of the product.

Texmate cannot assume responsibility for any circuitry described. No circuit patent or software licenses are implied. Texmate reserves the right to change circuitry, operating software, specifications, and prices without notice at any time.



1934 Kellogg Ave., Carlsbad, CA 92008
 Tel: 1-760-598-9899 • 1-800-TEXMATE
 Fax: 1-760-598-9828 • Email: orders@texmate.com

BX-35-PROCESS Technical Manual Copyright © 2019 Texmate Inc. All rights reserved. Published by: Texmate Inc. USA. Information in this Technical Manual is subject to change without notice due to correction or enhancement. The information described in this manual is proprietary to Texmate, Inc. and may not be copied, reproduced or transmitted, in whole or in part, in connection with the design, manufacture, or sale of apparatus, device or private label product without the express written consent of Texmate, Inc.