



LEOPARD FAMILY

TEXMATE

BL-40-TC BL-40-RTD



Optional Green LED Display

Optional Custom Faceplate

4 Digit 0.56" LEDs in a 1/16 DIN Case

A smart Temperature Controller/Transmitter for J, K, R, and T type Thermocouple and RTD inputs.
Selectable from F to C and 1° to 0.1° res.

General Features

- Thermocouple (J, K, R and T types) or RTD (Pt-100. 385 and 392 curves. 3 wire/4wire). Digitally Linearized.
- Optional isolated 16 bit analog output. User or factory scalable to 4 to 20 mA, 0 to 20 mA or 0 to 10 V across any desired digital span from ± one count to the full scale range of – 1999 to 9999 (12000 counts).
- Auto-sensing AC/DC power supply. For voltages between **85-265 V AC / 95-300 V DC (PS1)** or 15-48 V AC / 10-72 V DC (PS2).
- Standard red or optional green or super bright red 4-digit LED
- Three annunciator LEDs provide front panel alarm status indication for up to three setpoints.
- One 9 Amp Form C and one 4 Amp Form A relay, or up to three 4 Amp Form A relays are available.
- When analog output is installed, one 9 Amp Form C or two 4 Amp Form A relays can be supported.

Software Features

- Three-button programming from the front panel (UP, DOWN and PROGRAM buttons).
- Three front panel selectable ranges.
- Front panel selectable four-level brightness control of digital display.
- Three programmable setpoints.
- Relay activation can be selected to occur above (HI) or below (LO) each setpoint.
- Hysteresis setting for all three setpoints. Delay on make and delay on break for SP1 and SP2.

Input Module Compatibility

There are 2 different Plug-in Modular Input Signal Conditioners for this specialized temperature only member of the Leopard Family. IT10 is for J, K, T and R thermocouples. IT11 is for 3 wire/4 wire Pt-100 RTD inputs.

Specifications

Input Specs:.....Depends on input signal conditioner
A/D Converter:.....14 bit single slope
Accuracy:.....±(0.05% of reading + 2 counts)
Temp. Coeff.:.....100 ppm/°C (Typical)
Warm up time:.....2 minutes
Conversion Rate:.....5 conversions per second (Typical)
Display:.....**4 digit 0.56" Red LED display (std)**,
 0.56" Green or Super Bright Red (optn).
 Range –1999 to 9999 counts.
Polarity:.....Assumed positive. Displays – negative
Decimal Selection:.....Automatic by resolution select XXX·X
Positive Overage:..Top segments of digital display flash
Negative Overage: Bottom segments of digital display flash
Relay Output:.....Three 4 Amp Form A relays or one 9 Amp Form C, and one 4 Amp Form A relay.
Analog Output:.....Isolated 16 bit user scalable mA or V
 OIC (mA out).....4-20 mA @ 0 to 500Ω max loop resistance
 OIV (volts out)..... 0-10 V DC @ 500 Ω or higher resistance
Power Supply:.....AC/DC Auto sensing wide range supply
PS1 (std)**85-265 VAC / 95-300 VDC @ 2.5W max 3.2W**
PS215-48 VAC / 10-72 VDC @ 2.5W max 3.2W
Operating Temp.:.....0 to 50 °C
Storage Temp.:.....–20 °C to 70 °C.
Relative Humidity:95% (non condensing)
Case Dimensions: 1/16 DIN, Bezel: 96x24mm (3.78"x0.95")
 Depth behind bezel 122.2 mm (4.83")
 Plus 12.7mm (0.5") for Right-angled connector.
Weight:.....7 oz., 9 oz when packed

Index

Brightness Selection.....5	Controls and Indicators.....2	Ordering Information.....9	Specifications.....1
Calibration Procedure.....4	Digital Span Selection for Analog Range.....2	Pin Descriptions.....7	Thermocouple or RTD Sensor Type Selection.....4
Case Dimensions.....8	Output.....5	Setpoint Setting & Relay Configuration.....6	Two Point Analog Output Range Setting and Calibration.....5
Component Layout.....8	General Features.....1	Mode.....6	
Connector Pinouts.....7	Glossary of Programming Symbols.....2	Software Features.....1	
Connectors.....7	Input Module Compatibility.....1	Software Logic Tree.....3	

Front Panel Buttons

Program Button

The **P** button is used to move from one program step to the next. When pressed at the same time as the **↑** button, it initiates the **calibration mode**. When pressed at the same time as the **↓** button, it initiates the **setpoint setting mode**.

Up Button

When in the operational display, pressing the **↑** button alone allows you to view, but not change, the setting of **setpoint 1**.

When in the **calibration mode** or the **setpoint setting mode** the **↑** button is used to increase the value of the displayed parameter.

Down Button

When in the operational display, pressing the **↓** button alone allows you to view, but not change, the setting of **setpoint 2**.

When in the **calibration mode** or the **setpoint setting mode** the **↓** button is used to decrease the value of the displayed parameter.



Glossary of Programming Symbols

To explain software programming procedures, logic diagrams are used to visually assist in following the programming steps. The following symbols are used throughout the logic diagrams to represent the buttons and indicators on the meter:

Symbol	Explanation
	This symbol represents the OPERATIONAL DISPLAY.
	This is the PROGRAM button.
	This is the UP button.
	This is the DOWN button.
	When a button is shown, press and release it to go onto the next step in the direction indicated by the arrow. When two or more buttons are shown, each with an arrow, this indicates that there is a number of programming choices.
	When two buttons are shown side by side and enclosed by a dotted line, they must be pressed at the same time then released to go onto the next programming step.
	If the display is shown with XXXX it means the value displayed will be the previously set value. When a number is shown it indicates the initial factory default setting or a specific "example number".

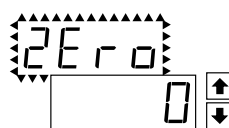

When two displays are shown together with bursts, this indicates that the display is toggling (flashing) between the name of the function and the value.

[Span]
[10000]

Text or numbers shown between square brackets in a procedure indicate the programming code name of the function or the value displayed on the meter display.

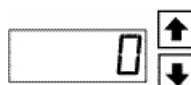

When the **↑** and **↓** buttons are shown together, the display value can be increased by pressing and releasing the **↑** button or decreased by pressing and releasing the **↓** button.

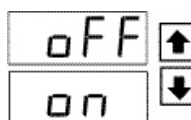

When the **↑** and **↓** buttons are shown with two displays, either display can be selected by pressing and releasing the **↑** or **↓** buttons.

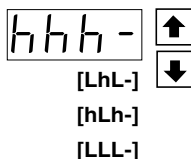

When there are more than two display selections they are shown in brackets below the first display and are also selectable by pressing and releasing the **↑** or **↓** buttons.

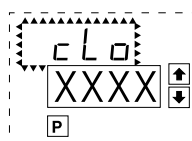

A dotted box indicates these functions are omitted or bypassed when the related hardware is not present

Software Logic Tree

The BL-40-TC and BL-40-RTD are an intelligent meter with a hierarchical software structure designed for easy programming and operation, as shown below in the software logic tree.

After the meter has been powered up, the four digits light up for three seconds and then settle to the operational display indicating the input signal.

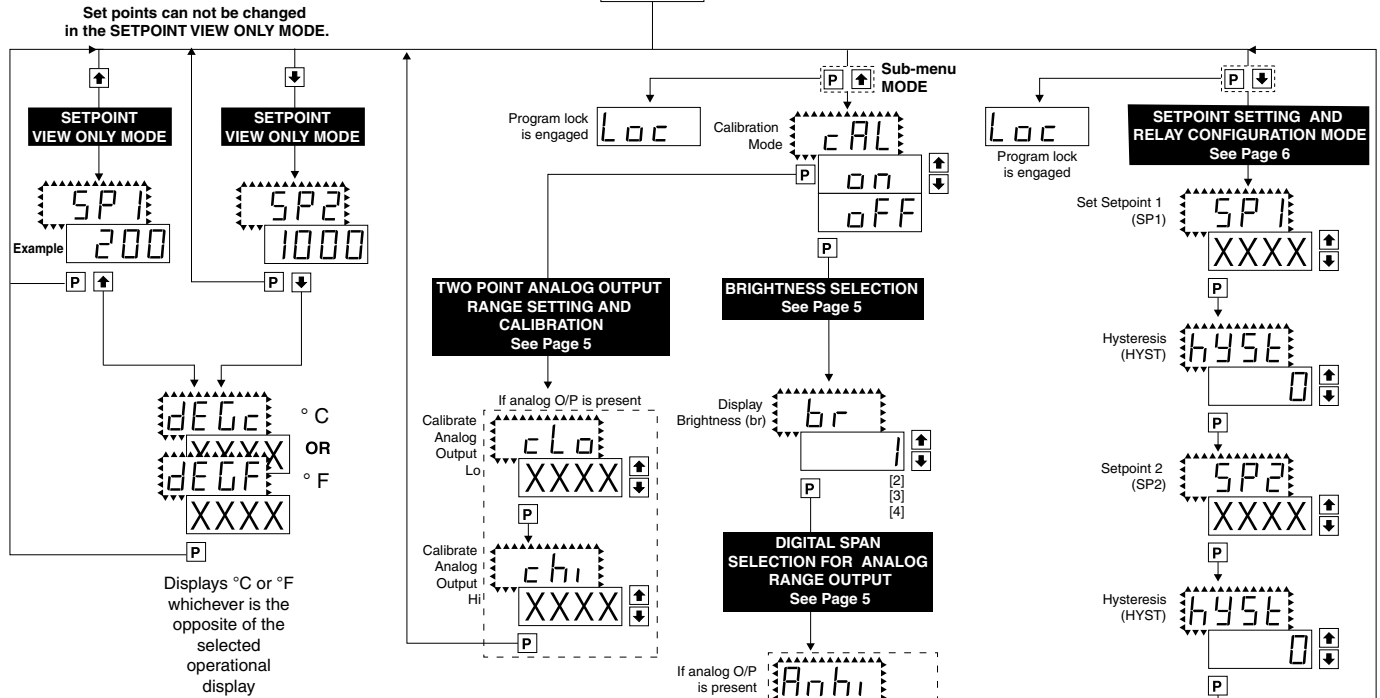

Sensor Range Table

Input Sensor	Resolution	°C Range	°F Range
J T/C	1°	-120 to 760°C	-200 to 1400°F
	0.1°	-120 to 530°C	-199.9 to 999.9°F
K T/C	1°	-120 to 1370°C	-200 to 2500°F
	0.1°	-120 to 530°C	-199.9 to 999.9°F
R T/C	1°	0 to 1760°C	32 to 3210°F
	0.1°	0 to 530°C	32 to 999.9°F
T T/C	1°	-120 to 400°C	-200 to 750°F
	0.1°	-120 to 400°C	-199.9 to 750.0°F
100Ω RTD (385 curve)	1°	-200 to 800°C	-200 to 1470°F
	0.1°	-199.9 to 530°C	-199.9 to 999.9°F
100Ω RTD (392 curve)	1°	-200 to 800°C	-200 to 1470°F
	0.1°	-199.9 to 530°C	-199.9 to 999.9°F

15 Second Program Timeout

The meter has a 15 second program timeout. If no buttons are pressed for 15 seconds, at any stage of the programming sequence the meter will exit the programming mode and return to the operational display. Any program changes that were made prior to pressing the [P] button in the preceding step will not be saved.

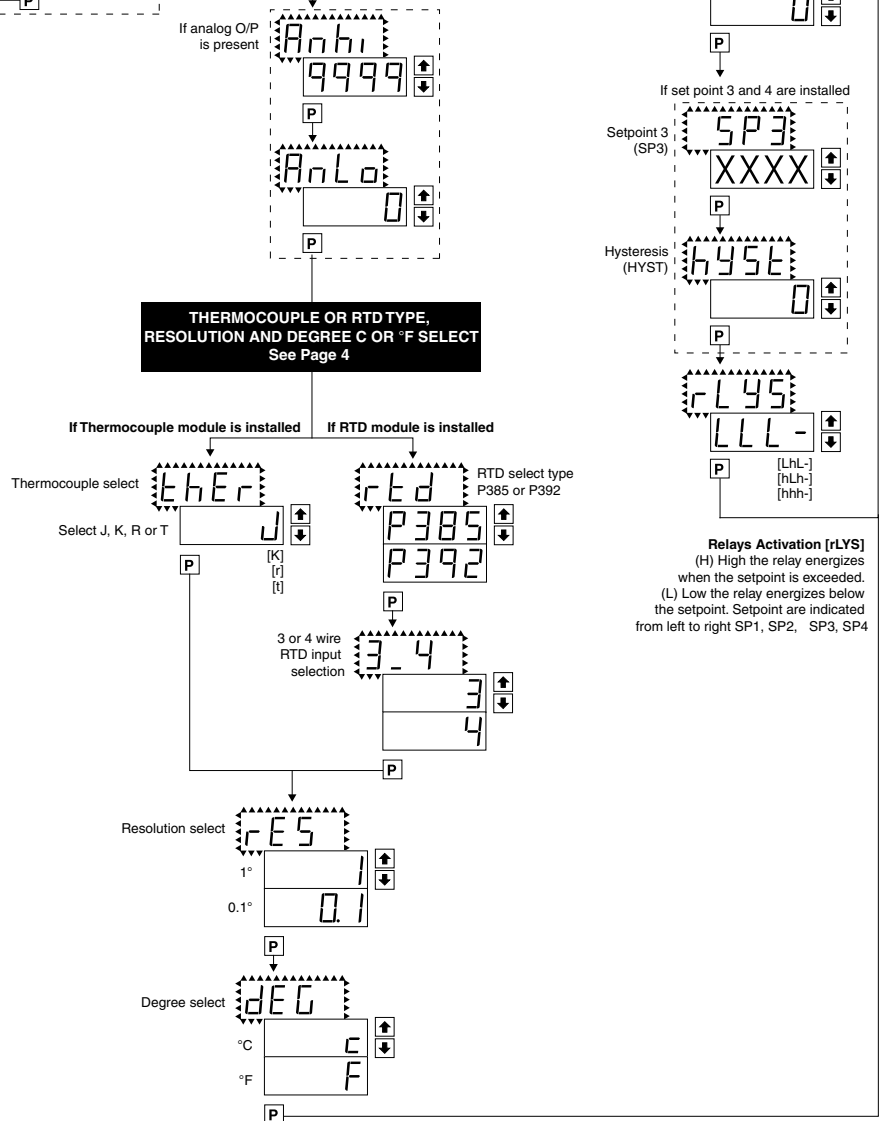

Relays Activation [LYS]
 (H) High the relay energizes when the setpoint is exceeded.
 (L) Low the relay energizes below the setpoint. Setpoint are indicated from left to right SP1, SP2, SP3, SP4

Thermocouple or RTD Sensor Type Selection

STEP A Enter the Sensor Type Selection Mode Through the Sub Menu [CAL] [oFF]

- 1) Press the **[P]** and **[↕]** buttons at the same time. Display toggles between [CAL] and [oFF].
- 2) Press the **[P]** button. Display toggles between [Br] and the previous [Br] setting.
- 3) Press the **[P]** button. Display toggles between [AnLo] and the previous [AnLo] setting (if analog output option is installed).
- 4) Press the **[P]** button and depending on the module installed the display will either toggle between [thEr] and the thermocouple selected [J], [K], [R] or [T] or [RTD] and the RTD type selection [P385] or [P392].

STEP B Sensor Type Selection

- 1) Using the **[↕]** and **[↴]** buttons, adjust the display to the desired sensor type.
- 2) Press the **[P]** button. Display toggles between [rES] resolution select and previous [rES] setting.

STEP C Set the Resolution

- 1) Using the **[↕]** and **[↴]** buttons, adjust the display to the desired resolution [rES] value.
- 2) Press the **[P]** button. Display toggles between [dEG] and previous [dEG] selection.

STEP D Selection of Degree C or Degree F

- 1) Using the **[↕]** and **[↴]** buttons, adjust the display to either °C or °F.
- 2) Press the **[P]** button. The meter exits the sensor type selection mode and returns to the operational display.

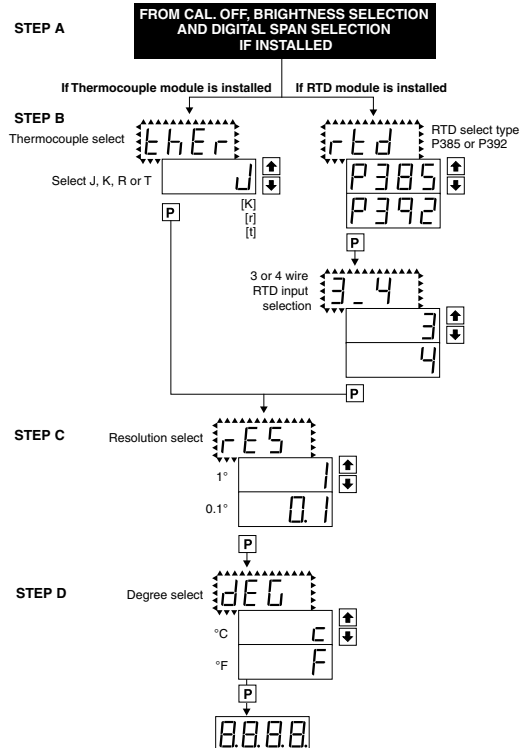

Calibration Procedure

IT10 Thermocouple Input Signal Conditioner installed.

1. Unplug the connector plugs from the meter. Remove the case back panel and slide the PCB out of the case.
2. Select the appropriate header jumper position depending on which thermocouple is to be used. Thermocouple types J, K, R and T are supported. This sets up the correct cold junction compensation.
3. Insert the PCB back into the case. Snap the back panel back into the case. Apply power to the meter.
4. Enter the program mode and select the type of thermocouple (J, K, R, T), the resolution (0.1° or 1°) and the display units °C or °F). See the Software Logic Tree on Page 3 of the data sheet for details.
5. Connect a thermocouple simulator to the meter inputs. Apply an input corresponding to 0° and adjust the ZERO Potentiometer to make the display read 0.
6. Apply an input corresponding to the maximum reading of the thermocouple and adjust the SPAN Potentiometer to make the display read correctly.
7. The DL-40H is now calibrated and ready for use. Calibration will have to be performed again if the thermocouple type is changed.

IT11 RTD Input Signal Conditioner installed.

1. Enter the program mode and select the type of RTD (385 or 392 curve and 3-wire/ 4-wire), the resolution (0.1° or 1°) and the display units °C or °F). See the Software Logic Tree on Page 3 of the data sheet for details.
2. Connect an RTD simulator to the meter inputs. Apply an input corresponding to 0° and adjust the ZERO Potentiometer to make the display read 0.
3. Introduce a lead resistance of 10Ω in each lead. Adjust the Lead Resistance Compensation potentiometer to make the display again reads 0.
4. The DL-40H is now calibrated and ready for use. Calibration will have to be performed again if the RTD type is changed.

IT10: Thermocouple, J/K/R/T, Selectable C/ F, 1/0.1

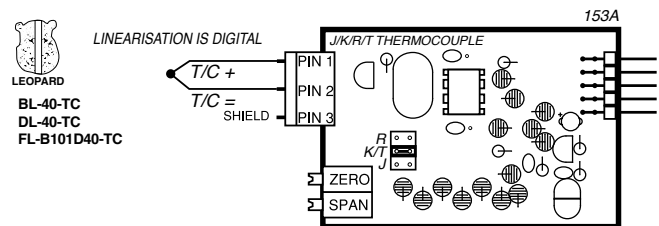

IT11: RTD, 100 Pt. Select 3/4-wire, C/F, 1/0.1

IT15: RTD, 1000 Pt. Select 3/4-wire, C/F, 1/0.1

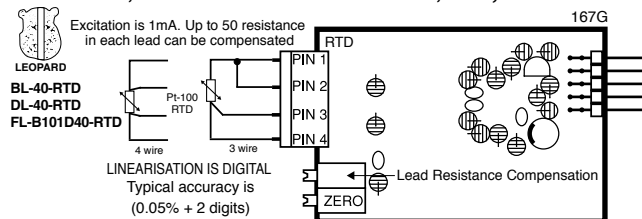

Two Point Analog Output Range Setting and Calibration

STEP A Enter the Calibration Mode

- 1) Press the **P** and **↑** buttons at the same time. Display toggles between [cAL] and [oFF] if the Analog Output option is installed. If at this point the display skips directly to toggle between [Br] and the previous [Br] setting (STEP D) then the software is detecting that the optional analog output hardware is NOT installed.
- 2) Press the **↑** or **↓** button. Display changes from [oFF] to [on].

STEP B Enter the Analog [oUT] Output Mode

- 1) Press the **P** button. Display toggles between [cLo] and an internal scale factor.

STEP C Set or Calibrate the [cLo] Low Analog Output Range

- 1) Select the voltage or current loop output header position on the output module. (See Component Layout on page 9).
- 2) Connect a multimeter to pins 8 and 9 on the output module. (See Rear Panel Pinouts on page 8). Using the **↑** and **↓** buttons, adjust the analog output to the desired low value as shown on the multimeter display. cLo may be adjusted to any value from -0.3 mA to 17 mA (mA output selected) or from -0.6 V to 8 V (volt output selected)
- 3) Press the **P** button. Display toggles between [chi] and an internal scale factor.

STEP D Set or Calibrate the [chi] High Analog Output Range

- 1) Using the **↑** and **↓** buttons, adjust the analog output to the desired high value as shown on the multimeter display. chi may be adjusted to any value from 17 mA to 21 mA (mA output selected) or from 8 V to 10.3 V (volt output selected)
- 2) Press the **P** button. The display exits the calibration mode and returns to the operational display.

Note: Having established the Low and High range of the analog output, the digital span can now be selected which will set the two digital points between which the analog output will occur. (See Digital Span Selection below).

Brightness Selection

STEP D Enter the Brightness Mode Through the Sub Menu [cAL] [oFF]

- 1) Press the **P** and **↑** buttons at the same time. Display toggles between [cAL] and [oFF].
- 2) Press the **P** button. Display toggles between [Br] and the previous [Br] setting.

STEP E Set the Display Brightness

- 1) Using the **↑** and **↓** buttons, adjust the display to the desired brightness setting (4 is the brightest setting).
- 2) Press the **P** button. Display brightness changes to new setting and display toggles between [AnHi] and the previous [AnHi] setting.

Digital Span Selection for Analog Range Output

STEP F Setting the Digital Span Point for Analog High Output

- 1) Using the **↑** and **↓** buttons, adjust the display to the desired digital value which sets the point at which the selected analog high output range will occur.
- 2) Press the **P** button. Display toggles between [AnLo] and previous [AnLo] setting.

STEP G Setting the Digital Span Point for Analog Low Output

- 1) Using the **↑** and **↓** buttons, adjust the display to the desired digital value which sets the point at which the selected analog low output range will occur.
- 2) Press the **P** button. The display exits the calibration mode and returns to the operational display.

Note: Any two digital scale points from -1999 to 9999 can be selected. The digital scale points for analog high and analog low can be reversed for reversed 20-4 mA output. The span of the digital scale can be as small as two counts however small spans cause the 16 bit D to A to increment in stair case steps.

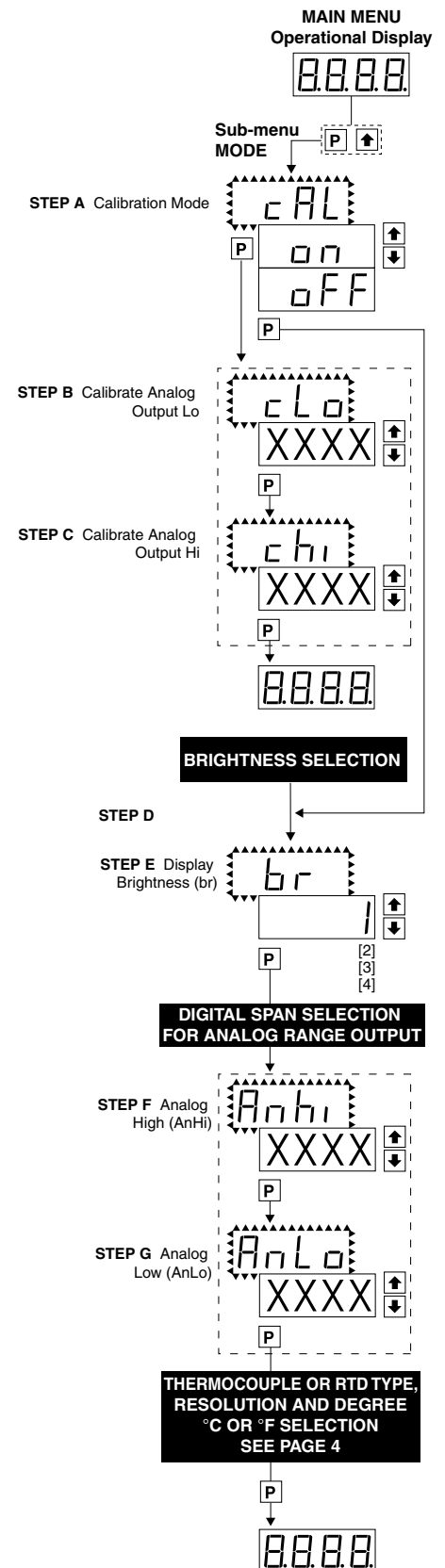

Setpoint Setting and Relay Configuration Mode

The following programming steps are required to enter the setpoint values and configure the relay functions in a meter with four relays using four setpoints. Generally if less than four relays are installed the software auto detects missing relays and deletes reference to them from the menu. In some cases setpoints without relays are operational for display only purposes.

STEP A Enter the Setpoint Mode

- 1) Press the **P** and **↓** buttons at the same time.
Display toggles between [SP1] and the previous [SP1] setting.

STEP B Set Setpoint 1 (SP1)

- 1) Using the **↑** and **↓** buttons, adjust the display to the desired SP1 value.
- 2) Press the **P** button. Display toggles between [HYSt] and the previous [HYSt] setting.

STEP C Set the Hysteresis Setting for Setpoint 1

- 1) Using the **↑** and **↓** buttons, adjust the display to the desired hysteresis [HYSt] value.
- 2) Press the **P** button. Display toggles between [SP2] and the previous [SP2] setting.

NOTE: Half of the Hysteresis value selected is applied above and below the setpoint.

STEP D Set Setpoint 2 (SP2)

- 1) Using the **↑** and **↓** buttons, adjust the display to the desired SP2 value.
- 2) Press the **P** button. Display toggles between [HYSt] and the previous [HYSt] setting.

STEP E Set the Hysteresis Setting for Setpoint 2

- 1) Using the **↑** and **↓** buttons, adjust the display to the desired hysteresis [HYSt] value.
- 2) Press the **P** button. Display toggles between [SP3] and the previous [SP3] setting.

STEP F Set Setpoint 3 (SP3)

- 1) Using the **↑** and **↓** buttons, adjust the display to the desired SP3 value.
- 2) Press the **P** button. Display toggles between [HYSt] and the previous [HYSt] setting.

STEP G Set the Hysteresis Setting for Setpoint 3

- 1) Using the **↑** and **↓** buttons, adjust the display to the desired hysteresis [HYSt] value.
- 2) Press the **P** button. Display toggles between [HYSt] and the previous [HYSt] setting.

STEP H Set Relay Activation mode [rLYS]

(H) High the relay energizes when the setpoint is exceeded. (L) Low the relay energizes below the setpoint. The setpoint is indicated from left to right SP1, SP2, SP3.

- 1) Using the **↑** and **↓** buttons, adjust the reading on the display to the desired relay settings: [LLL-], [LHL-], [LLH-], [HHH-].
If only 2 relays installed [LH] [HL] [HH] [LL].
- 2) Press the **P** button.
The meter exits the setpoint mode and returns to the operational display.

The Setpoint Relay programming mode is now complete.

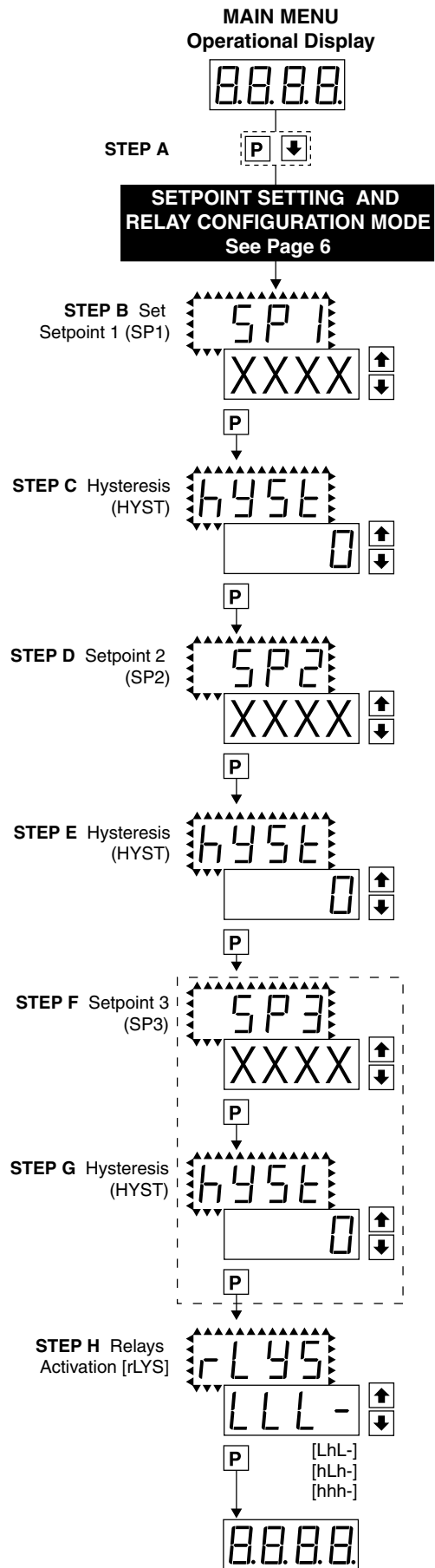

Connector Pinouts

This meter comes standard with screw terminal plug connections.

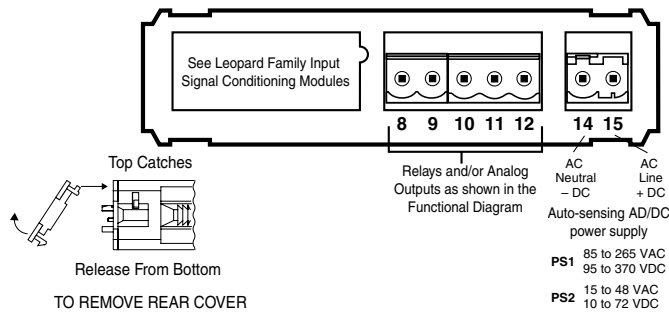

Connectors

This meter uses plug-in type screw terminal connectors for all input and output connections. The power supply connections (pins 14 and 15) have a unique plug and socket outline to prevent cross connection. The main board uses standard right-angled connectors.

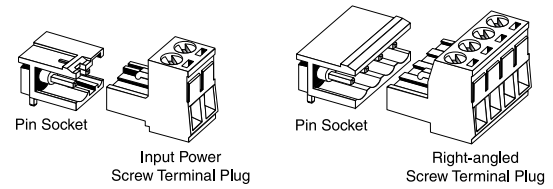

WARNING: AC and DC input signals and power supply voltages can be hazardous. Do Not connect live wires to screw terminal plugs, and do not insert, remove or handle screw terminal plugs with live wires connected.

Pin Descriptions

Pins 1 to 6 – Input Signal

Pins 1 to 6 are reserved for the input signal conditioner. See the data sheet for the selected input signal conditioner.

Pins 8 to 12 – Relay and Analog Output Pins

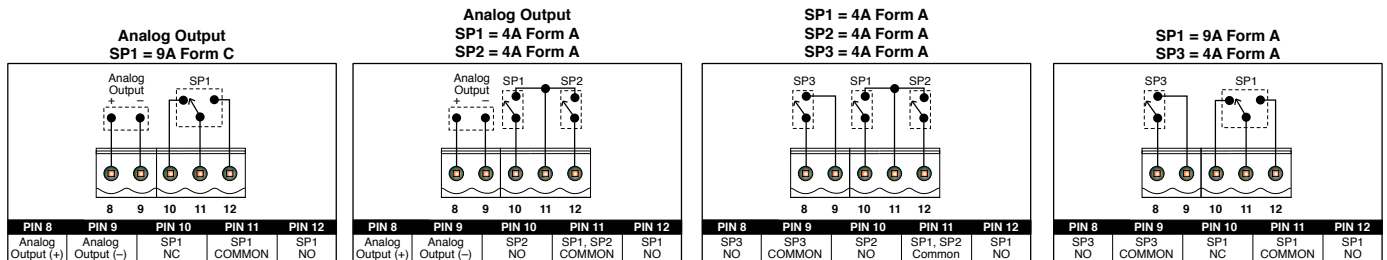

Pins 14 and 15 – AC/DC Power Input

Auto sensing AC/DC power supply. For voltages between 85-265 VAC or 95-300 VDC (PS1).

Pin 14 & Pin 15 - AC/DC Power Input: These pins are the power pins of the meter and they only accept a special polarized screw terminal plug that can not be inserted into any other input socket. The standard meter has a auto sensing AC/DC power supply that operates from 85-265 VAC/95-300 VDC (PS1 Std). An optional isolated low voltage power supply that operates from 15-48 VAC/10-72 VDC (PS2) is also available.

Installation Guidelines

Installation

1. Install and wire meter per local applicable codes/regulations, the particular application, and good installation practices.

2. Install meter in a location that does not exceed the maximum operating temperature and that provides good air circulation.

3. Separate input/output leads from power lines to protect the meter from external noise. Input/output leads should be routed as far away as possible from contactors, control relays, transformers and other noisy components. Shielding cables for input/output leads is recommended with shield connection to earth ground near the meter preferred.

4. A circuit breaker or disconnect switch is required to disconnect power to the meter. The breaker/switch should be in close proximity to the meter and marked

as the disconnecting device for the meter or meter circuit. The circuit breaker or wall switch must be rated for the applied voltage (e.g., 120VAC or 240VAC) and current appropriate for the electrical application (e.g., 15A or 20A).

5. See *Case Dimensions* section for panel cutout information.

6. See *Connector Pinouts* section for wiring.

7. Use 28-12 AWG wiring, minimum 90°C (HH) temperature rating. Strip wire approximately 0.3 in. (7-8 mm).

8. Recommended torque on all terminal plug screws is 4.5 lb-in (0.51 N-m).



Component Layout

MAIN BOARD

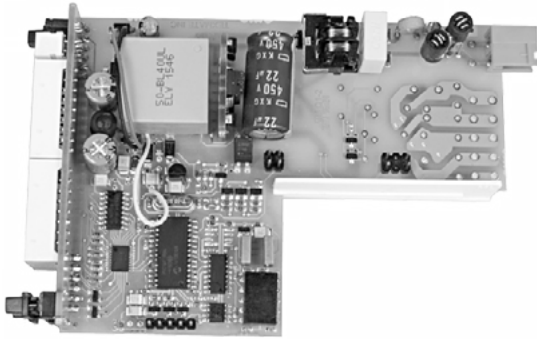

MAIN BOARD HI VOLTAGE

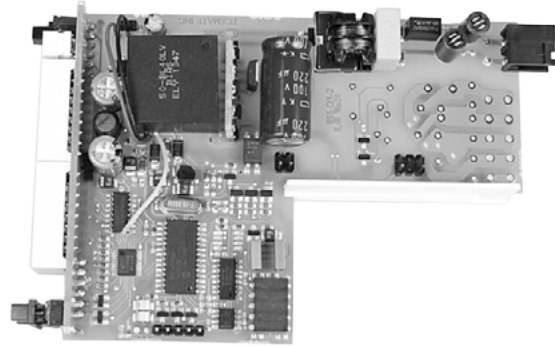

MAIN BOARD LOW VOLTAGE

Thermocouple

IT10 Thermocouple, J/K/R/T Selectable C/F, 1/0.1

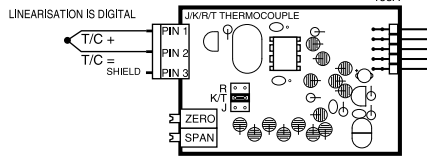
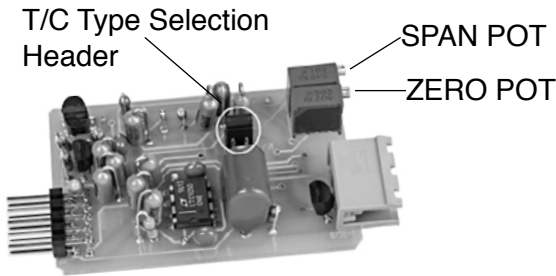

RTD

IT11 RTD, 100Ω Pt. Selectable 3/4-wire, °C/°F, 1°/0.1°, 385/392

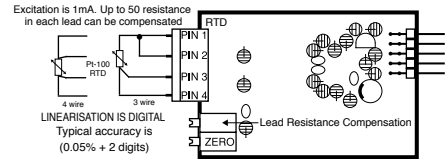
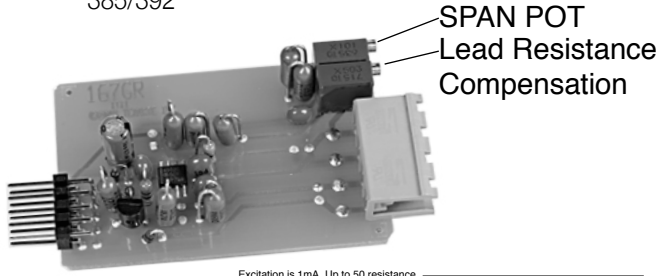

Program Lockout Header

This header disable any programming function.



To access the header, you must remove meter from case. Please see "Connector Pinouts" on page 7 for the instruction.

Case Dimensions

PANEL CUTOUT

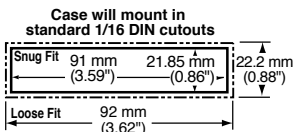

Panel adaptor plates are available to retrofit most existing panel cutouts.

FRONT VIEW

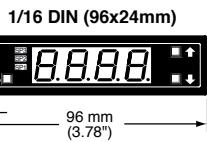

SIDE VIEW

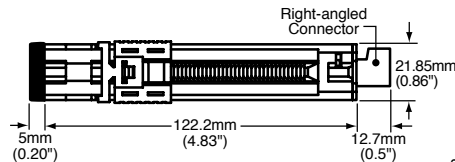

TO REMOVE REAR COVER

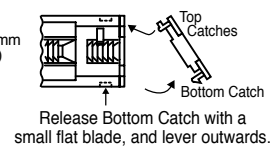

When extra panel mounting tightness is required, optional Screw Mounting Clips are included which fit on the Mounting Side Clips.

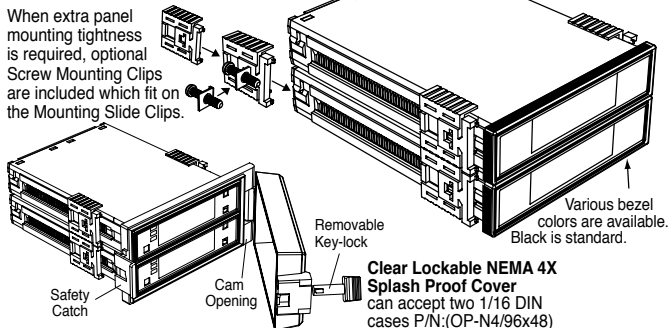

TOP VIEW

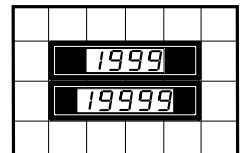
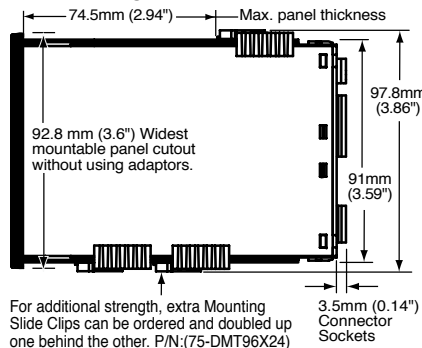

The 96x24mm case is particularly suitable for mounting in mosaic panels or insulative panels up to 2" thick. They can also stack mount, 2 up in existing cut-outs for 1/8 DIN (96x48mm) or 4 up in 1/4 DIN (96x96mm).

Ordering Information

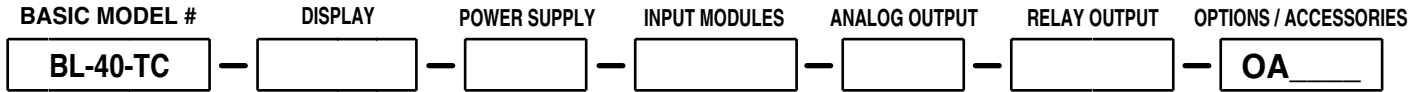

Add to the basic model number the order code suffix for each standard option required. The last suffix is to indicate how many different special options and or accessories that you may require to be included with this product.

Ordering Example: BL-40H-DR-PS1-IT10-OIC-R1-OA2, the 2 OA's are, CR-CHANGE and a 75-DBBZ96X24

► **BASIC MODEL NUMBER**

- BL-40-TC ... Termocouple, J,K,R and T Type, 96x24mm, 4 Digit
- BL-40-TC ... RTD, 100Ω Pt, 96x24mm, 4 Digit

Standard Options for this Model Number

Order Code Suffix	Description	List
► DISPLAY		
DR	Red LED, 0.56 inch high	
DB	Super-bright Red LED, 0.56 inch high	
DG	Green LED, 0.56 inch high	

► **POWER SUPPLY**

- PS185 - 265VAC / 95 - 370VDC
- PS215 - 48VAC / 10 - 72VDC

► **INPUT MODULES (Partial List. See www.texmate.com)**

Unless otherwise specified Texmate will ship all modules precalibrated with factory preselected ranges and/or scalings as shown in **BOLD** type.

- IT10 . . . Thermocouple, J/K/R/T, Selectable °C/°F, **1°/0.1°**
- IT11 . . . RTD, 100Ω Pt. Selectable 3/4-wire, °C/°F, **1°/0.1°**, 385/392

► **ANALOG OUTPUT***

- OIC . . . Isolated analog 4-20mA (with a Max. Two-5A Form A Relays) .
 - OIV . . . Isolated analog 0-10VDC (with a Max. Two-5A Form A Relays) .
- *Note: When either of the Analog Output options is installed, only the R1, R2 and R11 Relay Output options can be co-installed (see below).

► **RELAY OUTPUT**

- R1 . . . Single 5A Form A Relay
 - R2 . . . Dual 5A Form A Relays
 - R3 . . . Three 5A Form A Relays; SP1 & SP2 common**
 - R11 . . Single 10A Form C Relay
 - R16 . . Single 10A Form C & Single 5A Form A Relays**
- **R3 & R16 cannot be co-installed with Analog Output options.

Special Options and Accessories (OA's)

Part Number	Description	List
► SPECIAL OPTIONS (Specify Inputs or Outputs & Req. Reading)		
ZR	Range Change from Standard Range shown in BOLD type. .	
ZS	Custom display scaling within standard ranges.	
ZS-AO	Custom scaling of analog output	

► **ACCESSORIES**

- 75-DBBZ96X24. Black Bezel for 96x24mm Case.
- 75-DMTC96X24 Side Slide Brackets (2 pc) - extra set, extra strength . . .
- ART-FS-S/D. NRC for artwork & set-up Faceplate/Desc.
- ART-FS1 Install Custom Faceplate per meter - 1 color
- 93-PLUG2P-DP. Extra Screw Terminal Conn., 2 Pin Power Plug
- 93-PLUG2P-DR Extra Screw Terminal Conn., 2 Pin Plug.
- 93-PLUG3P-DR Extra Screw Terminal Conn., 3 Pin Plug.
- 93-PLUG4P-DR Extra Screw Terminal Conn., 4 Pin Plug.
- DN.CAS96X24L Complete 96x24mm Case with bezel
- OP-MTLCLIP Screw Mounting Clips (2 pc) to screw tighten slide brackets .
- 75-DTP96X24 . . . Black Metal Trim Plate (96x24mm Case) 1 Meter
- 75-DTP2X9624 . . . Black Metal Trim Plate (96x24mm Case) 2 Meters
- 75-DTP3X9624 . . . Black Metal Trim Plate (96x24mm Case) 3 Meters
- OP-PMA/SWB-2 Switch Board Panel Mounting Adapter 2 Meters
- OP-PMA/SWB-2 Switch Board Panel Mounting Adapter 3 Meters

*Many other options and accessories are available. See full price list for more data
Prices subject to change without notice.*

WARRANTY

Texmate warrants that its products are free from defects in material and workmanship under normal use and service for a period of one year from date of shipment. Texmate's obligations under this warranty are limited to replacement or repair, at its option, at its factory, of any of the products which shall, within the applicable period after shipment, be returned to Texmate's facility, transportation charges pre-paid, and which are, after examination, disclosed to the satisfaction of Texmate to be thus defective. The warranty shall not apply to any equipment which shall have been repaired or altered, except by Texmate, or which shall have been subjected to misuse, negligence, or accident. In no case shall Texmate's liability exceed the original purchase price. The aforementioned provisions do not extend the original warranty period of any product which has been either repaired or replaced by Texmate.

USER'S RESPONSIBILITY

We are pleased to offer suggestions on the use of our various products either by way of printed matter or through direct contact with our sales/application engineering staff. However, since we have no control over the use of our products once they are shipped, **NO WARRANTY WHETHER OF MERCHANTABILITY, FITNESS FOR PURPOSE, OR OTHERWISE** is made beyond the repair, replacement, or refund of purchase price at the sole discretion of Texmate. Users shall determine the suitability of the product for the intended application before using, and the users assume all risk and liability whatsoever in connection therewith, regardless of any of our suggestions or statements as to application or construction. In no event shall Texmate's liability, in law or otherwise, be in excess of the purchase price of the product.

Texmate cannot assume responsibility for any circuitry described. No circuit patent or software licenses are implied. Texmate reserves the right to change circuitry, operating software, specifications, and prices without notice at any time.



1934 Kellogg Ave., Carlsbad, CA 92008
Tel: 1-760-598-9899 • 1-800-TEXMATE
Fax: 1-760-598-9828 • Email: orders@texmate.com

BL-40-TC, BL-40-RTD Technical Manual Copyright © 2019 Texmate Inc. All rights reserved. Published by: Texmate Inc. USA. Information in this Technical Manual is subject to change without notice due to correction or enhancement. The information described in this manual is proprietary to Texmate, Inc. and may not be copied, reproduced or transmitted, in whole or in part, in connection with the design, manufacture, or sale of apparatus, device or private label product without the express written consent of Texmate, Inc.