

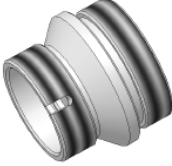

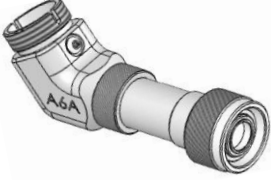

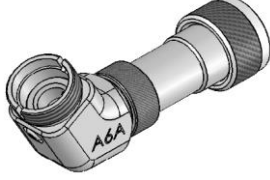







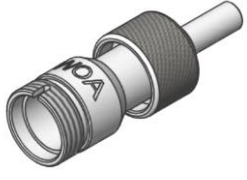
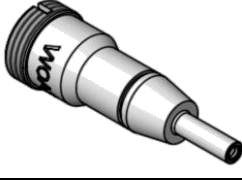
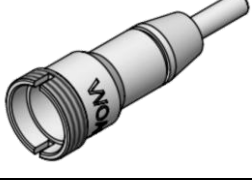

<p>Series 2 probe adapter to enable use of CI-1000 tips</p>	<p>PT2-CI/ADAPT</p>		
<p>Universal 60° angled adapter for Series 2 standard probe tips</p>	<p>PT2-U/ADAPT-A6</p>		
<p>Series 2 probe adapter to double FOV (for large diameter fiber only)</p>	<p>PT2-FOV2/ADAPT</p>		
<p>Series 2 probe adapter to enable use of non-lensed JDSU tips</p>	<p>PT2-WO/ADAPT</p>		
<p>Series 2 probe tip for JDSU 3mm tip guides (ARINC, ODC, etc.)</p>	<p>PT2-WO/ADAPT-3</p>		
<p>Series 2 60° angled probe tip for JDSU 3mm tip guides (ARINC, ODC, etc.)</p>	<p>PT2-WO/ADAPT-3A</p>		

Lightel Technologies Series 2 Probe Tips

<p>Universal 2.5mm Series 2 probe tip for PC type male connectors</p>	<p>PT2-U2.5/PC/M</p>		
<p>Universal 1.25mm Series 2 probe tip for PC type male connectors</p>	<p>PT2-U1.25/PC/M</p>		
<p>Universal 2.0mm Series 2 probe tip for PC type male connectors</p>	<p>PT2-U2.0/PC/M</p>		
<p>Series 2 probe tip for 1.6mm male PC type termini</p>	<p>PT2-TM1.6/PC/M</p>		
<p>Series 2 slim probe tip for 2.5mm male PC type termini</p>	<p>PT2-TM2.5/PC/M</p>		
<p>Series 2 probe tip for 1.25mm male ELIO connectors and termini</p>	<p>PT2-ELIO1.25/PC/M</p>		
<p>Series 2 slim probe tip for 1.25mm male LuxCis connectors and termini</p>	<p>PT2-TM1.25/PC/M</p>		
<p>Series 2 specialty probe tip for male LC PC simplex and duplex connectors</p>	<p>PT2-LC/PC/M</p>		

PC Tips

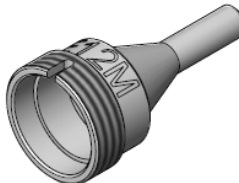
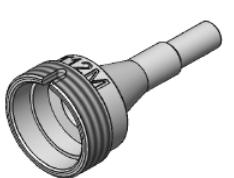
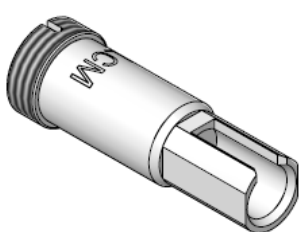
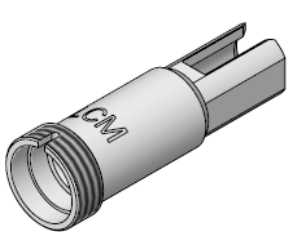



Lightel Technologies Series 2 Probe Tips

PC Tips (Cont'd)

Series 2 probe tip for Biconic connectors	PT2-BI/PC/M		
Series 2 probe tip for SC PC type female connectors	PT2-SC/PC/F		
Series 2 probe tip for SC and FC PC type female connectors	PT2-FS/PC/F		
Series 2 probe tip for ST PC type female connectors	PT2-ST/PC/F		
Series 2 probe tip for SMA 905 PC type male connectors	PT2-SMA/PC/M		
Series 2 probe tip for SMA 905 PC type female connectors	PT2-SMA/PC/F		
Series 2 probe tip for LC PC type female connectors	PT2-LC/PC/F		
Series 2 probe tip for LC PC type female connectors (square version)	PT2-LC/PC/F-1		
Series 2 probe tip for MU PC type female connectors	PT2-MU/PC/F		

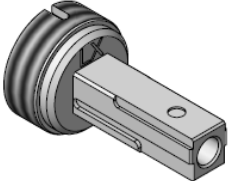
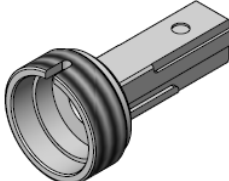
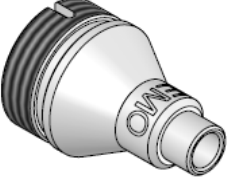
Lightel Technologies Series 2 Probe Tips

PC Tips (Cont'd)

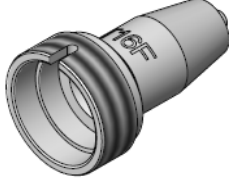
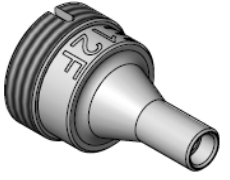
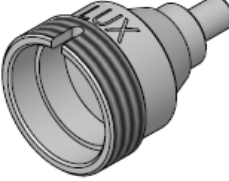
<p>Series 2 probe tip for LX.5 PC type female connectors</p>	<p>PT2-LX.5/PC/F</p>		
<p>Series 2 probe tip for female LEMO connectors</p>	<p>PT2-LEMO/PC/F</p>		
<p>Series 2 probe tip for D4 female connectors</p>	<p>PT2-D4/PC/F</p>		
<p>Series 2 probe tip for 2.0mm female PC type termini</p>	<p>PT2-TM2.0/PC/F</p>		
<p>Series 2 probe tip for 1.6mm female PC type termini</p>	<p>PT2-TM1.6/PC/F</p>		
<p>Series 2 extended probe tip for female CS®PC connectors</p>	<p>PT2-CS/PC/F-S</p>		
<p>Series 2 probe tip for 1.25mm female ELIO connectors and termini</p>	<p>PT2-ELIO1.25/PC/F</p>		
<p>Series 2 probe tip for 1.25mm female LuxCis connectors and termini</p>	<p>PT2-LUX1.25/PC/F</p>		

Lightel Technologies Series 2 Probe Tips

PC Tips (Cont'd)









<p>Series 2 probe tip for female proprietary ASML multimode 6 fiber connectors</p>	<p>PT2-MMMF/PC/F</p>		
<p>Series 2 guide and universal probe tip for male and female for 4 channel TFOCA II connectors</p>	<p>PT2-TFO2-KIT</p>		
<p>Series 2 guide for male and female for 4 channel TFOCA II connectors</p>	<p>PT2-TFO2-G</p>		
<p>Series 2 universal probe tip for male and female TFOCA connectors</p>	<p>PT2-TFO-U</p>		
<p>Series 2 guide and universal probe tip for female 2 channel ODC connectors</p>	<p>PT2-ODC/PC/KF-2</p>		
<p>Series 2 guide for female 2 channel ODC connectors</p>	<p>PT2-ODC/PC/GF-2</p>		
<p>Series 2 universal probe tip for female ODC connectors</p>	<p>PT2-ODC/PC/UF</p>		
<p>Series 2 guide and universal probe tip for female 4 channel ODC connectors</p>	<p>PT2-ODC/PC/KF-4</p>		
<p>Series 2 guide for female 4 channel ODC connectors</p>	<p>PT2-ODC/PC/GF-4</p>		

Lightel Technologies Series 2 Probe Tips

PC Tips (Cont'd)

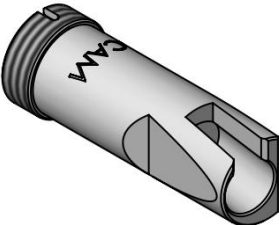
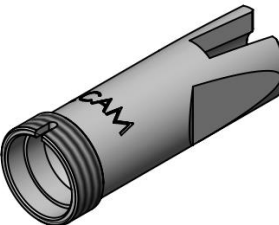
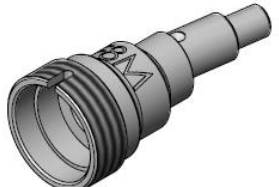
<p>Series 2 guide and universal probe tip for female 4 channel ODC connectors</p>	<p>PT2-QODC/PC/KF-2</p>		
<p>Series 2 tip female ARINC and QODC connectors</p>	<p>PT2-U/ARINC</p>		
<p>Series 2 extended probe tip for female SN® or MDC connectors</p>	<p>PT2-TR4/PC/F-S</p>		
<p>Series 2 guide for female SN® connectors</p>	<p>PT2-SN/PC/GF</p>		
<p>Series 2 extended tip kit for female SN® connectors</p>	<p>PT2-SN/PC/KF1</p>		
<p>Series 2 guide for female ODC connectors</p>	<p>PT2-MDC/PC/GF</p>		
<p>Series 2 extended tip kit for female MDC connectors</p>	<p>PT2-MDC/PC/KF1</p>		

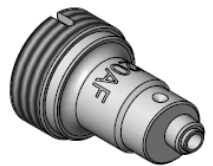









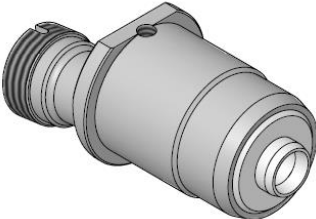

Lightel Technologies Series 2 Probe Tips

<p>Universal 2.5mm Series 2 probe tip for APC type male connectors</p>	<p>PT2-U2.5/APC/M</p>		
<p>Series 2 probe tip for FC APC type male connectors</p>	<p>PT2-FC/APC/M</p>		
<p>Universal 1.25mm Series 2 probe tip for APC type male connectors</p>	<p>PT2-U1.25/APC/M</p>		
<p>Series 2 specialty probe tip for male LC APC simplex and duplex connectors</p>	<p>PT2-LC/APC/M</p>		
<p>Series 2 probe tip for 1.25mm LEMO F8 APC type male connectors</p>	<p>PT2-LEMO1.25/APC/M</p>		
<p>Series 2 probe tip for 2.0mm APC type male termini (MIL 28876)</p>	<p>PT2-TM2.0/APC/M</p>		
<p>Series 2 probe tip for 2.0mm APC type female termini (MIL 28876)</p>	<p>PT2-TM2.0/APC/F</p>		
<p>Series 2 probe tip for SC and FC APC type female connectors</p>	<p>PT2-FS/APC/F</p>		

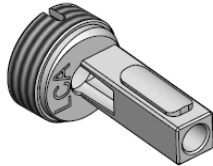
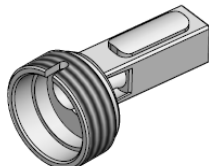
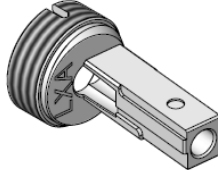
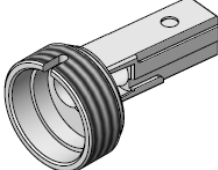

APC Tips

Lightel Technologies Series 2 Probe Tips

APC Tips (Cont'd)

<p>Series 2 probe tip for SC APC type female connectors</p>	<p>PT2-SC/APC/F</p>		
<p>Series 2 probe tip for FC APC type female connectors</p>	<p>PT2-FC/APC/F</p>		
<p>Series 2 probe tip for OptiTap® female connectors (Hardened SC)</p>	<p>PT2-OTAP/APC/F</p>		
<p>Series 2 probe tip for E2000 APC type female connectors</p>	<p>PT2-E2K/APC/F</p>		
<p>Series 2 probe tip for LC APC type female connectors</p>	<p>PT2-LC/APC/F</p>		
<p>Series 2 probe tip for LX.5 APC type female connectors</p>	<p>PT2-LX.5/APC/F</p>		
<p>Series 2 probe tip for AVIM APC type female connectors</p>	<p>PT2-AVIM/APC/F</p>		
<p>Series 2 short extended probe tip for SC APC type female connectors</p>	<p>PT2-SC/APC/F-S</p>		

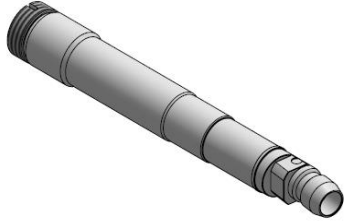
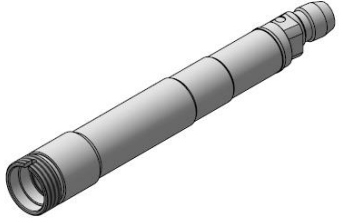
Lightel Technologies Series 2 Probe Tips

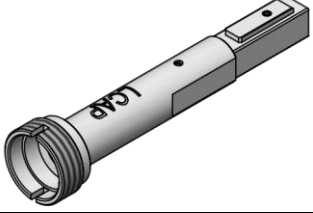
<p>Series 2 medium extended probe tip for SC APC type female connectors</p>	<p>PT2-SC/APC/F-M</p>		
<p>Series 2 short extended probe tip for LC APC type female connectors</p>	<p>PT2-LC/APC/F-SP</p>		







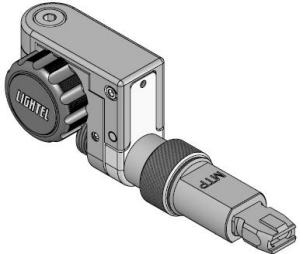
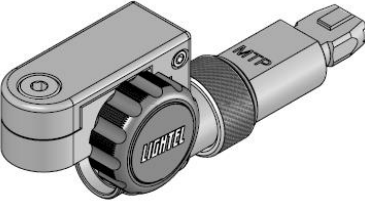
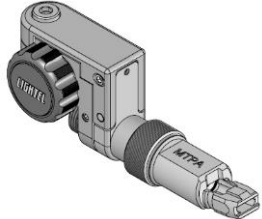
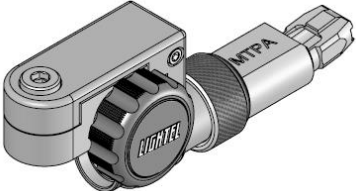
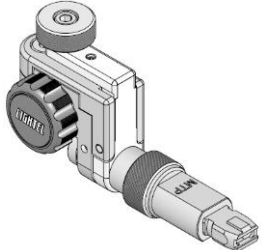
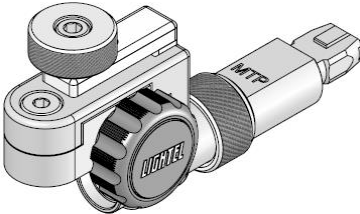
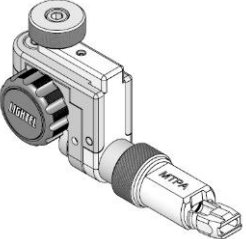
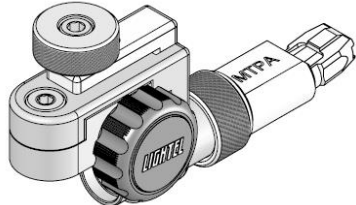
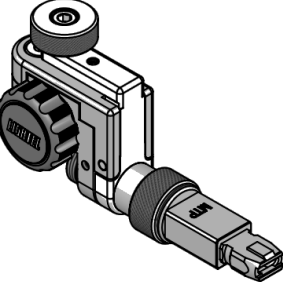
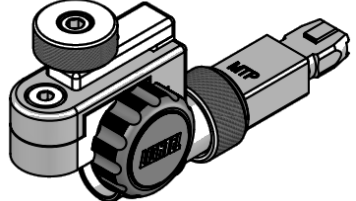
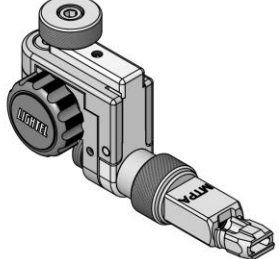
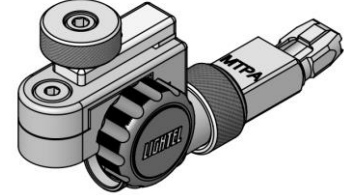

APC Tips (Cont'd)

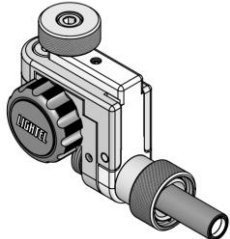
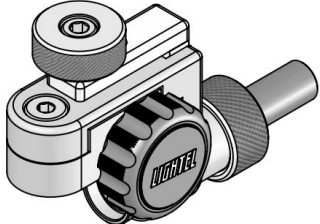
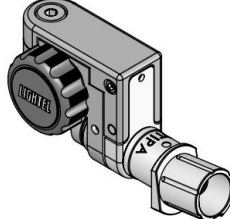
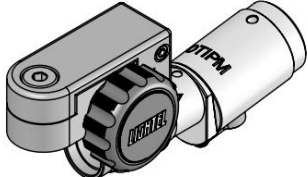
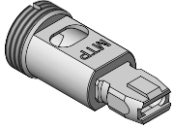
Lightel Technologies Series 2 Probe Tips

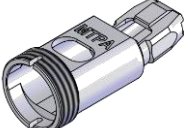
MTP/MPO

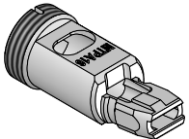
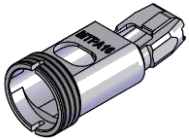
<p>Series 2 extended probe tip for MTP/MPO 12 fiber PC type connectors (male and female)</p>	<p>PT2-MTP/PC-EXT</p>		
<p>Series 2 extended probe tip for MTP/MPO 12 fiber APC type connectors (male and female)</p>	<p>PT2-MTP/APC-EXT</p>		
<p>Series 2 extended probe tip for 12/48 fiber single and multi-row MTP/MPO PC type connectors (male and female)</p>	<p>PT2-MTP/PC-XY-EXT</p>		
<p>Series 2 extended probe tip for 12/48 fiber single and multi-row MTP/MPO APC type connectors (male and female)</p>	<p>PT2-MTP/APC-XY-EXT</p>		
<p>Series 2 extended probe tip for 12/24 fiber single and multi-row Neutrik opticalCON MTP connectors (male and female)</p>	<p>PT2-MTP/PC/OCON-XY-EXT</p>		
<p>Series 2 extended probe tip for 12/48 fiber single and multi-row Neutrik opticalCON MTP APC connectors (male and female)</p>	<p>PT2-MTP/APC/OCON-XY-EXT</p>		

Lightel Technologies Series 2 Probe Tips

<p>Series 2 extended probe tip body for single and multi-row MTP/MPO connectors</p>	<p>PT2-MTP-XY-EXT</p>		
<p>Series 2 probe tip for OptiTip® APC type connectors (male and female)</p>	<p>PT2-OTIP/APC</p>		
<p>Front end piece for MTP/MPO 12/48 fiber female PC connectors</p>	<p>PT2-MTP/PC-T</p>		
<p>Front end piece for MTP/MPO 12/48 fiber female APC connectors</p>	<p>PT2-MTP/APC-T</p>		
<p>Front end piece for MTP/MPO 16/64 fiber female PC connectors</p>	<p>PT2-MTP/PC-T16</p>		
<p>Front end piece for MTP/MPO 16/64 fiber female APC connectors</p>	<p>PT2-MTP/APC-T16</p>		
<p>Adapter for MTP/MPO 12/48 fiber male PC connectors and MT ferrules</p>	<p>PT2-MT/ADAPT/M</p>		
<p>Adapter for MTP/MPO 12/48 fiber male APC connectors and MT ferrules</p>	<p>PT2-MT/ADAPT/APC/M</p>		

MTP/MPO (Cont'd)

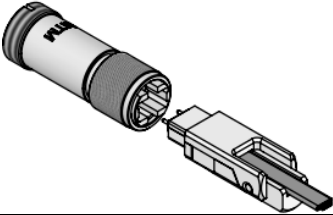
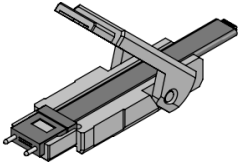
<p>Holder for MT ferrules for use with PT2-MT/ADAPT... adapters</p>	<p>AV4-BF</p>		
---	---------------	--	---

MTP/MPO (Cont'd)

Lightel Technologies Series 2 Probe Tips

Straight Extended PC Tips are all available in 3 lengths:

Short (S) approximately 60mm



Medium (M) approximately 100mm



Long (L) approximately 150mm



(For exact dimensions for individual tips contact Lightel or your Lightel distributor)

Series 2 extended probe tips for FC and SC PC type female connectors	PT2-FS/PC/F-S PT2-FS/PC/F-M PT2-FS/PC/F-L	<i>Medium length pictured</i>	
Series 2 extended probe tips for ST PC type female connectors	PT2-ST/PC/F-S PT2-ST/PC/F-M PT2-ST/PC/F-L	<i>Medium length pictured</i>	
Series 2 extended probe tips for E2K PC type female connectors	PT2-E2K/PC/F-S PT2-E2K/PC/F-M PT2-E2K/PC/F-L	<i>Medium length pictured</i>	
Series 2 extended probe tips for LC PC type female connectors	PT2-LC/PC/F-S PT2-LC/PC/F-M PT2-LC/PC/F-L	<i>Medium length pictured</i>	
Series 2 extended probe tips for MU PC type female connectors	PT2-MU/PC/F-S PT2-MU/PC/F-M PT2-MU/PC/F-L	<i>Medium length pictured</i>	
Series 2 extended probe tips for SC2 PC type female connectors	PT2-SC2/PC/F-S PT2-SC2/PC/F-M PT2-SC2/PC/F-L	<i>Medium length pictured</i>	
Series 2 short extended probe tip for URM PC type female connectors	PT2-URM/PC/F-S		

Straight Extended PC Bulkhead Tips

Lightel Technologies Series 2 Probe Tips

Angled Bulkhead Tips

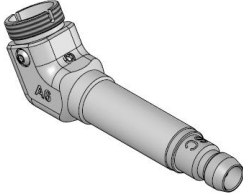
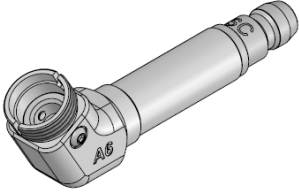
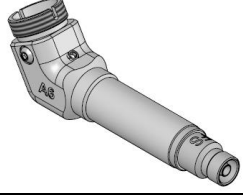
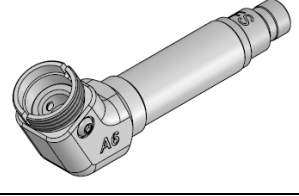
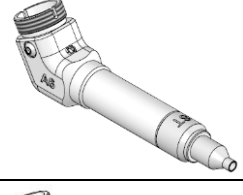
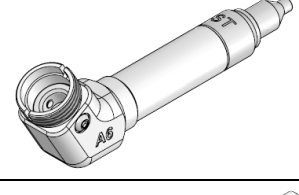
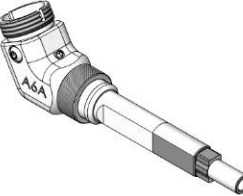
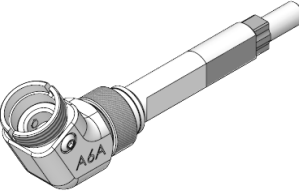
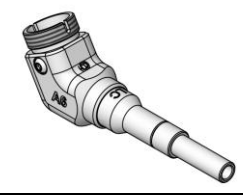
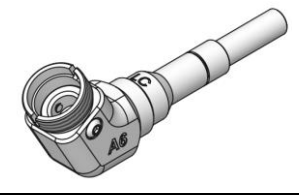
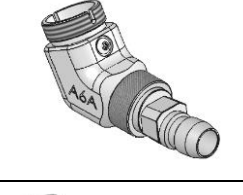
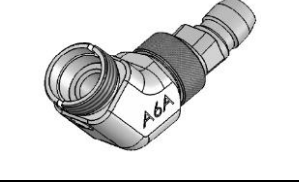
Series 2 60° angled probe tip for SC PC type female connectors	PT2-SC/PC/F-A6		
Series 2 60° angled probe tip for FC and SC PC type female connectors	PT2-FS/PC/F-A6		
Series 2 60° angled probe tip for ST PC type female connectors	PT2-ST/PC/F-A6		
Series 2 60° angled probe tip for MU PC type female connectors	PT2-MU/PC/F-A6		
Series 2 60° angled probe tip for LC PC type female connectors	PT2-LC/PC/F-A6		
Series 2 60° angled probe tip for SC APC type female connectors	PT2-SC/APC/F-A6		
Series 2 60° angled probe tip for Corning Evolv Hardened Connectivity Terminals	PT2-EVOLV/APC/F-A6P	