

# CURRENT TRANSFORMER

Model 781

Window Diameter 6.50"

APPLICATION:  
Relaying and metering.

FREQUENCY:  
50-400 Hz.

INSULATION LEVEL:  
0.6 kV, BIL 10 kV full wave.  
REGULATORY AGENCY APPROVALS



Manufactured to meet the requirements of ANSI/IEEE C57.13.  
Classified by U.L. in accordance with IEC 44-1.

METERING ACCURACY AND  
CONTINUOUS THERMAL  
CURRENT RATING FACTOR:  
See curves.

- Secondary terminals are brass screws No. 10-32 with one flatwasher and lockwasher, accessible from either side.
- Approximate weight 31 lbs.

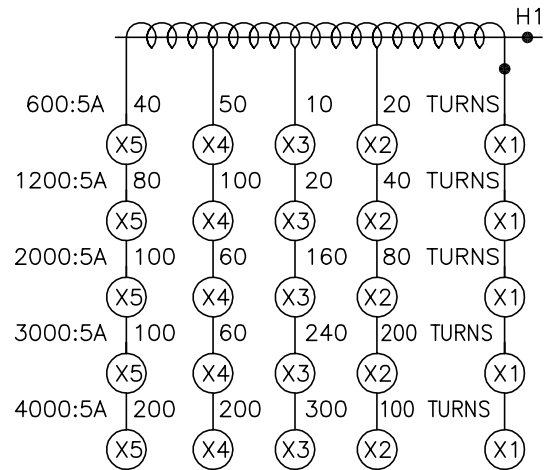
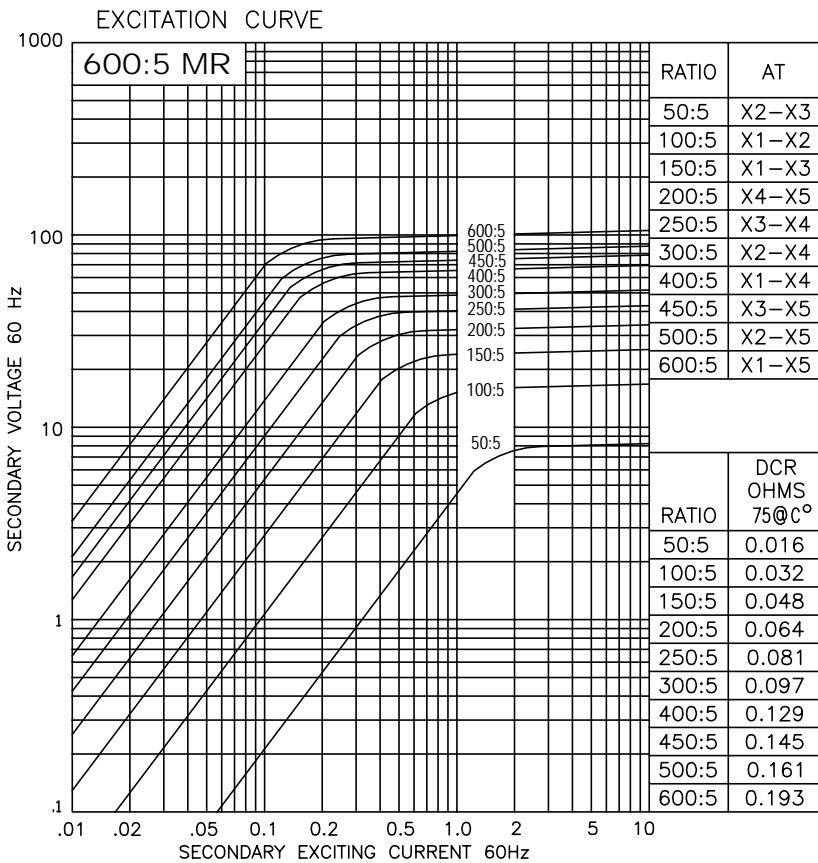
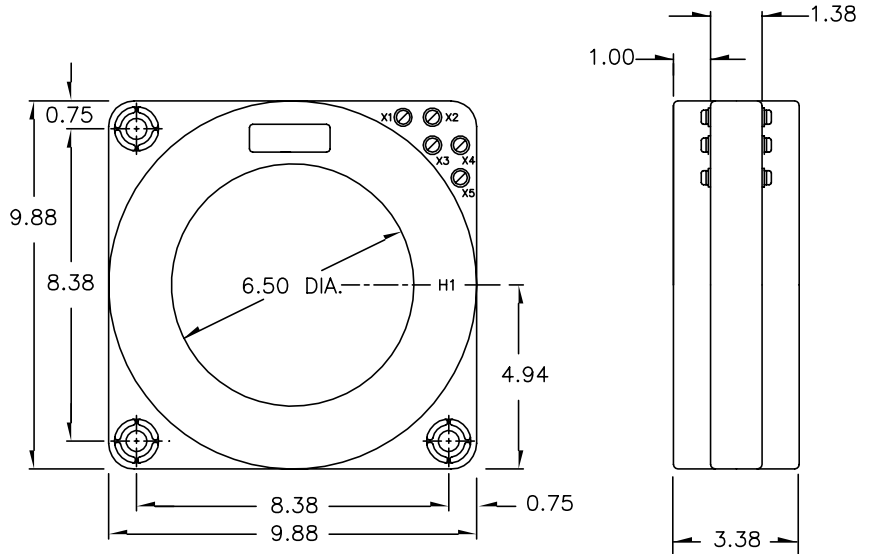
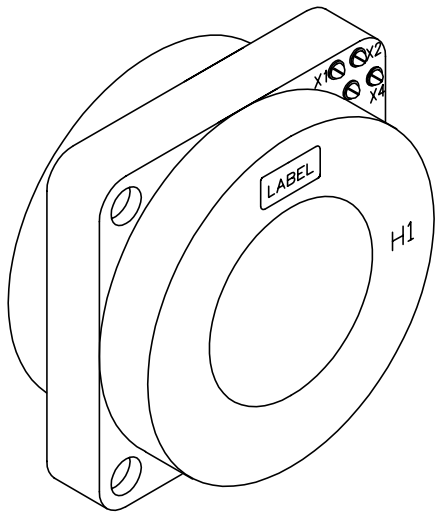

CONNECTION DIAGRAM

MODEL 781 - 601MR  
METERING ACCURACY: 0.3B0.5 - RATING C100  
TRF = 2.0 @ 30°C, 1.5 @ 55°C

# TYPICAL EXCITATION CURVES - MODEL 781

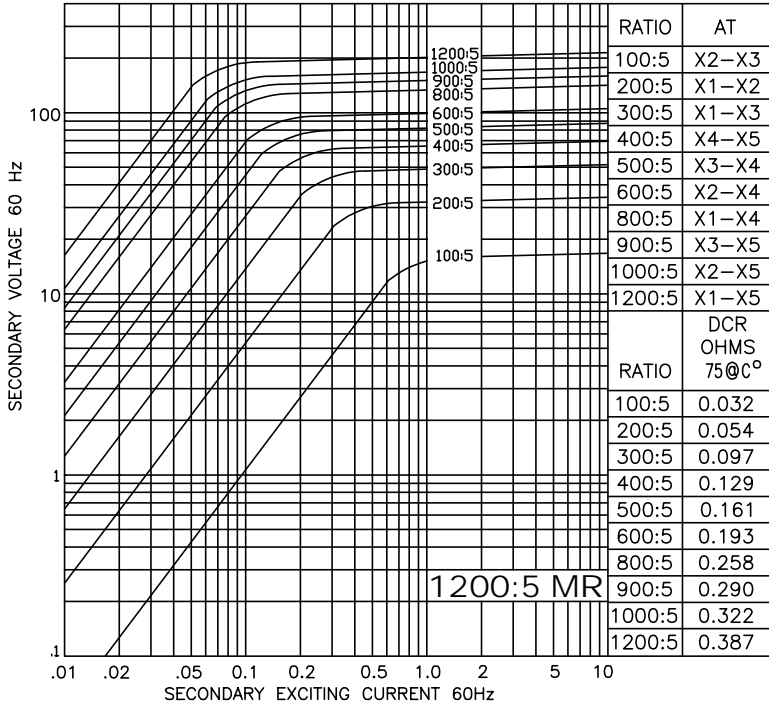

**MODEL 781 - 122MR**  
 METERING ACCURACY: 0.3B1.8 - RATING C200  
 TRF= 2.0 @ 30°C, 1.5 @ 55°C

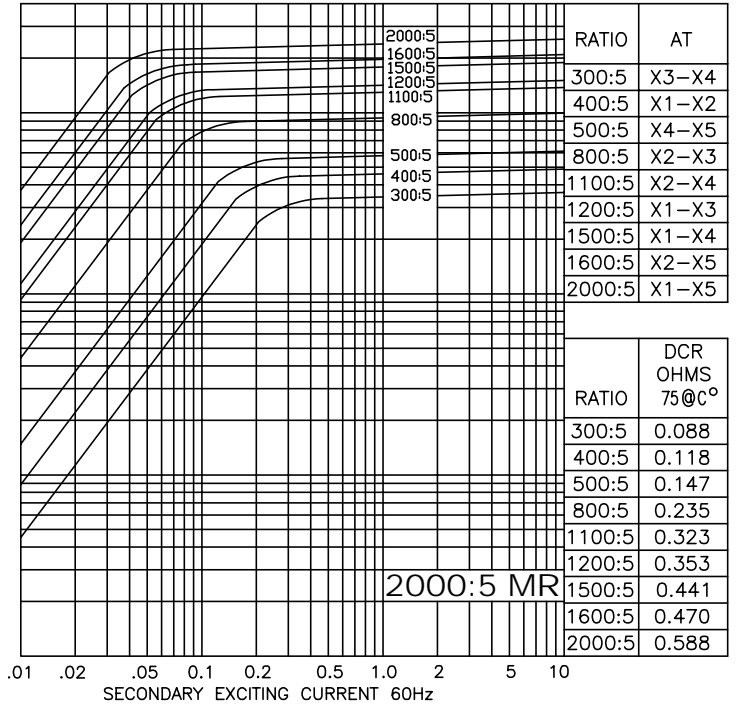

**MODEL 781 - 202MR**  
 METERING ACCURACY: 0.3B1.8 - RATING C200  
 TRF= 2.0 @ 30°C, 1.5 @ 55°C

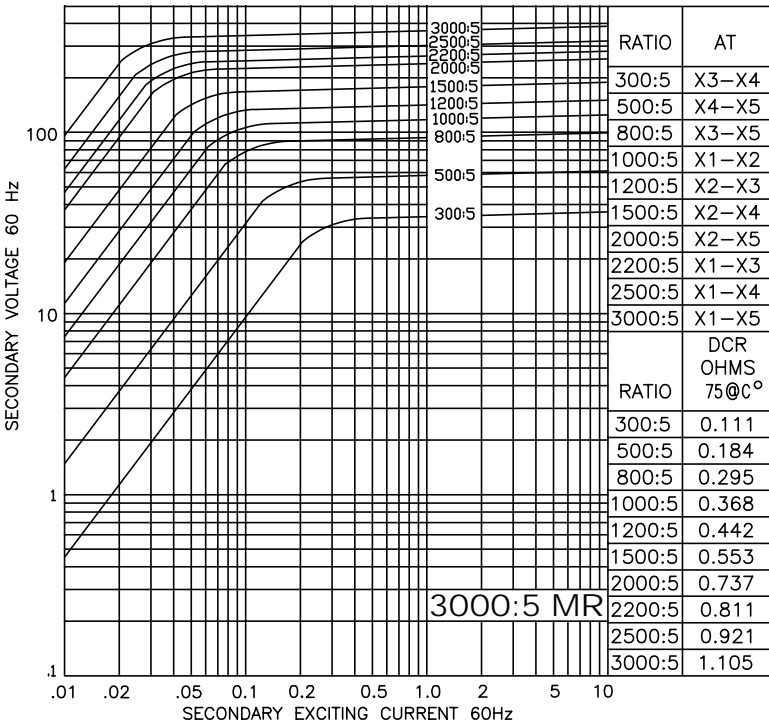

**MODEL 781 - 302MR**  
 METERING ACCURACY: 0.3B1.8 - RATING C200  
 TRF= 1.5 @ 30°C, 1.33 @ 55°C

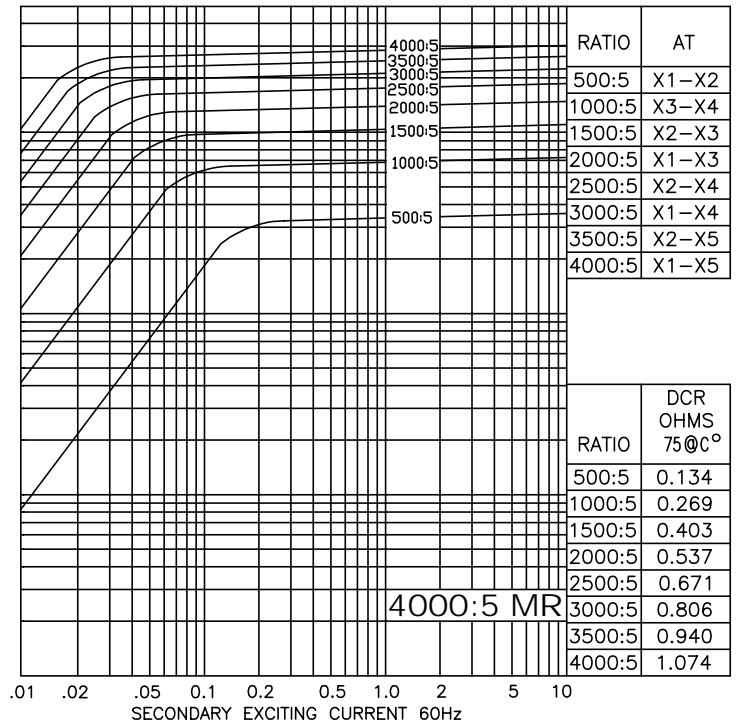

**MODEL 781 - 402MR**  
 METERING ACCURACY: 0.3B1.8 - RATING C200  
 TRF= 1.5 @ 30°C, 1.33 @ 55°C